

INDIGO

LIGHTING

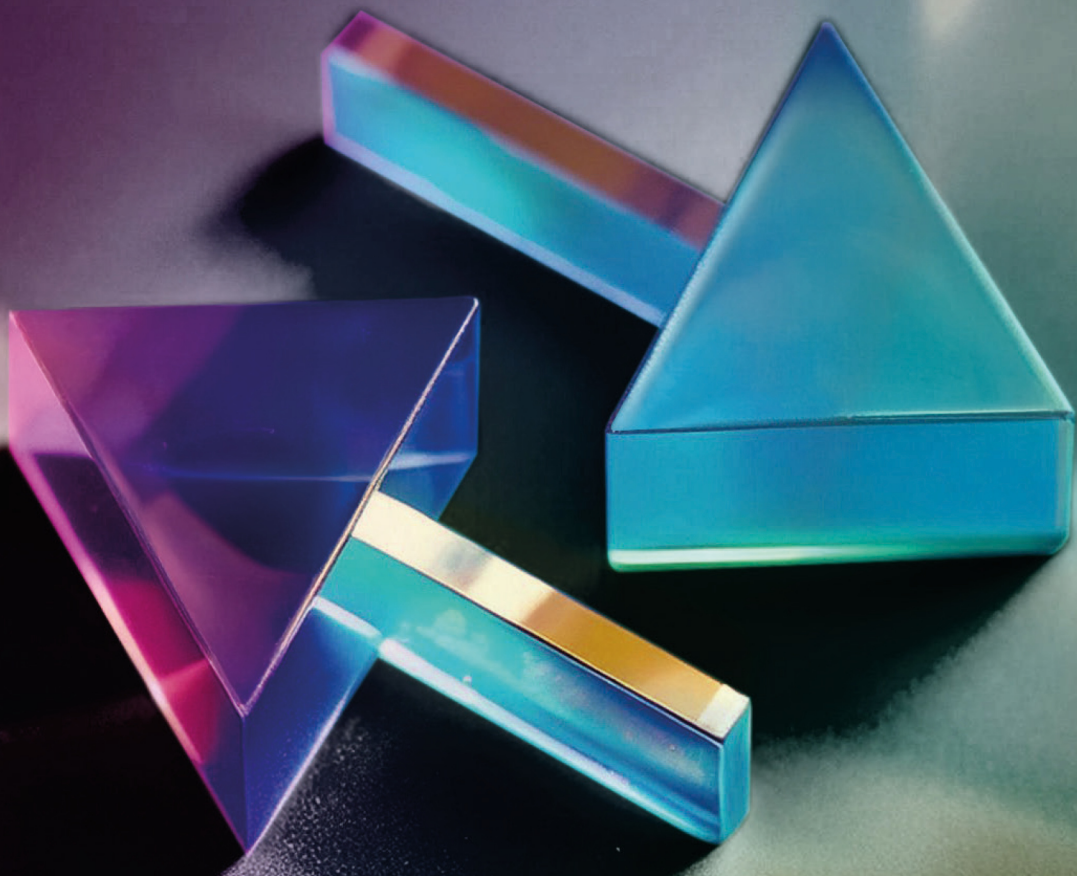

2025



INDIGO

LIGHTING

INDIGO S. A.

Parc Artisanal de Cornemont
Rue de la Légende 32G
4141 Sprimont
BELGIQUE

T : +32 (0)4 351 91 40
F : +32 (0)4 351 91 41
info@indigo-lighting.com

indigo-lighting.com



INDIGO



LIGHTING

INTÉRIEUR



EXTÉRIEUR



ACCESSOIRES



NOUVEAUTÉS



NEW
RETI 1 RX
94



NEW
RETI 2 RX
94



NEW
DECO TRACK 48 S
330



NEW
TORO T
332



NEW
TORO TP
332



NEW
SANDO T
333



NEW
SANDO TP
333



NEW
YOKO 2
340



NEW
YOKA 3
341



NEW
YOKO 3
341



NEW
YOKA 4
342



NEW
YOKO 4
342



NEW
MEKA
347



NEW
POLAS VERSA
372



NEW
CAIMAN VERSA
373



NEW
CAIMAN VERSA
QUICK CONNECT
374



NEW
GL038 II
405



NEW
TILT 1
408



NEW
TILT 2
409



NEW
TILT 3
410



NEW
TILT 4
411



NEW
SLIM
450



NEW
HYDRA
453

BORA RD-230 EVO	52
BORA RD EVO	54
BORA RDH EVO	58
BORA RDX-230 EVO	53
BORA RDX EVO	56
BORA SD EVO	55
BORA SDX EVO	57
BORU 1	345
BORU 2	345
BORU 3	346
BORU 4	346
CAIMAN QUICK CONNECT ..	374
CAIMAN VERSA	373
DALMA T	334
DECO TRACK 48 L	326
DECO TRACK 48 M	328
DECO TRACK 48 S	330
DISU 1	336
DISU 2	337
GL016 F II	401
GL016 II	400
GL019 F II	395
GL019 II	394
GL019 LG II	396
GL019 ULG II	397
GL038 II	405
GL040 II	403
GL040 ULG II	404
GL100 II	414
H2 PRO EXTREME CSP	535
HUBA P	226
HULA C	204
HULA P	227
HYDRA	453
MEKA	347
POLAS VERSA	372
RAITO 1	344
RAITO 2	344
RETI 1 RX	94
RETI 2 RX	94
RETI P	222
RETI W	152
SANDO T	333
SANDO TP	333
SL220 MAINS II	432
SLIM	450
SPOTTY 1 P	426
SPOTTY 1 W	476
SPOTTY 2 P	427
SPOTTY 2 W	477
SPOTTY 3 W	477
STEPBEAM	144
SWEET RD EVO	70
TILT 1	408
TILT 2	409
TILT 3	410
TILT 4	411
TILT 5	412
TOMA	343
TOMO	343
TONKA	335
TORO T	332
TORO TP	332
YOKA 1	339
YOKA 2	340
YOKA 3	341
YOKA 4	342
YOKO 1	339
YOKO 2	340
YOKO 3	341
YOKO 4	342
ZUMU	338



LUMINAIRES INTÉRIEURS

COLLERETTES	22
SPOTS	34
SEMI-ENCASTRÉS	82
DOWNLIGHTS	102
DALLES LED	126
ENCASTRÉS MURAUX	136
APPLIQUES	146
PLAFONNIERS	174
SUSPENSIONS	216
BANDEAUX & PROFILS	238
RAILS & PROJECTEURS	264
LIGNES CONTINUES	348
HUBLOTS	358
RÉGLETTES ÉTANCHES	370
HIGH BAY	376



LUMINAIRES EXTÉRIEURS

ENCASTRÉS DE SOL	388
SPOTS SUR PIQUETS	416
BORNES	436
ENCASTRÉS MURAUX	458
APPLIQUES	464
PLAFONNIERS	500
PROJECTEURS	514
SPOTS	530
SOLAIRES	536

INDIGO

LIGHTING

ACCESSOIRES

SOURCES, DOUILLES ET CÂBLES	542	PICTOGRAMMES	574
ALIMENTATIONS	548	INDEX GÉNÉRAL	576
GESTION D'ÉCLAIRAGE	554		
BOÎTES DE RACCORDEMENT ET CONNECTEURS IP	562		

COLLERETTES

KASA R GU10	KASA RX GU10	ALA1013 RX GU10 AUTO	ALA1013 SX GU10 AUTO	BALI R GU10	FIJI R GU10	COMO RX GU10	HD1050 R GU10	HD1070 R GU5.3
24	24	26	27	28	28	29	30	30

SPOTS

TIBLI R-B	LASY RX	SPOTI R-B	KALI R-230 B	KACI R-B	LISY RD	LISY RDX	MOWI RD	TIPI RX
36	36	37	38	39	40	40	41	42
DEBI RD-230	DEBI RD	IENA RDX-230	IENA RDX	NEW BORA RD-230 EVO	NEW BORA RDX-230 EVO	NEW BORA RD EVO	NEW BORA SD EVO	NEW BORA RDX EVO
48	48	50	50	52	53	54	55	56
AL1014 RX	AL1014 RDX	AL2014 SDX	AL1015 RX	LARY RD	LARY SD	IPHO 82 RD	IPHO 82 SD	COPE RD
64	64	65	65	66	66	67	67	68
AL3012 RD WARM	SYLA RD-B	ABY 1 RD	ABY 2 RD	ABY 3 RD	ALLY 3 RDX	ALLY 4 RDX	DOTS	
74	75	76	76	77	78	78	80	

SEMI-ENCASTRÉS

SIRA R	SIRA R SENSOR	FILI 1 RX GU10 AUTO	FILI 5 RX-B GU10 AUTO	OKTO RX GU10	CLARA 1 RDX	CLARA 2 RDX	ALLY 1 RX	ALLY 1 RDX
84	84	86	86	87	88	88	90	90
NEW RETI 2 RX	EDDY RX	JOY RX	FILI 1 RX-B	FILI 5 RX-B	DEAN RDX PLUS	KARL 1 RDX	KARL 2 RDX	
94	96	97	98	98	99	100	100	

DOWNLIGHTS

DAX RD-230	SENSO R-230	TIGA 1 RD	TIGA 2 RD	TIGA 3 RD	THEA LITE CSP 1	THEA LITE CSP 2	THEA LITE CSP 3	FOX 2 RD
104	104	106	106	107	108	109	110	111
LYON 3 R	LYON 4 R	IZA 1 SDX	IZA 2 SDX	SPIRA 1 RX PLUS	SPIRA 3 RX	FOCEA 1 SX PLUS	FOCEA 2 SX	
117	118	120	120	122	123	124	124	

COLLERETTES



IPHO R GU10
AUTO
32



IPHO S GU10
AUTO
32

ALA1013 RX GU10 AUTO	26	HD1070 R GU5.3.....	30
ALA1013 SX GU10 AUTO	27	IPHO R GU10 AUTO.....	32
BALI R GU10.....	28	IPHO S GU10 AUTO.....	32
COMO RX GU10.....	29	KASA R GU10.....	24
FIJI R GU10.....	28	KASA RX GU10.....	24
HD1050 R GU10.....	30		

SPOTS



TIPI SX
42



BRAVA RD-230
44



BRAVA RDH-230
44



MARY RDX-230
46



ALIS 1014 RDX
46



NEW
BORA SDX EVO
57



NEW
BORA RDH EVO
58



ALEX RDX
60



KORY R
62



KORY R SENSOR
62



EPI RD
68



NEW
SWEET RD EVO
70



SILK RDX
72



SILK RDX WARM
73



AL3012 RD
74

ABY 1 RD.....	76	EPI RD.....	68
ABY 2 RD.....	76	IENA RDX.....	50
ABY 3 RD.....	77	IENA RDX-230.....	50
AL1014 RDX.....	64	IPHO 82 RD.....	67
AL1014 RX.....	64	IPHO 82 SD.....	67
AL1015 RX.....	65	KACI R-B.....	39
AL2014 SDX.....	65	KALI R-230 B.....	38
AL3012 RD.....	74	KORY R.....	62
AL3012 RD WARM.....	74	KORY R SENSOR.....	62
ALEX RDX.....	60	LARY RD.....	66
ALIS 1014 RDX.....	46	LARY SD.....	66
ALLY 3 RDX.....	78	LASY RX.....	36
ALLY 4 RDX.....	78	LISY RD.....	40
BORA RD-230 EVO.....	52	LISY RDX.....	40
BORA RD EVO.....	54	MARY RDX-230.....	46
BORA RDH EVO.....	58	MOWI RD.....	41
BORA RDX-230 EVO.....	53	SILK RDX.....	72
BORA RDX EVO.....	56	SILK RDX WARM.....	73
BORA SD EVO.....	55	SPOTI R-B.....	37
BORA SDX EVO.....	57	SWEET RD EVO.....	70
BRAVA RD-230.....	44	SYLA RD-B.....	75
BRAVA RDH-230.....	44	TIBLI R-B.....	36
COPE RD.....	68	TIPI RX.....	42
DEBI RD.....	48	TIPI SX.....	42
DEBI RD-230.....	48		
DOTS.....	80		

SEMI-ENCASTRÉS



ALLY 2 RX
91



ALLY 2 RDX
91



CLIC RDX MINI
92



CLIC RDX
92



NEW
RETI 1 RX
94

ALLY 1 RDX.....	90	FILI 5 RDX-B.....	98
ALLY 1 RX.....	90	FILI 5 RX-B GU10 AUTO.....	86
ALLY 2 RDX.....	91	JOY RX.....	97
ALLY 2 RX.....	91	KARL 1 RDX.....	100
CLARA 1 RDX.....	88	KARL 2 RDX.....	100
CLARA 2 RDX.....	88	OKTO RX GU10.....	87
CLIC RDX.....	92	RETI 1 RX.....	94
CLIC RDX MINI.....	92	RETI 2 RX.....	94
DEAN RDX PLUS.....	99	SIRA R.....	84
EDDY RX.....	96	SIRA R SENSOR IR.....	84
FILI 1 RX-B.....	98		
FILI 1 RX GU10 AUTO.....	86		

DOWNLIGHTS



AL1016 RX
112



THEA PRO 1
113



THEA PRO 2
114



LYON 1 R
115



LYON 2 R
116

AL1016 RX.....	112	SPIRA 1 RX PLUS.....	122
DAX RD-230.....	104	SPIRA 3 RX.....	123
FOCEA 1 SX PLUS.....	124	THEA LITE CSP 1.....	108
FOCEA 2 SX.....	124	THEA LITE CSP 2.....	109
FOX 2 RD.....	111	THEA LITE CSP 3.....	110
IZA 1 SDX.....	120	THEA PRO 1.....	113
IZA 2 SDX.....	120	THEA PRO 2.....	114
LYON 1 R.....	115	TIGA 1 RD.....	106
LYON 2 R.....	116	TIGA 2 RD.....	106
LYON 3 R.....	117	TIGA 3 RD.....	107
LYON 4 R.....	118		
SENSO R-230.....	104		

DALLES LED



SOLIS 1 128 SOLIS PRO 129 SOLIS PRO CSP 130 SOLIS IP65 131 SOLIS 2 132 SOLIS 3 133 DOMINO 134 DOMINO CSP 135

ENCASTRÉS MURAUX



KO703 R 138 KO703 S 138 EVA 65 R 140 EVA 65 S 140 LIKA 142 MAKA 143 **NEW** STEPBEAM 144

APPLIQUES



VIA G9 148 VITEL GX53 148 OKTO 2 GU10 149 SNOOP GU10 150 SNOOP 150 **NEW** RETI W 152 AUREA 1 W 154 AUREA 2 W 155 AUREA 3 W 156
KAVA 162 FULLA 163 GLAM 265 164 GLAM 90 164 GLAM 250 165 BIXBY 166 ELLA 167 FOLD 1 168 FOLD 2 168

PLAFONNIERS



ALBA R GU10 176 ALBA S GU10 176 LUPO 1 GU10 178 MANYL 2 GU10 179 MANYL 2 179 MOLY GU10 180 NOLY GU10 180 YUKO GU10 181 OKTO GU10 182
RIVA 3 GU10 187 RIVA 4 GU10 188 EVA 62 R 189 EVA 62 S 189 HAPPY 1 191 HAPPY 2 192 HAPPY 3 193 AUREA 1 C 195 AUREA 2 C 196
PIXA 3 201 TIPO 1 C 202 TIPO 2 C 202 **NEW** HULA C 204 JUNE 1 C 206 JUNE 2 C 206 JUNE 3 C 207 CAPRI R 1 C 208 CAPRI R 2 C 209
NOVA CSP 3 C 213 DOTS C 214 TOMY 1 C 215

DALLES LED

DOMINO	134	SOLIS IP65.....	131
DOMINO CSP	135	SOLIS PRO	129
SOLIS 1	128	SOLIS PRO CSP	130
SOLIS 2	132		
SOLIS 3	133		

ENCASTRÉS MURAUX

EVA 65R.....	140	MAKA.....	143
EVA 65S.....	140	STEPBEAM.....	144
KO 703R.....	138		
KO 703S.....	138		
LIKA	142		

APPLIQUES

AUREA 1 W	154	MALTA 1.....	169
AUREA 2 W	155	MALTA 2.....	169
AUREA 3 W	156	MILO 1	158
AUREA 4 W	157	MILO 2	159
BIXBY	166	MILO 3	160
ELLA	167	MILO 4	160
EVIA G9	148	OKTO 2 GU10	149
FOLD 1	168	PLANK 1	172
FOLD 2	168	PLANK 2	173
FULLA	163	RETI W	152
GLAM 90.....	164	SNOOP.....	150
GLAM 250.....	165	SNOOP GU10.....	150
GLAM 265.....	164	VITEL GX53.....	148
KAVA.....	162		
LONGA.....	170		



PLAFONNIERS

ALBA R GU10.....	176	MANYL 2.....	179
ALBA S GU10.....	176	MANYL 2 GU10	179
AUREA 1 C	195	MOLY GU10.....	180
AUREA 2 C	196	NOLY GU10.....	180
CAPRI R 1 C	208	NOVA CSP 1 C.....	212
CAPRI R 2 C	209	NOVA CSP 2 C.....	212
CAPRI R 3 C	210	NOVA CSP 3 C.....	213
CAPRI S 1 C	211	OKTO 1 C GU10.....	184
CAPRI S 2 C	211	OKTO 2 C GU10.....	185
CLAC	198	OKTO 4 C GU10.....	186
CLAC 1 MINI	197	OKTO C GU10.....	183
CLAC 2 MINI	197	OKTO GU10	182
DOTS C	214	PIXA 1	200
EVA 62 R.....	189	PIXA 2	200
EVA 62 S.....	189	PIXA 3	201
HAPPY 1.....	191	RIVA 2 GU10	187
HAPPY 2.....	192	RIVA 3 GU10	187
HAPPY 3.....	193	RIVA 4 GU10	188
HULA C	204	TIPO 1 C	202
JUNE 1 C	206	TIPO 2 C	202
JUNE 2 C	206	TOMY 1 C	215
JUNE 3 C	207	YUKO GU10	181
LUPO 1 GU10.....	178		



SUSPENSIONS



BANDEAUX & PROFILS



1 ALLUMAGE



3 ALLUMAGES



RAILS & PROJECTEURS

ARCHITECTURAUX



TRACK 48 VDC

DECO TRACK 48

SUSPENSIONS



JUNE 2 P 228 JUNE 3 P 229 CAPRI R 1 P 230 CAPRI R 2 P 230 CAPRI R 3 P 231

AUREA P	219	JUNE 2 P	228
CAPRI R 1 P	230	JUNE 3 P	229
CAPRI R 2 P	230	NOVA CSP 1 P	234
CAPRI R 3 P	231	NOVA CSP 2 P	234
CAPRI S 1 P	232	NOVA CSP 3 P	235
CAPRI S 2 P	232	OKTO P GU10	218
HELLO 1 P	224	OTIS 2 P	237
HELLO 2 P	224	RETI P	222
HUBA P	226	TOMY 1 P	236
HULA P	227	TOMY 2 P	236
JACK 3 P	220		
JUNE 1 P	228		



ST125 250 ST160 251 ST135 252
PR135 262 PR137 263

BANDEAUX & PROFILS

PR115	254	ST123	248
PR117	256	ST125	250
PR121	257	ST132	249
PR127	258	ST135	252
PR130	259	ST150	243
PR133	261	ST153	244
PR135	262	ST156	245
PR137	263	ST159	247
PR139	255	ST160	251
PR146	260		
ST104	242		
ST112	246		

RAILS & PROJECTEURS

1 ALLUMAGE

JACK T	272	TRACK UNO	266
JACK TP	273	TRACK UNO	267
OKTO T GU10	270	YERA 1 T GU10	268
OKTO TP GU10	270	YERA 1 TP GU10	268
RAY	274		

3 ALLUMAGES

AUREA 3 T	284	LINEA 1	300
AUREA 3 TP	285	LINEA 2	300
FOCAL	291	OKTO 3 T GU10	282
FOCUS	291	OKTO 3 TP GU10	283
HELLO 1 D	286	OSIS 1 PLUS	289
HELLO 2 D	286	OSIS 2 PLUS	289
JACK 3 T	292	TED	290
JACK 3 TP	294	TRACK III SURFACE	278
LIMA 1 PLUS	296	TRACK III SURFACE	279
LIMA 2 PLUS	297	YERA GU10	280
LIMA 3 PLUS	298	ARRAS	320

ARCHITECTURAUX

TRACK 48 VDC

BERN	319	LOOP 2	311
CADIX	318	ONEX	317
IRO 1	322	PARO 1	312
IRO 2	322	PARO 2	313
KARO 1	308	PARO 3	314
KARO 2	308	TRACK 48VDC RECESSED	306
KARO 3	309	TRACK 48VDC SURFACE	304
LEGA D	320	VIGO	316
LOOP 1	311		

NEW

DECO TRACK 48

BORU 1	345	TOMA	343
BORU 2	345	TOMO	343
BORU 3	346	TONKA	335
BORU 4	346	TORO T	332
DALMA T	334	TORO TP	332
DECO TRACK 48 L	326	YOKA 1	339
DECO TRACK 48 M	328	YOKA 2	340
DECO TRACK 48 S	330	YOKA 3	341
DISU 1	336	YOKA 4	342
DISU 2	337	YOKO 1	339
MEKA	347	YOKO 2	340
RAITO 1	344	YOKO 3	341
RAITO 2	344	YOKO 4	342
SANDO T	333	ZUMU	338
SANDO TP	333		

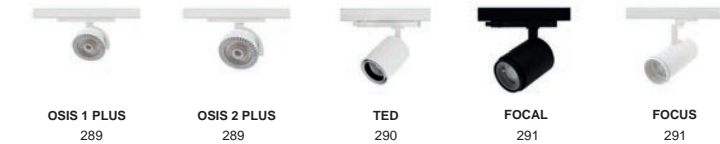

OSIS 1 PLUS 289 OSIS 2 PLUS 289 TED 290 FOCAL 291 FOCUS 291



PARO 3 314 VIGO 316 ONEX 317 CADIX 318 BERN 319



DISU 1 336 DISU 2 337 ZUMU 338 YOKA 1 339 YOKO 1 339



RAITO 2 344 BORU 1 345 BORU 2 345 BORU 3 346 BORU 4 346 MEKA 347

LIGNES CONTINUES



LINEAR 1 C
352

LINEAR 2 C
353

LINEAR 1 P
354

LINEAR 2 P
356

HUBLOTS



MINI TIMY E27
360

MINI TIMY SENSOR E27
360

MINI TIMY
361

MINI TIMY SENSOR
361

TIMY
362

TIMY SENSOR
362

LIDY
364

LIDY SENSOR
364

RÉGLÉTTES ÉTANCHES

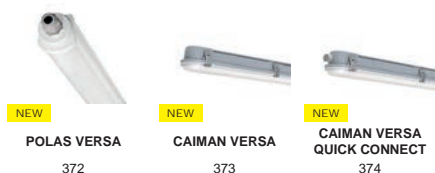

NEW
POLAS VERSA
372

NEW
CAIMAN VERSA
373

NEW
CAIMAN VERSA
QUICK CONNECT
374

HIGH BAY



EAZY
383

SPRINGBOK LITE 1
384

SPRINGBOK LITE 2
384

SPRINGBOK LITE 3
385

ENCASTRÉS DE SOL



KO2000 R GU10
390

TINY R
390

GL018 C
391

PURE 45
392

PURE 55
392

NEW
GL019 II
394

NEW
GL019 F II
395

NEW
GL019 LG II
396

PURE 380
402

NEW
GL040 II
403

NEW
GL040 ULG II
404

NEW
GL038 II
405

APA RD-230
406

BIG APA RD-230
406

GYRO
407

GYRO A
407

RODI A
413

BIG RODI A
413

NEW
GL100 II
414

GL200
415

SPOTS SUR PIQUETS



LUXI 65 GU10
418

TURA GU10
419

OLA 1
420

SL040A
421

RIESA
422

BRAMA 1
423

BRAMA 2
423

BASIL 1 P
424

GUNZY P
429

GUNZY 2 P
430

YUKA
431

ANDY
431

NEW
SL220 MAINS II
432

SL230 MAINS
433

SL240 MAINS
434

LIGNES CONTINUES

INEAR 1 C	352
LINEAR 1 P	354
LINEAR 2 C	353
LINEAR 2 P	356

HUBLOTS

LIDY	364	MINI TIMY SENSOR E27	360
LIDY A	366	ORKI	369
LIDY A SENSOR	366	ORKI SENSOR	369
LIDY SENSOR	364	TIMY	362
MINI TIMY	361	TIMY SENSOR	362
MINI TIMY E27	360	WL94	368
MINI TIMY SENSOR	361		

RÉGLETTES ÉTANCHES

CAIMAN QUICK CONNECT	374
CAIMAN VERSA	373
POLAS VERSA	372

HIGH BAY

EAZY	383
SPRINGBOK LITE 1	384
SPRINGBOK LITE 2	384
SPRINGBOK LITE 3	385

ENCASTRÉS DE SOL

APA RD-230	406	PURE 380	402
BIG APA RD-230	406	RODI A	413
BIG RODI A	413	SWIM	398
GL016 F II	401	TILT 1	408
GL016 II	400	TILT 2	409
GL018 C	391	TILT 3	410
GL019 F II	395	TILT 4	411
GL019 II	394	TILT 5	412
GL019 LG II	396	TINY R	390
GL019 ULG II	397	WALLY A	399
GL038 II	405		
GL040 II	403		
GL040 ULG II	404		
GL100 II	414		
GL200	415		
GYRO	407		
GYRO A	407		
KO2000 R GU10	390		
PURE 45	392		
PURE 55	392		



LIDY A 366 LIDY A SENSOR 366 WL94 368 ORKI 369 ORKI SENSOR 369



NEW GL019 ULG II 397 SWIM 398 WALLY A 399 NEW GL016 II 400 NEW GL016 F II 401

NEW TILT 1 408 NEW TILT 2 409 NEW TILT 3 410 NEW TILT 4 411 NEW TILT 5 412



BASIL 2 P 424 BASIL 3 P 425 NEW SPOTTY 1 P 426 NEW SPOTTY 2 P 427 GUNZY 428

SPOTS SUR PIQUETS

ANDY	431	SL220 MAINS II	432
BASIL 1 P	424	SL230 MAINS	433
BASIL 2 P	424	SL240 MAINS	434
BASIL 3 P	425	SPOTTY 1 P	426
BRAMA 1	423	SPOTTY 2 P	427
BRAMA 2	423	TURA GU10	419
GUNZY	428	YUKA	431
GUNZY 2 P	430		
GUNZY P	429		
LUXI 65 GU10	418		
OLA 1	420		
RIESA	422		
SL040A	421		

BORNES



ENCASTRÉS MURAUX



APPLIQUES



PLAFONNIERS



PROJECTEURS



BORNES



AMONT.....	444	LUXI 100 S P.....	448
AVI 1.....	454	LUXI 175 SENSOR P.....	443
AVI 2.....	454	LUXI 180.....	443
BENS P.....	449	LUXI 650.....	444
BREST.....	445	MINO P E27.....	438
CYCLO.....	456	OLA 2.....	448
CYCLO SENSOR.....	456	RAVEL.....	442
ELNE 1.....	440	RONDO P E27.....	438
ELNE 2.....	440	SETO.....	449
ELNE 4.....	441	SLIM	450
FILO P.....	452	STELLA.....	446
FINN P.....	447	TULO E27.....	439
HYDRA	453	TULO SENSOR E27.....	439
LUXI 54.....	442		
LUXI 80.....	451		

ENCASTRÉS MURAUX

ARTSY.....	463
DEVI.....	462
PURE 190.....	462
SLIT R.....	460
SLIT S.....	460

APPLIQUES

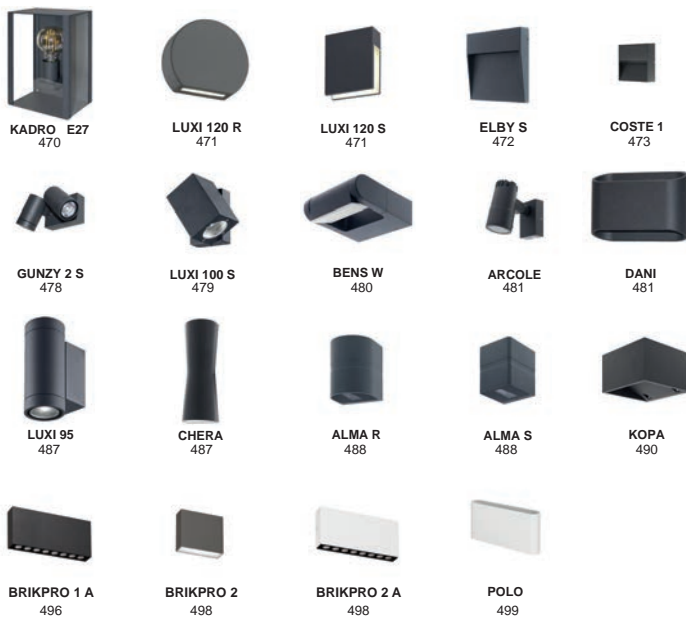

ALMA R.....	488	LUXI 45.....	482
ALMA S.....	488	LUXI 45 SENSOR.....	482
ALTEA 1 GU10.....	467	LUXI 95.....	487
ALTEA 2 GU10.....	467	LUXI 100 S.....	479
ALTO 1 GU10.....	466	LUXI 120 R.....	471
ALTO 2 GU10.....	466	LUXI 120 S.....	471
ARCOLE.....	481	LUXI 139.....	484
BENS W.....	480	LUXI 175 SENSOR.....	483
BRIKPRO 1.....	496	LUXI 190.....	486
BRIKPRO 1 A.....	496	LUXI 290.....	486
BRIKPRO 2.....	498	MINO W E27.....	469
BRIKPRO 2 A.....	498	NORA.....	494
CHERA.....	487	ONEO A.....	495
COSTE 1.....	473	POLO.....	499
COSTE 2.....	473	RONDO W E27.....	469
DANI.....	481	SPOTTY 1 W	476
EDGY.....	485	SPOTTY 2 W	477
ELBY S.....	472	SPOTTY 3 W	477
FINN W.....	474	WIDO.....	475
FURY S GU10.....	468		
GUNZY 2 S.....	478		
GUNZY S.....	478		
HARRY A.....	495		
HUGO GU10.....	468		
ITO.....	474		
KADRO E27.....	470		
KOPA.....	490		
KOS 1 S.....	492		
KOS 2 R.....	492		
KOS 2 S.....	493		
KUBO.....	491		
LANTERN.....	485		

PLAFONNIERS



ASPI 1 SENSOR PLUS.....	512	ROMY S GU10.....	502
ASPI 2 SENSOR PLUS.....	513	UNIS R.....	506
FARO 1.....	510	UNIS S.....	506
FARO 2.....	510		
ILY.....	505		
LEWIS.....	504		
LUZ 1.....	509		
LUZ 2.....	509		
ROMY R GU10.....	502		

PROJECTEURS



CURTIS PLUS.....	520	RAYPRO 14.....	526
CURTIS SENSOR PLUS.....	521	RAYPRO 32.....	526
INDY 1.....	522	RAYPRO 32 A.....	527
INDY 1 A.....	523	RAYPRO 50.....	528
INDY 2.....	524	RAYPRO 50 A.....	529
INDY 2 A.....	525		

SPOTS



ADA 1 RX
532



ADA 2 RX
532



AL3012 RD OUT
534

NEW



H2 PRO
EXTREME CSP
535

SOLAIRES



RAMA W
538



RAMA P
538



KALA
539

SOURCES, DOUILLES
ET CABLE



MODU LED
544



SUP 08 AUTO
545



WCR275BLACK
546

ALIMENTATIONS



CD155
550



CD170
550



PSIP3509W
550



CD114
550



PSIP35018W
550



CD172
550



PSIP70018W
550



CD105
550



PSIP70036W
550



CD125
550



NEW
DRV350700TD
550



CD123
551



CD124
551



PSDIM350
551



PLUNIDRIVE350MA
551



PSDAL350M
551



CD140
551



CD116
551



CD122
551



CD171
552



CD173
552



CD158
552



CD174
552



CD175
552



CD178
552



CD179
552



CD150
552



CD181
552



CD153
552



CD154
552

GESTION
D'ÉCLAIRAGE



CD136
556



CD135
557



CD141
558



CD142
559



CD156
560



LEDEP10
561

BOÎTES



WC59
564



JB1
565



JB2
566



JB4
567



JB5
568



JB6
569



JB7
570

SPOTS

ADA 1 RX.....	532
ADA 2 RX.....	532
AL3012 RD OUT.....	534
H2 PRO EXTREME CSP	535

SOLAIRES

KALA.....	539
RAMA P.....	538
RAMA W.....	538

SOURCES, DOUILLES ET CÂBLES

MODU LED.....	544
SUP 08 AUTO.....	545
WCR275BLACK.....	546

ALIMENTATIONS

CD155.....	550	PSDIM700.....	551
CD170.....	550	PSDAL700M.....	551
PSIP3509W.....	550	CD122.....	551
CD114.....	550	CD171.....	552
PSIP35018W.....	550	CD173.....	552
CD172.....	550	CD158.....	552
PSIP70018W.....	550	CD174.....	552
CD105.....	550	CD175.....	552
PSIP70036W.....	550	CD178.....	552
DRV150700.....	550	CD179.....	552
CD102.....	550	CD150.....	552
CD112.....	550	CD176.....	552
CD104.....	550	CD159.....	552
CD147.....	550	CD180.....	552
CD125.....	550	CD177.....	552
DRV350700TD.....	550	CD151.....	552
CD123.....	551	CD181.....	552
CD124.....	551	CD153.....	552
PLUNIDRIVE350MA.....	551	CD154.....	552
PSDIM350.....	551		
PSDAL350M.....	551		
CD140.....	551		
CD116.....	551		
CD126.....	551		
CD148.....	551		
PLDUNIDRIVE700MA.....	551		

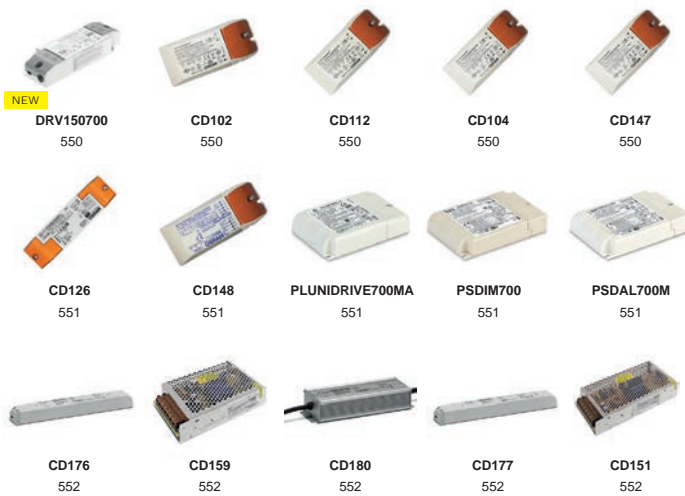

GESTION D'ÉCLAIRAGE

CD135.....	557	CD156.....	560
CD136.....	556	LEDEP10.....	561
CD141.....	558		
CD142.....	559		

BOÎTES DE RACCORDEMENT ET CONNECTEURS IP

JB1.....	565	JB6.....	569
JB2.....	566	JB7.....	570
JB4.....	567	WC59.....	564
JB5.....	568		

LUMINAIRES INTÉRIEURS



COLLERETTES

SPOTS

SEMI-ENCASTRÉS

DOWNLIGHTS

DALLES LED

ENCASTRÉS MURAUX

APPLIQUES

PLAFONNIERS

SUSPENSIONS

BANDEAUX & PROFILS

RAILS & PROJECTEURS

LIGNES CONTINUES



HUBLOTS



RÉGLETTES ÉTANCHES

HIGH BAY

CLASSEMENT PAR DIAMÈTRES D'ENCASTREMENT









COLLETTES	PAGE 2025	 (mm)	DIMENSIONS (mm)	IP X	 X°	Watt Max	12 V	230 V	RE 2020
KASA R GU10	24	60	78	23		10W		V	
ALA1013 RX GU10 AUTO	26	68	82	23	30°	10W		V	
ALA1013 SX GU10 AUTO	27	68	82x82	23	30°	10W		V	
HD1050 R GU10	30	68	82	65		10W		V	V
HD1070 R GU5.3	30	68	82	65		10W	V	V	V
IPHO R GU10 AUTO	32	68	83	44		10W		V	V
IPHO S GU10 AUTO	32	68	83x83	44		10W		V	V
KASA RX GU10	24	75	82	23	30°	10W		V	
BALI R GU10	28	75	83	20		10W		V	
COMO RX GU10	29	83	90	20	25°	10W		V	
FIJI R GU10	28	85	90	20		10W		V	

SPOTS	PAGE 2025	 (mm)	DIMENSIONS (mm)	IP X	 X°	CCT	LED	UGR <19	LED 230V	DIM	LAMELLES		RE 2020
TIBLI R-B	36	25	30	20			1,2W	V		En option	V		
SPOTI R-B	37	35	40	44			4,5W	V			V	V	
DOTS	80	39x35	48x44	20			3W	V		V			
LASY RX	36	42	52	44	30°		1W					V	
LISY RD	40	45	55	23			4,5W			V			
MOWI RD	41	45	55	23			6W	V		V			
KALI R-230 B	38	55	72	20			4,7W		V		V	V	
KACI R-B	39	55	70	44			3W				V	V	
TIPI RX	42	55	64	44	30°		3W					V	
TIPI SX	42	55	64x64	44	30°		3W					V	
LISY RDX	40	58	66	23	20°		4,5W			V			
KORY R	62	68	88	65		2700-3000-4000K	6W					V	V
KORY R SENSOR	62	68	88	65		2700-3000-4000K	6W					V	V
BRAVA RD-230	44	68	85	65		2700-3000-4000K	5W		V	V		V	V
BRAVA RDH-230	44	68	85	65		2700-3000-4000K	5W		V	V		V	V
DEBI RD-230	48	68	82	65		2700-3000-4000-6000K	5W		V	V		V	V
DEBI RD	48	68	82	65		2700-3000-4000-6000K	6W			V		V	V
IENA RDX-230	50	68	82	65	30°	2700-3000-4000-6000K	5W		V	V		V	V
IENA RDX	50	68	82	65	30°	2700-3000-4000-6000K	6W		V	V		V	V
BORA RD-230 EVO	52	68	86	65		2700-3000-4000-6000K	5W		V	V		V	V
BORA RD EVO	54	68	86	65		2700-3000-4000-6000K	7W			V		V	V
BORA SD EVO	55	68	86x86	65		2700-3000-4000-6000K	7W			V		V	V
BORA RDH EVO	56	68	86	65		2700-3000-4000-6000K	7W		V	V		V	V
BORA RDX-230 EVO	53	68	86	65	25°	2700-3000-4000-6000K	5W		V	V		V	V
BORA RDX EVO	58	68	86	65	25°	2700-3000-4000-6000K	7W			V		V	V
BORA SDX EVO	57	68	86x86	65	25°	2700-3000-4000-6000K	7W			V		V	V
ALEX RDX	60	68	85	65	25°	2700-3000-4000-6500K	6W			V		V	V
AL1014 RX	64	68	82	44	20°		6W					V	
AL1014 RDX	64	68	82	44	20°		9W			V			
ALIS 1014 RDX	46	68	82	65	30°		6W			V			V
LARY RD	66	68	82	65			9W	V		V			V
LARY SD	66	68	82x82	65			9W	V		V			V
IPHO 82 RD	67	68	83	65			9W	V		V			V
IPHO 82 SD	67	68	83x83	65			9W	V		V			V
SWEET RD EVO	70	68	76	54		2700-3000-4000K	7,5W	V		V		V	
COPE RD	68	68	80	65			7W	V		V			V
EPI RD	68	68	85	65			7W	V		V			V
SILK RDX	72	68	76	44	30°		6W	V		V		V	
SILK RDX WARM	73	68	76	44	30°	DIM TO WARM	6W	V		V		V	
ABY 1 RD	76	68	75	23			6,5W			V			
MARY RDX-230	46	75	90	23	30°		7,5W		V	V		V	
AL3012 RD	74	75	82	44			9W			V			
AL3012 RD WARM	74	75	82	44		DIM TO WARM	6W			V		V	
SYLA RD-B	75	75	82	23			10W			V	V		
ABY 2 RD	76	80	85	23			9W			V			
ABY 3 RD	77	92	98	23			15W			V			
DOTS	80	93x35	102x44	20			6W	V		V			
AL1015 RX	65	95	110	23	20°		12W	V					
ALLY 3 RDX	78	105	110	20	45°		10W	V		V			
ALLY 4 RDX	78	128	135	20	45°		14W	V		V			
AL2014 SDX	65	155x78	170x90	23	20°		2x9W			V			
DOTS	80	173x35	182x44	20			12W	V		V			
DOTS	80	253x35	262x44	20			16W	V		V			
DOTS	80	333x35	342x44	20			20W	V		V			

CLASSEMENT PAR DIAMÈTRES D'ENCASTREMENT



SEMI-ENCASTRÉS	PAGE 2025	 (mm)	DIMENSIONS (mm)	IP X	 X°	Watt Max	CCT	LED	UGR <19	 DIM	LAMELLES
JOY RX	97	35	39	20	90°			4,5W	V		
OKTO RX GU10	87	44	57	20	85°	10W					
EDDY RX	96	52	60	20	90°			2W	V		
FILI 5 RX-B GU10 AUTO	86	58	68	20	90°	10W					V
FILI 5 RDX-B	98	58	67	20	90°			14W		V	V
CLARA 1 RDX	88	65	70	20	90°			3W	V	V	
SIRA R	84	65-180	225	44			3000-4000-6000K	18W			
SIRA R SENSOR IR	84	65-180	225	20			3000-4000-6000K	12W-15W-18W			
CLIC RDX MINI	92	68	78	20	90°			8W	V	V	
ALLY 1 RX	90	70	75	20	90°			9W	V		
ALLY 1 RDX	90	70	75	20	90°			10W	V	V	
ALLY 2 RX	91	80	93	20	90°			13W	V		
ALLY 2 RDX	91	80	93	20	90°			14W	V	V	
DEAN RDX PLUS	99	80	94	20	90°		2700-3000-4000K	28W	V	V	
KARL 1 RDX	100	90	100	20	90°		3000-3500-4000K	13W	V	V	
CLIC RDX	92	94	100	20	90°			13W	V	V	
RETI 2 RX	94	95	105	20	90°			18W			
FILI 1 RX GU10 AUTO	86	102	112	20	45°	10W					
RETI 1 RX	94	115	125	20	90°			18W			
KARL 2 RDX	100	120	130	20	90°		3000-3500-4000K	26W	V	V	
FILI 1 RX-B	98	125	136	20	45°			10W			V
CLARA 2 RDX	88	130x65	135x70	20	90°			2x3W	V	V	

DOWNLIGHTS	PAGE 2025	 (mm)	DIMENSIONS (mm)	IP X	 X°	CCT	LED	UGR <19	LED 230V	 DIM	 RE 2020
DAX RD-230	104	68	85	65		2700-3000-4000-6000K	6W		V	V	V
SENSO R-230	104	90	115	44		2700-3000-4000K	9W		V		
LYON 1 R	115	95	110	44			15W	V		En option	
THEA LITE CSP 1	108	100	120	54		3000-4000-6000K	10W			En option	
LYON 2 R	116	125	135	44			25W	V		En option	
AL1016 RX	112	140	158	23	20°		26W	V			
THEA PRO 1	113	145-180	195	65			14W			En option	
THEA LITE CSP 2	109	150	170	54		3000-4000-6500K	14W			En option	
LYON 3 R	117	150	160	44			30W	V		En option	
TIGA 1 RD	106	155	170	44		3000-4000-6000K	12W			V	
IZA 1 SDX	120	162x162	176x176	20	30°	3000-4000K	24W			V	
THEA PRO 2	114	165-200	220	65			25W			En option	
LYON 4 R	118	175	186	44			40W	V		En option	
SPIRA 1 RX PLUS	122	175	186	23	80°	2700-3000-4000K	40W				
THEA LITE CSP 3	110	200	220	54		3000-4000-6500K	20W			En option	
TIGA 2 RD	106	205	220	44		3000-4000-6000K	18W			V	
FOX 2 RD	111	210	240	23			19W			V	V
SPIRA 3 RX	123	215	235	23	80°		60W				
TIGA 3 RD	107	225	240	44		3000-4000-6000K	24W			V	
FOCEA 1 SX PLUS	124	225x135	240x150	23	80°	2700-3000-4000K	40W				
FOCEA 2 SX	124	225x135	240x150	23	80°		60W				
IZA 2 SDX	120	300x162	320x176	20	30°	3000-4000K	2x24W			V	

INDIGO

LIGHTING



COLLERETTES



KASA R GU10

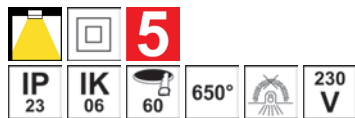

- Spot encastré rond fixe.
- Fixation par ressorts.
- Double bornier automatique.

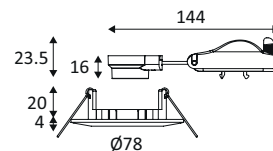

KASA R GU10	COULEUR	MATIÈRE	SOQUET	LAMPE	WATT MAX	€
DO54605	■ NOIR MAT	ALUMINIUM	GU10	PAR16 LED	10W	6,00
DO54621	■ NICKEL SATINÉ	ALUMINIUM	GU10	PAR16 LED	10W	7,00
DO54630	■ BLANC MAT	ALUMINIUM	GU10	PAR16 LED	10W	6,00

CONVERTISSEURS ET SOURCES		LED	€
LED9W500DWW	MODU LED 9W 940Lm 3000K 38°		9W 49,00



NOIR MAT



NICKEL SATINÉ



BLANC MAT

KASA RX GU10



- Spot encastré rond orientable.
- Fixation par ressorts.
- Double bornier automatique.

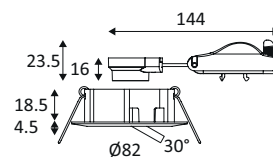

KASA RX GU10	COULEUR	MATIÈRE	SOQUET	LAMPE	WATT MAX	€
DO54705	■ NOIR MAT	ALUMINIUM	GU10	PAR16 LED	10W	7,00
DO54721	■ NICKEL SATINÉ	ALUMINIUM	GU10	PAR16 LED	10W	9,00
DO54730	■ BLANC MAT	ALUMINIUM	GU10	PAR16 LED	10W	7,00

CONVERTISSEURS ET SOURCES		LED	€
LED9W500DWW	MODU LED 9W 940Lm 3000K 38°		9W 49,00



NOIR MAT



NICKEL SATINÉ



BLANC MAT



KASA R GU10



ALA1013 RX GU10 AUTO



- Spot encastré rond orientable.
- Livré avec ressorts et lamelles.
- Double bornier automatique.
- Bague couvrant un diamètre de perçage de 90 à 120mm à commander séparément.

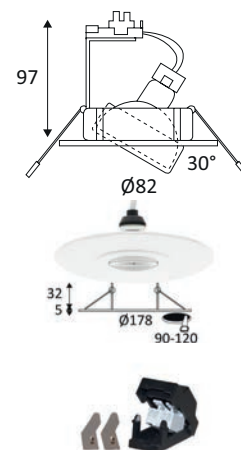

ALA1013 RX GU10 AUTO	COULEUR	MATIÈRE	SOQUET	LAMPE	WATT MAX	€
DO47505	■ NOIR MAT	ALUMINIUM	GU10	PAR16 LED	10W	15,00
ALA101325	■ ALUMINIUM MAT	ALUMINIUM	GU10	PAR16 LED	10W	15,00
ALA101330	■ BLANC MAT	ALUMINIUM	GU10	PAR16 LED	10W	15,00

ACCESSOIRES	COULEUR	MATIÈRE	DESCRIPTION	€
DO33330	BLANC MAT	ALUMINIUM	BAGUE DE MONTAGE 178MM	18,00
DO33305	NOIR MAT	ALUMINIUM	BAGUE DE MONTAGE 178MM	17,00

CONVERTISSEURS ET SOURCES			LED	€
LED9W500DWW	MODU LED 9W 940Lm 3000K 38°		9W	49,00



NOIR MAT



ALUMINIUM MAT



BLANC MAT



- Spot encastré orientable avec soquet GU10.
- Livré avec ressorts et lamelles pour encastrement en faux-plafond ou plafond béton.
- Connexion et repiquage aisés grâce au double bornier automatique.
- Bague couvrant un diamètre de perçage de 90 à 120mm disponible séparément.



ALA1013 SX GU10 AUTO



- Spot encastré carré orientable.
- Fixation par ressorts.
- Double bornier automatique.

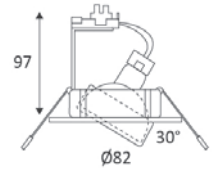

ALA1013 SX GU10 AUTO	COULEUR	MATIÈRE	L(MM)	SOQUET	LAMPE	WATT MAX	€
DO47605	■ NOIR MAT	ALUMINIUM	82	GU10	PAR16 LED	10W	24,00
ALA1013S25	■ ALUMINIUM MAT	ALUMINIUM	82	GU10	PAR16 LED	10W	24,00
ALA1013S30	■ BLANC MAT	ALUMINIUM	82	GU10	PAR16 LED	10W	24,00
CONVERTISSEURS ET SOURCES			LED	€			
LED9W500DWW	MODU LED 9W 940Lm 3000K 38°		9W	49,00			



NOIR MAT



ALUMINIUM MAT



BLANC MAT



BALI R GU10

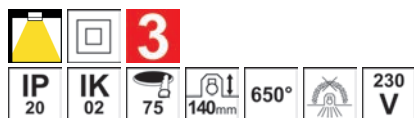

- Spot encastré rond fixe.
- Réflecteur basse luminosité.
- Fixation par ressorts.

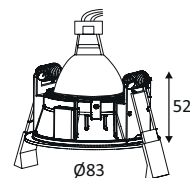

BALI R GU10	COULEUR	MATIÈRE	SOQUET	LAMPE	WATT MAX	€
DO51305	NOIR MAT	ALUMINIUM	GU10	PAR16 LED	10W	23,00
DO51308	NOIR MAT - CHAMPAGNE	ALUMINIUM	GU10	PAR16 LED	10W	26,00
DO51317	NOIR MAT - ARGENT	ALUMINIUM	GU10	PAR16 LED	10W	26,00
DO51330	BLANC MAT	ALUMINIUM	GU10	PAR16 LED	10W	23,00
DO51349	BLANC MAT - CHAMPAGNE	ALUMINIUM	GU10	PAR16 LED	10W	26,00
DO51353	BLANC MAT - ARGENT	ALUMINIUM	GU10	PAR16 LED	10W	26,00



NOIR MAT

NOIR MAT -
CHAMPAGNE

NOIR MAT - ARGENT



BLANC MAT

BLANC MAT -
CHAMPAGNEBLANC MAT -
ARGENT

FIJI R GU10



- Spot encastré rond fixe.
- Réflecteur basse luminosité.
- Fixation par ressorts.

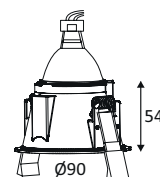

FIJI R GU10	COULEUR	MATIÈRE	SOQUET	LAMPE	WATT MAX	€
DO51405	NOIR MAT	ALUMINIUM	GU10	PAR16 LED	10W	22,00
DO51408	NOIR MAT - CHAMPAGNE	ALUMINIUM	GU10	PAR16 LED	10W	28,00
DO51417	NOIR MAT - ARGENT	ALUMINIUM	GU10	PAR16 LED	10W	28,00
DO51430	BLANC MAT	ALUMINIUM	GU10	PAR16 LED	10W	22,00
DO51449	BLANC MAT - CHAMPAGNE	ALUMINIUM	GU10	PAR16 LED	10W	28,00
DO51453	BLANC MAT - ARGENT	ALUMINIUM	GU10	PAR16 LED	10W	28,00



NOIR MAT

NOIR MAT -
CHAMPAGNE

NOIR MAT - ARGENT



BLANC MAT

BLANC MAT -
CHAMPAGNEBLANC MAT -
ARGENT



COMO RX GU10

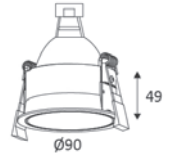

- Spot encastré rond orientable.
- Réflecteur basse luminance.
- Fixation par ressorts.

COMO RX GU10	COULEUR	MATIÈRE	SOQUET	LAMPE	WATT MAX	€
DO51805	■ NOIR MAT	ALUMINIUM	GU10	PAR16 LED	10W	25,00
DO51808	■ NOIR MAT - CHAMPAGNE	ALUMINIUM	GU10	PAR16 LED	10W	31,00
DO51817	■ NOIR MAT - ARGENT	ALUMINIUM	GU10	PAR16 LED	10W	31,00
DO51830	■ BLANC MAT	ALUMINIUM	GU10	PAR16 LED	10W	25,00
DO51849	■ BLANC MAT - CHAMPAGNE	ALUMINIUM	GU10	PAR16 LED	10W	31,00
DO51853	■ BLANC MAT - ARGENT	ALUMINIUM	GU10	PAR16 LED	10W	31,00



NOIR MAT

NOIR MAT -
CHAMPAGNE

NOIR MAT - ARGENT



BLANC MAT

BLANC MAT -
CHAMPAGNEBLANC MAT -
ARGENT

HD1050 R GU10



- Spot encastré rond fixe.
- Verre de protection sablé.
- Fixation par ressorts.

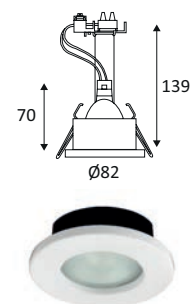

HD1050 R GU10	COULEUR	MATIÈRE	SOQUET	LAMPE	WATT MAX	€
HD105004	BLANC	ALUMINIUM	GU10	PAR16 LED	10W	17,00
HD105021	NICKEL SATINÉ	ALUMINIUM	GU10	PAR16 LED	10W	18,00



BLANC

NICKEL SATINÉ

HD1070 R GU5.3



- Spot encastré rond fixe.
- Verre de protection sablé.
- Fixation par ressorts.
- Transformateur à commander séparément.

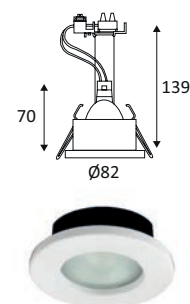

HD1070 R GU5.3	COULEUR	MATIÈRE	SOQUET	LAMPE	WATT MAX	€
HD107004	BLANC	ALUMINIUM	GU5.3	MR16 LED	10W	17,00
HD107021	NICKEL SATINÉ	ALUMINIUM	GU5.3	MR16 LED	10W	18,00



BLANC

NICKEL SATINÉ

HD1050 R GU10



HD1070 R GU5.3



IPHO R GU10 AUTO



- Spot encastré rond fixe.
- Fixation par ressorts.
- Double bornier automatique.

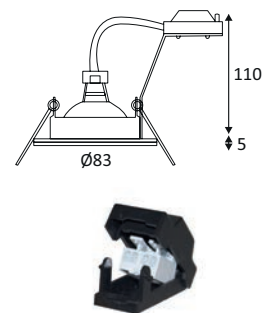

IPHO R GU10 AUTO	COULEUR	MATIÈRE	SOQUET	LAMPE	WATT MAX	€
DO19705	NOIR	VERRE	GU10	PAR16 LED	10W	32,00
DO19730	BLANC	VERRE	GU10	PAR16 LED	10W	32,00

DANS LA MÊME GAMME



NOIR

BLANC

IPHO 82 RD VERSION LED
INTÉGRÉE PAGE 67

IPHO S GU10 AUTO



- Spot encastré carré fixe.
- Fixation par ressorts.
- Double bornier automatique.

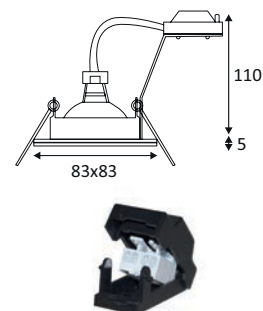

IPHO S GU10 AUTO	COULEUR	MATIÈRE	L(MM)	SOQUET	LAMPE	WATT MAX	€
DO21205	NOIR	VERRE	83	GU10	PAR16 LED	10W	34,00
DO21230	BLANC	VERRE	83	GU10	PAR16 LED	10W	34,00

DANS LA MÊME GAMME



NOIR

BLANC

IPHO 82 SD VERSION LED
INTÉGRÉE PAGE 67

I PHO S GU10 AUTO



INDIGO

LIGHTING



SPOTS

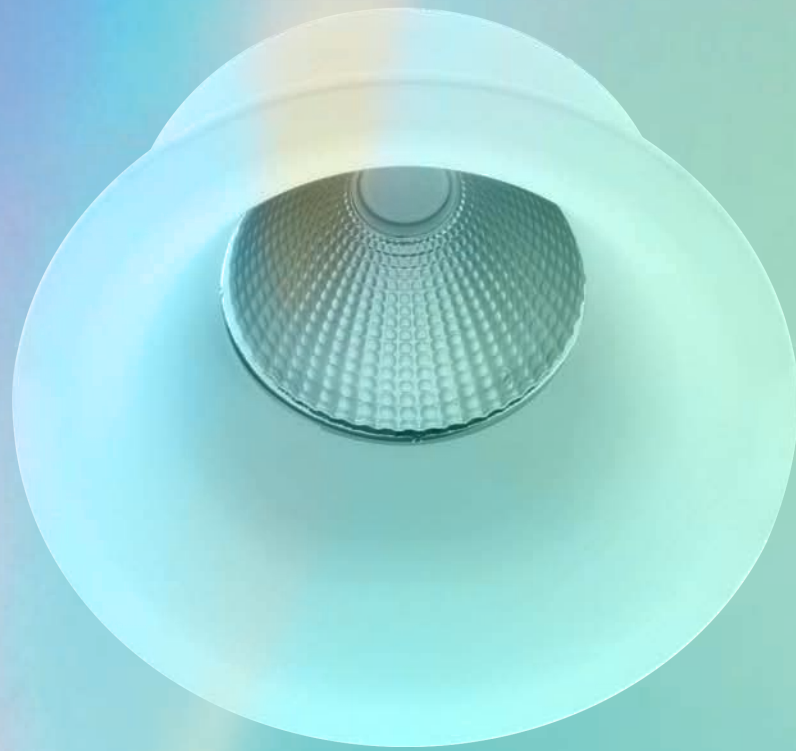

LASY RX



- Spot encastré rond orientable.
- Fixation par ressorts.
- Peut être recouvert par un isolant déroulé.
- Double bornier automatique.
- Convertisseur non dimmable déporté fourni.

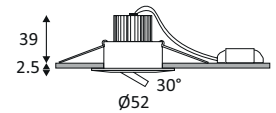

LASY RX	COULEUR	MATIÈRE	P	T°	LED LUMEN	SYSTEM LUMEN	α	€
DO334WW05	NOIR MAT	FONTE D'ALUMINIUM	1W	3000K	130Lm	110Lm	24°	43,00
DO334WW25	ALUMINIUM SATINÉ	FONTE D'ALUMINIUM	1W	3000K	130Lm	110Lm	24°	43,00
DO334WW30	BLANC MAT	FONTE D'ALUMINIUM	1W	3000K	130Lm	110Lm	24°	43,00



NOIR MAT

ALUMINIUM SATINÉ

BLANC MAT

TIBLI R-B

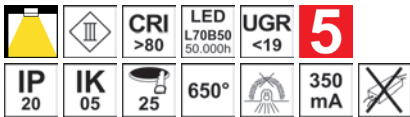

- Spot encastré rond fixe.
- Fixation par lamelles.
- Connecteur rapide et 2.00m de câble inclus.
- Convertisseur dimmable 350mA (montage déporté du convertisseur) à commander séparément (CD167 min. 2, max. 3 TIBLI R-B, compatible avec variateur début et fin de phase).

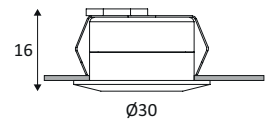

TIBLI R-B	COULEUR	MATIÈRE	P	T°	LED LUMEN	SYSTEM LUMEN	α	€
DO468WW05	NOIR MAT	ALUMINIUM	1,2W	3000K	115Lm	105Lm	20°	32,00
DO468WW30	BLANC MAT	ALUMINIUM	1,2W	3000K	115Lm	105Lm	20°	32,00

CONVERTISSEURS ET SOURCES	WATT MAX	€
CD167	DRIVER 2-4W 350MA CC DIM	25,00



NOIR MAT

BLANC MAT



SPOTI R-B

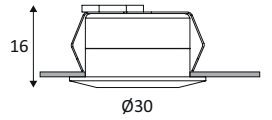
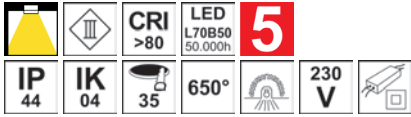

- Spot encastré rond fixe.
- Fixation par lamelles.
- Précâblé 1.50m.
- Peut être recouvert par un isolant déroulé.
- Double bornier automatique.
- Convertisseur non dimmable déporté fourni, peut être placé à max. 10m de l'appareil.



SPOTI R-B	COULEUR	MATIÈRE	P	T°	LED LUMEN	SYSTEM LUMEN	α	€
DO241SW25	ALUMINIUM	FONTE D'ALUMINIUM	4,5W	2700K	480Lm	415Lm	24°	59,00
DO241SW30	BLANC MAT	FONTE D'ALUMINIUM	6W	2700K	590Lm	560Lm	24°	59,00
DO241SW38	ANTHRACITE ANODISÉ	FONTE D'ALUMINIUM	4,5W	2700K	480Lm	340Lm	24°	59,00
DO241WW25	ALUMINIUM	FONTE D'ALUMINIUM	6W	3000K	620Lm	595Lm	24°	59,00
DO241WW30	BLANC MAT	FONTE D'ALUMINIUM	6W	3000K	620Lm	595Lm	24°	59,00
DO241WW38	ANTHRACITE ANODISÉ	FONTE D'ALUMINIUM	6W	3000K	620Lm	570Lm	24°	59,00
DO241NW25	ALUMINIUM	FONTE D'ALUMINIUM	4,5W	4000K	490Lm	450Lm	24°	59,00
DO241NW30	BLANC MAT	FONTE D'ALUMINIUM	6W	4000K	640Lm	605Lm	24°	59,00
DO241NW38	ANTHRACITE ANODISÉ	FONTE D'ALUMINIUM	6W	4000K	640Lm	575Lm	24°	59,00



ALUMINIUM



BLANC MAT

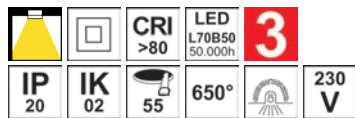

ANTHRACITE
ANODISÉ

KALI R-230 B

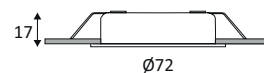

- Spot encastré rond.
- Diffuseur en verre opalin.
- Fixation par lamelles.
- Peut être recouvert par un isolant déroulé.
- Double bornier automatique.
- Ne nécessite pas de convertisseur.
- Non dimmable.
- Accessoire pour pose apparente à commander séparément.



KALI R-230 B	COULEUR	MATIÈRE	P	T°	LED LUMEN	SYSTEM LUMEN	α	€	
DO337WW05	■ NOIR MAT	ALUMINIUM	4,7W	3000K	410Lm	290Lm	100°	57,00	
DO337WW21	■ NICKEL SATINÉ	ALUMINIUM	4,7W	3000K	410Lm	290Lm	100°	59,00	
DO337WW30	■ BLANC MAT	ALUMINIUM	4,7W	3000K	410Lm	290Lm	100°	57,00	
ACCESSOIRES	COULEUR	MATIÈRE	DESCRIPTION					€	
DO33805	■ NOIR MAT	ALUMINIUM	BASE RONDE					 ↕20	27,00
DO33821	■ NICKEL SATINÉ	ALUMINIUM	BASE RONDE					 ↕20	27,00
DO33830	■ BLANC MAT	ALUMINIUM	BASE RONDE					 ↕20	27,00



NOIR MAT



NICKEL SATINÉ



BLANC MAT





KACI R-B

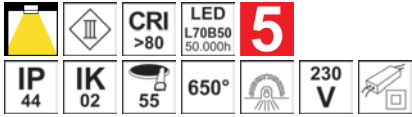

- Spot encastré rond.
- Diffuseur en verre dépoli.
- Fixation par lamelles.
- Précâblé 0.50m.
- Peut être recouvert par un isolant déroulé.
- Double bornier automatique.
- Convertisseur non dimmable déporté fourni, peut être placé à max. 10m de l'appareil.

KACI R-B	COULEUR	MATIÈRE	P	T°	LED LUMEN	SYSTEM LUMEN	α	€
KC211R25	ALUMINIUM BROSSÉ	ALUMINIUM	3W	3000K	450Lm	335Lm	100°	57,00
KC211R30	BLANC MAT	ALUMINIUM	3W	3000K	450Lm	335Lm	100°	57,00

ALUMINIUM
BROSSÉ

BLANC MAT



LISY RD

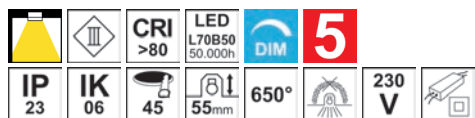

- Spot encastré rond fixe.
- Réflecteur basse luminance.
- Fixation par ressorts.
- Convertisseur dimmable déporté fourni.
- Compatible avec variateur début et fin de phase.

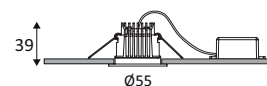

LISY RD	COULEUR	MATIÈRE	P	T°	LED LUMEN	SYSTEM LUMEN	α	€
DO459WW05	■ NOIR MAT	FONTE D'ALUMINIUM	4,5W	3000K	600Lm	440Lm	36°	60,00
DO459WW30	■ BLANC MAT	FONTE D'ALUMINIUM	4,5W	3000K	600Lm	440Lm	36°	60,00



NOIR MAT



BLANC MAT

LISY RDX

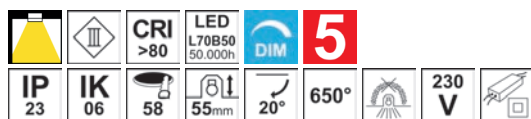

- Spot encastré rond orientable.
- Réflecteur basse luminance.
- Fixation par ressorts.
- Convertisseur dimmable déporté fourni.
- Compatible avec variateur début et fin de phase.

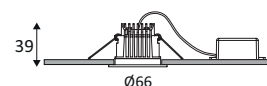

LISY RDX	COULEUR	MATIÈRE	P	T°	LED LUMEN	SYSTEM LUMEN	α	€
DO460WW05	■ NOIR MAT	FONTE D'ALUMINIUM	4,5W	3000K	600Lm	475Lm	36°	60,00
DO460WW30	■ BLANC MAT	FONTE D'ALUMINIUM	4,5W	3000K	600Lm	475Lm	36°	60,00



NOIR MAT



BLANC MAT



MOWI RD

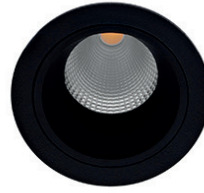
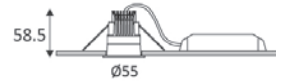

- Spot encastré rond fixe.
- Réflecteur basse luminance.
- Fixation par ressorts.
- Convertisseur dimmable déporté fourni.
- Compatible avec variateur début et fin de phase.

MOWI RD	COULEUR	MATIÈRE	P	T°	LED LUMEN	SYSTEM LUMEN	α	€
DO467WW05	■ NOIR MAT	FONTE D'ALUMINIUM	6W	3000K	550Lm	295Lm	36°	68,00
DO467WW30	■ BLANC MAT	FONTE D'ALUMINIUM	6W	3000K	550Lm	295Lm	36°	68,00



NOIR MAT



BLANC MAT



TIPI RX



- Spot encastré rond orientable.
- Fixation par ressorts.
- Peut être recouvert par un isolant déroulé.
- Double bornier automatique.
- Convertisseur non dimmable déporté fourni, peut être placé à max. 10m de l'appareil.

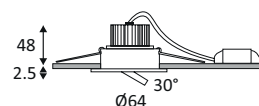

TIPI RX	COULEUR	MATIÈRE	P	T°	LED LUMEN	SYSTEM LUMEN	α	€
DO104WW05	■ NOIR MAT	FONTE D'ALUMINIUM	3W	3000K	350Lm	300Lm	30°	57,00
DO104WW25	■ ALUMINIUM	FONTE D'ALUMINIUM	3W	3000K	350Lm	300Lm	30°	57,00
DO104WW30	■ BLANC MAT	FONTE D'ALUMINIUM	3W	3000K	350Lm	300Lm	30°	57,00



NOIR MAT



ALUMINIUM



BLANC MAT

TIPI SX



- Spot encastré carré orientable.
- Fixation par ressorts.
- Peut être recouvert par un isolant déroulé.
- Double bornier automatique.
- Convertisseur non dimmable déporté fourni, peut être placé à max. 10m de l'appareil.

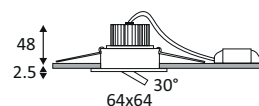

TIPI SX	COULEUR	MATIÈRE	P	T°	L(MM)	LED LUMEN	SYSTEM LUMEN	α	€
DO103WW05	■ NOIR MAT	FONTE D'ALUMINIUM	3W	3000K	64	350Lm	300Lm	30°	61,00
DO103WW25	■ ALUMINIUM	FONTE D'ALUMINIUM	3W	3000K	64	350Lm	300Lm	30°	61,00
DO103WW30	■ BLANC MAT	FONTE D'ALUMINIUM	3W	3000K	64	350Lm	300Lm	30°	61,00



NOIR MAT



ALUMINIUM



BLANC MAT

TIPI RX



BRAVA RD-230



- Spot encastré rond fixe 3 en 1.
- 2700K, 3000K ou 4000K au choix via un interrupteur à l'arrière du luminaire.
- Fixation par ressorts.
- Peut être recouvert par un isolant déroulé ou soufflé.
- Double bornier automatique.
- Ne nécessite pas de convertisseur.
- Dimmable.
- Compatible avec variateur fin de phase.

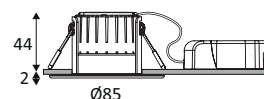

BRAVA RD-230	COULEUR	MATIÈRE	P	T°	LED LUMEN	SYSTEM LUMEN	α	€
DO54405	■ NOIR MAT	ALUMINIUM + COMPOSITE	5W	2700K 3000K 4000K	680Lm (4000K)	615Lm (4000K)	60°	25,00
DO54430	■ BLANC MAT	ALUMINIUM + COMPOSITE	5W	2700K 3000K 4000K	680Lm (4000K)	615Lm (4000K)	60°	25,00



NOIR MAT



BLANC MAT

BRAVA RDH-230



- Spot encastré rond fixe 3 en 1.
- 2700K, 3000K ou 4000K au choix via un interrupteur à l'arrière du luminaire.
- Réflecteur basse luminance.
- Fixation par ressorts.
- Peut être recouvert par un isolant déroulé ou soufflé.
- Double bornier automatique.
- Ne nécessite pas de convertisseur.
- Dimmable.
- Compatible avec variateur fin de phase.

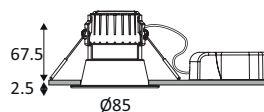

BRAVA RDH-230	COULEUR	MATIÈRE	P	T°	LED LUMEN	SYSTEM LUMEN	α	€
DO54505	■ NOIR MAT	ALUMINIUM + COMPOSITE	5W	2700K 3000K 4000K	680Lm (4000K)	400Lm (4000K)	60°	29,00
DO54530	■ BLANC MAT	ALUMINIUM + COMPOSITE	5W	2700K 3000K 4000K	680Lm (4000K)	555Lm (4000K)	60°	29,00



NOIR MAT



BLANC MAT



BRAVA RDH-230



MARY RDX-230

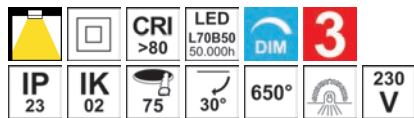

- Spot encastré rond orientable.
- Fixation par ressorts.
- Peut être recouvert par un isolant déroulé.
- Double bornier automatique.
- Ne nécessite pas de convertisseur.
- Dimmable.
- Compatible avec variateur fin de phase.

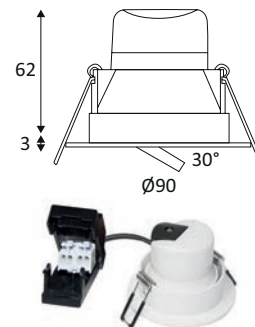

MARY RDX-230	COULEUR	MATIÈRE	P	T°	LED LUMEN	SYSTEM LUMEN	α	€
DO315WW05	■ NOIR MAT	COMPOSITE	7,5W	3000K	750Lm	600Lm	60°	34,00
DO315WW30	■ BLANC MAT	COMPOSITE	7,5W	3000K	750Lm	600Lm	60°	34,00
DO315NW05	■ NOIR MAT	COMPOSITE	7,5W	4000K	770Lm	615Lm	60°	34,00
DO315NW30	■ BLANC MAT	COMPOSITE	7,5W	4000K	770Lm	615Lm	60°	34,00



NOIR MAT



BLANC MAT

ALIS 1014 RDX

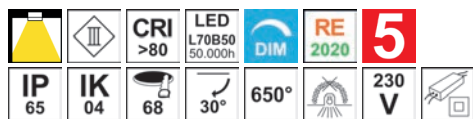

- Spot encastré rond orientable.
- Fixation par ressorts.
- Double bornier automatique.
- Avec membrane pour préserver l'étanchéité.
- Convertisseur dimmable déporté fourni.
- Compatible avec variateur début et fin de phase.

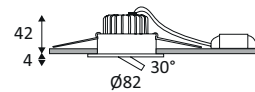

ALIS 1014 RDX	COULEUR	MATIÈRE	P	T°	LED LUMEN	SYSTEM LUMEN	α	€
DO227WW05	■ NOIR MAT	FONTE D'ALUMINIUM	6W	3000K	740Lm	675Lm	38°	71,00
DO227WW25	■ ALUMINIUM	FONTE D'ALUMINIUM	6W	3000K	740Lm	675Lm	38°	97,00
DO227WW30	■ BLANC MAT	FONTE D'ALUMINIUM	6W	3000K	740Lm	675Lm	38°	71,00
DO227NW05	■ NOIR MAT	FONTE D'ALUMINIUM	6W	4000K	800Lm	730Lm	38°	71,00
DO227NW25	■ ALUMINIUM	FONTE D'ALUMINIUM	6W	4000K	800Lm	730Lm	38°	97,00
DO227NW30	■ BLANC MAT	FONTE D'ALUMINIUM	6W	4000K	800Lm	730Lm	38°	71,00



NOIR MAT



ALUMINIUM



BLANC MAT



ALIS 1014 RDX



DEBI RD-230

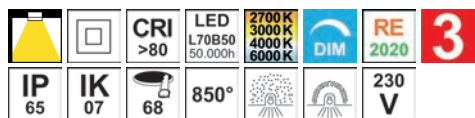

- Spot encastré rond fixe 4 en 1.
- 2700K, 3000K, 4000K ou 6000K au choix via un interrupteur à l'arrière du luminaire.
- Fixation par ressorts.
- Peut être recouvert par un isolant déroulé ou soufflé.
- Double bornier automatique.
- Ne nécessite pas de convertisseur.
- Dimmable.
- Compatible avec variateur fin de phase.

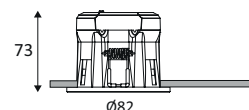

DEBI RD-230	COULEUR	MATIÈRE	P	T°	LED LUMEN	SYSTEM LUMEN	α	€
DO44505	■ NOIR MAT	ALUMINIUM + COMPOSITE	5W	2700K 3000K 4000K 6000K	620Lm (4000K)	505Lm (4000K)	60°	28,00
DO44530	■ BLANC MAT	ALUMINIUM + COMPOSITE	5W	2700K 3000K 4000K 6000K	620Lm (4000K)	505Lm (4000K)	60°	28,00



NOIR MAT



BLANC MAT

DEBI RD



- Spot encastré rond fixe 4 en 1.
- 2700K, 3000K, 4000K ou 6000K au choix via un interrupteur à l'arrière du luminaire.
- Fixation par ressorts.
- Peut être recouvert par un isolant déroulé ou soufflé, convertisseur compris.
- Double bornier automatique.
- Convertisseur dimmable déporté fourni.
- Compatible avec variateur fin de phase.

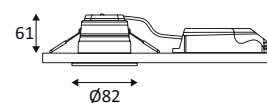

DEBI RD	COULEUR	MATIÈRE	P	T°	LED LUMEN	SYSTEM LUMEN	α	€
DO43005	■ NOIR MAT	ALUMINIUM + COMPOSITE	6W	2700K 3000K 4000K 6000K	720Lm (4000K)	565Lm (4000K)	60°	34,00
DO43030	■ BLANC MAT	ALUMINIUM + COMPOSITE	6W	2700K 3000K 4000K 6000K	720Lm (4000K)	565Lm (4000K)	60°	34,00



NOIR MAT



BLANC MAT

DEBI RD



IENA RDX-230

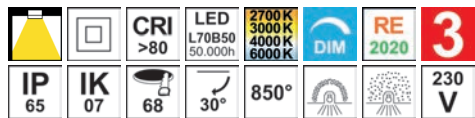

- Spot encastré rond orientable 4 en 1.
- 2700K, 3000K, 4000K ou 6000K au choix via un interrupteur à l'arrière du luminaire.
- Fixation par ressorts.
- Peut être recouvert par un isolant déroulé ou soufflé.
- Double bornier automatique.
- Ne nécessite pas de convertisseur.
- Dimmable.
- Compatible avec variateur fin de phase.

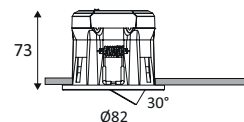

IENA RDX-230	COULEUR	MATIÈRE	P	T°	LED LUMEN	SYSTEM LUMEN	α	€
DO44605	NOIR MAT	ALUMINIUM + COMPOSITE	5W	2700K 3000K 4000K 6000K	620Lm (4000K)	505Lm (4000K)	60°	32,00
DO44630	BLANC MAT	ALUMINIUM + COMPOSITE	5W	2700K 3000K 4000K 6000K	620Lm (4000K)	505Lm (4000K)	60°	32,00



NOIR MAT

BLANC MAT

IENA RDX

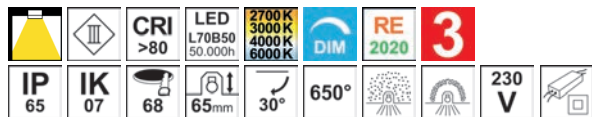

- Spot encastré rond orientable 4 en 1.
- 2700K, 3000K, 4000K ou 6000K au choix via un interrupteur à l'arrière du luminaire.
- Fixation par ressorts.
- Peut être recouvert par un isolant déroulé ou soufflé, convertisseur compris.
- Double bornier automatique.
- Convertisseur dimmable déporté fourni.
- Compatible avec variateur fin de phase.

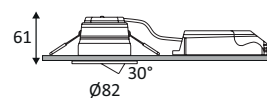

IENA RDX	COULEUR	MATIÈRE	P	T°	LED LUMEN	SYSTEM LUMEN	α	€
DO43105	NOIR MAT	ALUMINIUM + COMPOSITE	6W	2700K 3000K 4000K 6000K	720Lm (4000K)	565Lm (4000K)	60°	37,00
DO43130	BLANC MAT	ALUMINIUM + COMPOSITE	6W	2700K 3000K 4000K 6000K	720Lm (4000K)	565Lm (4000K)	60°	37,00



NOIR MAT

BLANC MAT



IENA RDX



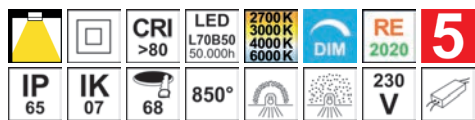

BORA RD-230 EVO

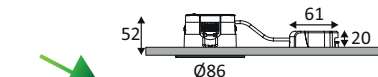

- Spot encastré rond fixe 4 en 1.
- 2700K, 3000K, 4000K ou 6000K au choix via un interrupteur à l'arrière du luminaire.
- Fixation par ressorts.
- Peut être recouvert par un isolant déroulé ou soufflé.
- Double bornier automatique.
- Convertisseur dimmable intégré dans l'appareil.
- Compatible avec variateur fin de phase.
- Convertisseur ou source de remplacement disponibles séparément.



BORA RD-230 EVO	COULEUR	MATIÈRE	P	T°	LED LUMEN	SYSTEM LUMEN	α	€
DO52005	NEW ■ NOIR MAT	ALUMINIUM + COMPOSITE	5W	2700K 3000K 4000K 6000K	615Lm (4000K)	545Lm (4000K)	60°	32,00
DO52021	NEW ■ NICKEL SATINÉ	ALUMINIUM + COMPOSITE	5W	2700K 3000K 4000K 6000K	615Lm (4000K)	545Lm (4000K)	60°	32,00
DO52030	NEW ■ BLANC MAT	ALUMINIUM + COMPOSITE	5W	2700K 3000K 4000K 6000K	615Lm (4000K)	545Lm (4000K)	60°	32,00

CONVERTISSEURS ET SOURCES			LED	WATT MAX	€
CD520	DRIVER 5W 180MA CC DIM	NEW 		5W	12,00
LP520	SOURCE LED 3,8W 615Lm 60°	NEW 	3,8W		7,00



NOIR MAT



NICKEL SATINÉ



BLANC MAT



NEW

BORA RDX-230 EVO

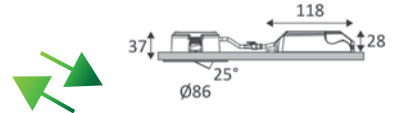
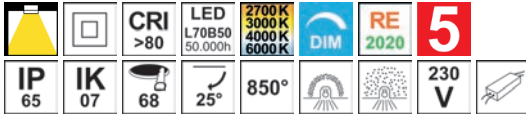

- Spot encastré rond orientable 4 en 1.
- 2700K, 3000K, 4000K ou 6000K au choix via un interrupteur à l'arrière du luminaire.
- Fixation par ressorts.
- Peut être recouvert par un isolant déroulé ou soufflé.
- Double bornier automatique.
- Convertisseur dimmable intégré dans l'appareil.
- Compatible avec variateur fin de phase.
- Convertisseur ou source de remplacement disponibles séparément.

BORA RDX-230 EVO	COULEUR	MATIÈRE	P	T°	LED LUMEN	SYSTEM LUMEN	α	€
DO52105	NEW NOIR MAT	ALUMINIUM + COMPOSITE	5W	2700K 3000K 4000K 6000K	615Lm (4000K)	545Lm (4000K)	60°	33,00
DO52121	NEW NICKEL SATINÉ	ALUMINIUM + COMPOSITE	5W	2700K 3000K 4000K 6000K	615Lm (4000K)	545Lm (4000K)	60°	33,00
DO52130	NEW BLANC MAT	ALUMINIUM + COMPOSITE	5W	2700K 3000K 4000K 6000K	615Lm (4000K)	545Lm (4000K)	60°	33,00

CONVERTISSEURS ET SOURCES			LED	WATT MAX	€
CD520	DRIVER 5W 180MA CC DIM	NEW		5W	12,00
LP520	SOURCE LED 3,8W 615Lm 60°	NEW	3,8W		7,00



NOIR MAT



NICKEL SATINÉ



BLANC MAT





BORA RD EVO

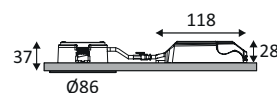

- Spot encastré rond fixe 4 en 1.
- 2700K, 3000K, 4000K ou 6000K au choix via un interrupteur sur le convertisseur.
- Fixation par ressorts.
- Peut être recouvert par un isolant déroulé ou soufflé, convertisseur compris.
- Double bornier automatique.
- Convertisseur dimmable déporté fourni.
- Compatible avec variateur fin de phase.
- Convertisseur ou source de remplacement disponibles séparément.



BORA RD EVO	COULEUR	MATIÈRE	P	T°	LED LUMEN	SYSTEM LUMEN	α	€
DO55105	NEW NOIR MAT	ALUMINIUM + COMPOSITE	7W	2700K 3000K 4000K 6000K	800Lm (4000K)	720Lm (4000K)	60°	39,00
DO55121	NEW NICKEL SATINÉ	ALUMINIUM + COMPOSITE	7W	2700K 3000K 4000K 6000K	800Lm (4000K)	720Lm (4000K)	60°	39,00
DO55130	NEW BLANC MAT	ALUMINIUM + COMPOSITE	7W	2700K 3000K 4000K 6000K	800Lm (4000K)	720Lm (4000K)	60°	39,00

CONVERTISSEURS ET SOURCES			LED	WATT MAX	€
CD553	DRIVER 7W 190MA CC DIM	NEW		7W	24,00
LP551	SOURCE LED 5,2W 800Lm 60°	NEW		5,2W	12,00



NOIR MAT



NICKEL SATINÉ



BLANC MAT



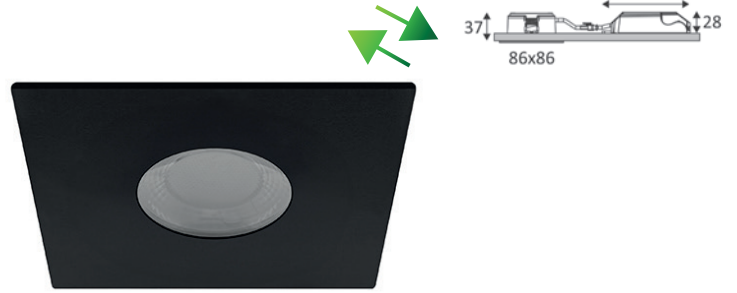
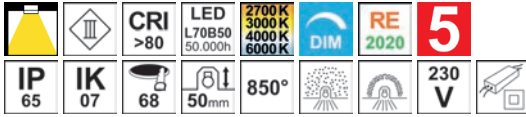

BORA SD EVO



- Spot encastré carré fixe 4 en 1.
- 2700K, 3000K, 4000K ou 6000K au choix via un interrupteur sur le convertisseur.
- Fixation par ressorts.
- Peut être recouvert par un isolant déroulé ou soufflé, convertisseur compris.
- Double bornier automatique.
- Convertisseur dimmable déporté fourni.
- Compatible avec variateur fin de phase.
- Convertisseur ou source de remplacement disponibles séparément.

BORA SD EVO	COULEUR	MATIÈRE	P	T°	L(MM)	LED LUMEN	SYSTEM LUMEN	α	€
DO55405	NEW NOIR MAT	ALUMINIUM + COMPOSITE	7W	2700K 3000K 4000K 6000K	86	800Lm (4000K)	720Lm (4000K)	60°	45,00
DO55421	NEW NICKEL SATINÉ	ALUMINIUM + COMPOSITE	7W	2700K 3000K 4000K 6000K	86	800Lm (4000K)	720Lm (4000K)	60°	45,00
DO55430	NEW BLANC MAT	ALUMINIUM + COMPOSITE	7W	2700K 3000K 4000K 6000K	86	800Lm (4000K)	720Lm (4000K)	60°	45,00

CONVERTISSEURS ET SOURCES			LED	WATT MAX	€
CD553	DRIVER 7W 190MA CC DIM	NEW		7W	24,00
LP551	SOURCE LED 5,2W 800Lm 60°	NEW		5,2W	12,00



NOIR MAT



NICKEL SATINÉ



BLANC MAT

BORA RDX EVO

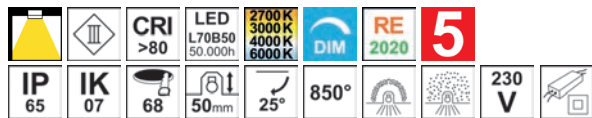

- Spot encastré rond orientable 4 en 1.
- 2700K, 3000K, 4000K ou 6000K au choix via un interrupteur sur le convertisseur.
- Fixation par ressorts.
- Peut être recouvert par un isolant déroulé ou soufflé, convertisseur compris.
- Double bornier automatique.
- Convertisseur dimmable déporté fourni.
- Compatible avec variateur fin de phase.
- Convertisseur ou source de remplacement disponibles séparément.

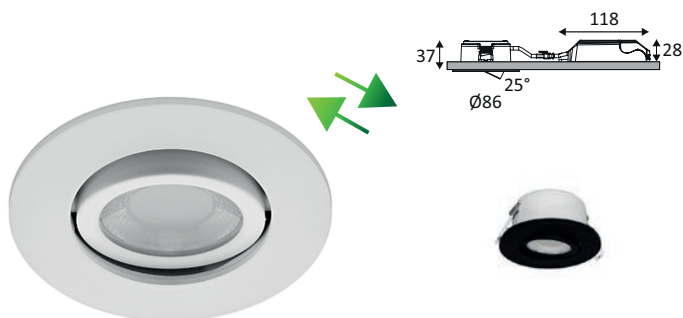

BORA RDX EVO	COULEUR	MATIÈRE	P	T°	LED LUMEN	SYSTEM LUMEN	α	€
DO55205	NEW NOIR MAT	ALUMINIUM + COMPOSITE	7W	2700K 3000K 4000K 6000K	800Lm (4000K)	720Lm (4000K)	60°	44,00
DO55221	NEW NICKEL SATINÉ	ALUMINIUM + COMPOSITE	7W	2700K 3000K 4000K 6000K	800Lm (4000K)	720Lm (4000K)	60°	44,00
DO55230	NEW BLANC MAT	ALUMINIUM + COMPOSITE	7W	2700K 3000K 4000K 6000K	800Lm (4000K)	720Lm (4000K)	60°	44,00

CONVERTISSEURS ET SOURCES			LED	WATT MAX	€
CD553	DRIVER 7W 190MA CC DIM	NEW		7W	24,00
LP551	SOURCE LED 5,2W 800Lm 60°	NEW		5,2W	12,00



NOIR MAT



NICKEL SATINÉ



BLANC MAT





BORA SDX EVO

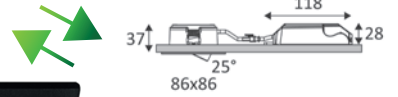
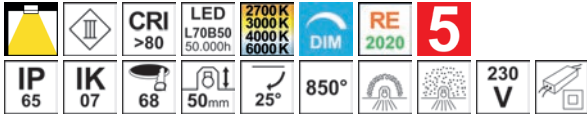

- Spot encastré carré orientable 4 en 1.
- 2700K, 3000K, 4000K ou 6000K au choix via un interrupteur sur le convertisseur.
- Fixation par ressorts.
- Peut être recouvert par un isolant déroulé ou soufflé, convertisseur compris.
- Double bornier automatique.
- Convertisseur dimmable déporté fourni.
- Compatible avec variateur fin de phase.
- Convertisseur ou source de remplacement disponibles séparément.

BORA SDX EVO	COULEUR	MATIÈRE	P	T°	L(MM)	LED LUMEN	SYSTEM LUMEN	α	€
DO55505	NEW NOIR MAT	ALUMINIUM + COMPOSITE	7W	2700K 3000K 4000K 6000K	86	800Lm (4000K)	720Lm (4000K)	60°	49,00
DO55521	NEW NICKEL SATINÉ	ALUMINIUM + COMPOSITE	7W	2700K 3000K 4000K 6000K	86	800Lm (4000K)	720Lm (4000K)	60°	49,00
DO55530	NEW BLANC MAT	ALUMINIUM + COMPOSITE	7W	2700K 3000K 4000K 6000K	86	800Lm (4000K)	720Lm (4000K)	60°	49,00

CONVERTISSEURS ET SOURCES			LED	WATT MAX	€
CD553	DRIVER 7W 190MA CC DIM	NEW		7W	24,00
LP551	SOURCE LED 5,2W 800Lm 60°	NEW		5,2W	12,00



NOIR MAT NICKEL SATINÉ BLANC MAT





BORA RDH EVO

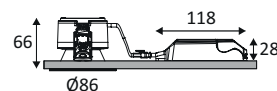

- Spot encastré rond fixe 4 en 1.
- 2700K, 3000K, 4000K ou 6000K au choix via un interrupteur sur le convertisseur.
- Réflecteur basse luminance.
- Fixation par ressorts.
- Peut être recouvert par un isolant déroulé ou soufflé, convertisseur compris.
- Double bornier automatique.
- Convertisseur dimmable déporté fourni.
- Compatible avec variateur fin de phase.
- Convertisseur ou source de remplacement disponibles séparément.



BORA RDH EVO	COULEUR	MATIÈRE	P	T°	LED LUMEN	SYSTEM LUMEN	α	€
DO55305	NEW NOIR MAT	ALUMINIUM + COMPOSITE	7W	2700K 3000K 4000K 6000K	800Lm (4000K)	565Lm (4000K)	60°	42,00
DO55344	NEW NOIR MAT - LAITON MAT	ALUMINIUM + COMPOSITE	7W	2700K 3000K 4000K 6000K	800Lm (4000K)	615Lm (4000K)	60°	49,00
DO55317	NEW NOIR MAT - ARGENT	ALUMINIUM + COMPOSITE	7W	2700K 3000K 4000K 6000K	800Lm (4000K)	645Lm (4000K)	60°	49,00
DO55330	NEW BLANC MAT	ALUMINIUM + COMPOSITE	7W	2700K 3000K 4000K 6000K	800Lm (4000K)	665Lm (4000K)	60°	42,00
DO55348	NEW BLANC MAT - LAITON MAT	ALUMINIUM + COMPOSITE	7W	2700K 3000K 4000K 6000K	800Lm (4000K)	640Lm (4000K)	60°	49,00
DO55353	NEW BLANC MAT - ARGENT	ALUMINIUM + COMPOSITE	7W	2700K 3000K 4000K 6000K	800Lm (4000K)	640Lm (4000K)	60°	49,00

CONVERTISSEURS ET SOURCES			LED	WATT MAX	€
CD553	DRIVER 7W 190MA CC DIM	NEW		7W	24,00
LP551	SOURCE LED 5,2W 800Lm 60°	NEW		5,2W	12,00



NOIR MAT



NOIR MAT - LAITON MAT



NOIR MAT - ARGENT



BLANC MAT



BLANC MAT - LAITON MAT



BLANC MAT - ARGENT

BORA RDH EVO



ALEX RDX

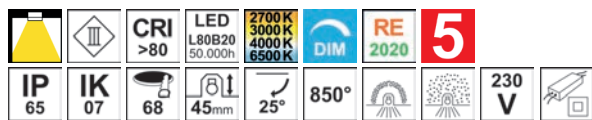

- Spot encastré rond orientable 4 en 1.
- 2700K, 3000K, 4000K ou 6500K au choix via un interrupteur sur le convertisseur.
- Fixation par ressorts.
- Peut être recouvert par un isolant déroulé ou soufflé, convertisseur compris.
- Double bornier automatique.
- Convertisseur dimmable déporté fourni.
- Compatible avec variateur début et fin de phase.
- Driver ou spot de remplacement disponibles séparément.

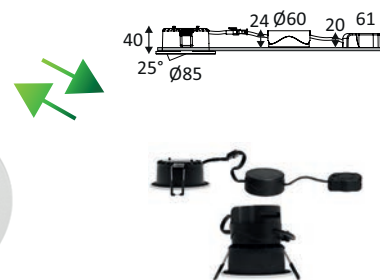

ALEX RDX	COULEUR	MATIÈRE	P	T°	LED LUMEN	SYSTEM LUMEN	α	€
DO53305	■ NOIR MAT	ALUMINIUM + COMPOSITE	6W	2700K 3000K 4000K 6500K	700Lm (4000K)	575Lm (4000K)	60°	43,00
DO53321	■ NICKEL SATINÉ	ALUMINIUM + COMPOSITE	6W	2700K 3000K 4000K 6500K	700Lm (4000K)	575Lm (4000K)	60°	46,00
DO53330	■ BLANC MAT	ALUMINIUM + COMPOSITE	6W	2700K 3000K 4000K 6500K	700Lm (4000K)	575Lm (4000K)	60°	42,00

CONVERTISSEURS ET SOURCES			WATT MAX	€
CD533	DRIVER 6W 260MA CC DIM		6W	21,00
LP53305	SPOT 6W 700Lm 60° IP65			17,00
LP53321	SPOT 6W 700Lm 60° IP65			20,00
LP53330	SPOT 6W 700Lm 60° IP65			16,00



NOIR MAT



NICKEL SATINÉ



BLANC MAT

ALEX RDX



KORY R



- Spot encastré rond fixe 3 en 1.
- 2700K, 3000K ou 4000K au choix via un interrupteur dans le luminaire.
- Fixation par ressorts.
- Peut être recouvert par un isolant déroulé ou soufflé, convertisseur compris.
- Double bornier automatique.
- Convertisseur non dimmable déporté fourni.

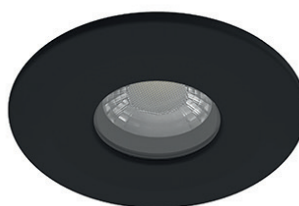
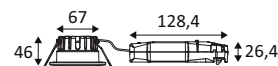

KORY R	COULEUR	MATIÈRE	P	T°	LED LUMEN	SYSTEM LUMEN	α	€
DO54905	■ NOIR MAT	ALUMINIUM + COMPOSITE	6W	2700K 3000K 4000K	775Lm (4000K)	620Lm (4000K)	60°	36,00
DO54930	■ BLANC MAT	ALUMINIUM + COMPOSITE	6W	2700K 3000K 4000K	775Lm (4000K)	665Lm (4000K)	60°	36,00



NOIR MAT



BLANC MAT

KORY R SENSOR

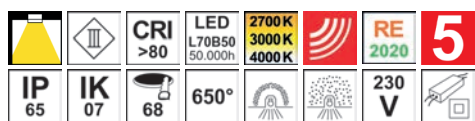

- Spot encastré rond fixe 3 en 1.
- 2700K, 3000K ou 4000K au choix via un interrupteur dans le luminaire.
- Fixation par ressorts.
- Peut être recouvert par un isolant déroulé ou soufflé, convertisseur compris.
- Double bornier automatique.
- Avec détecteur IR 90°, zone de détection max. 4m de diamètre.
- Fonction maître/esclave possible en association avec le KORY R.
- Convertisseur non dimmable déporté fourni.

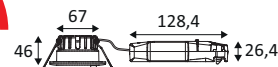

KORY R SENSOR	COULEUR	MATIÈRE	P	T°	LED LUMEN	SYSTEM LUMEN	α	€
DO55005	■ NOIR MAT	ALUMINIUM + COMPOSITE	6W	2700K 3000K 4000K	775Lm (4000K)	620Lm (4000K)	60°	44,00
DO55030	■ BLANC MAT	ALUMINIUM + COMPOSITE	6W	2700K 3000K 4000K	775Lm (4000K)	665Lm (4000K)	60°	44,00



NOIR MAT



BLANC MAT

KORY R SENSOR



AL1014 RX



- Spot encastré rond orientable.
- Fixation par ressorts.
- Peut être recouvert par un isolant déroulé.
- Double bornier automatique.
- Convertisseur non dimmable déporté fourni.
- Bague couvrant un diamètre de perçage de 90 à 120mm à commander séparément.

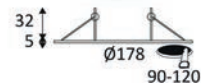
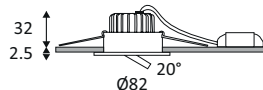

AL1014 RX	COULEUR	MATIÈRE	P	T°	LED LUMEN	SYSTEM LUMEN	α	€
AL101425	ALUMINIUM	FONTE D'ALUMINIUM	6W	3000K	760Lm	655Lm	38°	43,00
AL101430	BLANC MAT	FONTE D'ALUMINIUM	6W	3000K	760Lm	655Lm	38°	43,00
DO11525	ALUMINIUM	FONTE D'ALUMINIUM	6W	4000K	820Lm	705Lm	38°	48,00
DO11530	BLANC MAT	FONTE D'ALUMINIUM	6W	4000K	820Lm	705Lm	38°	48,00
ACCESSOIRES	COULEUR	MATIÈRE	DESCRIPTION					€
DO33330	BLANC MAT	ALUMINIUM	BAGUE DE MONTAGE 178MM					18,00



ALUMINIUM



BLANC MAT

AL1014 RDX

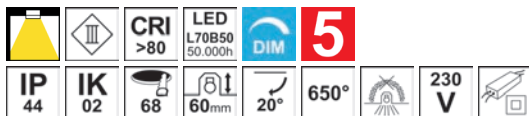

- Spot encastré rond orientable.
- Fixation par ressorts.
- Double bornier automatique.
- Convertisseur dimmable déporté fourni.
- Compatible avec variateur début et fin de phase.
- Bague couvrant un diamètre de perçage de 90 à 120mm à commander séparément.

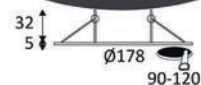
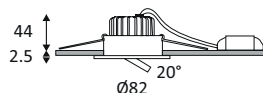

AL1014 RDX	COULEUR	MATIÈRE	P	T°	LED LUMEN	SYSTEM LUMEN	α	€
DO16005	NOIR MAT	FONTE D'ALUMINIUM	9W	3000K	940Lm	830Lm	38°	58,00
DO16025	ALUMINIUM	FONTE D'ALUMINIUM	9W	3000K	940Lm	830Lm	38°	58,00
DO16030	BLANC MAT	FONTE D'ALUMINIUM	9W	3000K	940Lm	830Lm	38°	50,00
ACCESSOIRES	COULEUR	MATIÈRE	DESCRIPTION					€
DO33305	NOIR MAT	ALUMINIUM	BAGUE DE MONTAGE 178MM					17,00
DO33330	BLANC MAT	ALUMINIUM	BAGUE DE MONTAGE 178MM					18,00



NOIR MAT



ALUMINIUM



BLANC MAT



AL2014 SDX

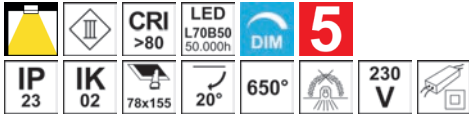

- Spot encastré rectangulaire orientable.
- Fixation par ressorts.
- Double bornier automatique.
- Convertisseur dimmable déporté fourni.
- Compatible avec variateur début et fin de phase.

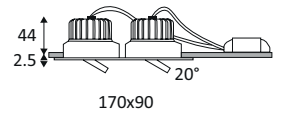

AL2014 SDX	COULEUR	MATIÈRE	P	T°	L(MM)	LED LUMEN	SYSTEM LUMEN	α	€
DO18205	■ NOIR MAT	FONTE D'ALUMINIUM	18W	3000K	170	2X900Lm	1570Lm	38°	156,00
DO18230	■ BLANC MAT	FONTE D'ALUMINIUM	18W	3000K	170	2X900Lm	1570Lm	38°	156,00



NOIR MAT

BLANC MAT

AL1015 RX



- Spot encastré rond orientable.
- Fixation par ressorts.
- Convertisseur non dimmable déporté fourni.
- En option, convertisseur dimmable DALI-PUSH CD140 à commander séparément.

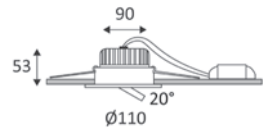

AL1015 RX	COULEUR	MATIÈRE	P	T°	LED LUMEN	SYSTEM LUMEN	α	€
DO108WW05	■ NOIR MAT	FONTE D'ALUMINIUM	12W	3000K	1320Lm	1170Lm	38°	114,00
DO108WW21	■ NICKEL SATINÉ	FONTE D'ALUMINIUM	12W	3000K	1100Lm	915Lm	38°	114,00
AL1015WW30	■ BLANC MAT	FONTE D'ALUMINIUM	12W	3000K	1320Lm	1170Lm	38°	114,00
DO108NW05	■ NOIR MAT	FONTE D'ALUMINIUM	12W	4000K	1200Lm	1000Lm	38°	114,00
DO108NW21	■ NICKEL SATINÉ	FONTE D'ALUMINIUM	12W	4000K	1200Lm	1000Lm	38°	114,00
DO108NW30	■ BLANC MAT	FONTE D'ALUMINIUM	12W	4000K	1470Lm	1300Lm	38°	114,00

CONVERTISSEURS ET SOURCES			WATT MAX	€
CD140	DRIVER 3-18W 350MA CC DIM DALI		3-18W	99,00



NOIR MAT

NICKEL SATINÉ

BLANC MAT

LARY RD

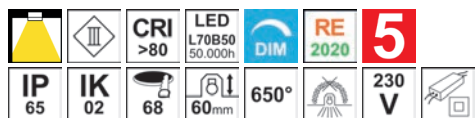

- Spot encastré rond fixe.
- Fixation par ressorts.
- Double bornier automatique.
- Convertisseur dimmable déporté fourni.
- Compatible avec variateur début et fin de phase.

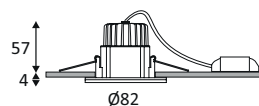

LARY RD	COULEUR	MATIÈRE	P	T°	LED LUMEN	SYSTEM LUMEN	α	€
DO442WW05	NOIR MAT	FONTE D'ALUMINIUM	9W	3000K	1050Lm	765Lm	38°	76,00
DO442WW21	NICKEL SATINÉ	FONTE D'ALUMINIUM	9W	3000K	1050Lm	910Lm	38°	78,00
DO442WW30	BLANC MAT	FONTE D'ALUMINIUM	9W	3000K	1050Lm	910Lm	38°	76,00
DO442NW05	NOIR MAT	FONTE D'ALUMINIUM	9W	4000K	1100Lm	805Lm	38°	76,00
DO442NW21	NICKEL SATINÉ	FONTE D'ALUMINIUM	9W	4000K	1100Lm	955Lm	38°	78,00
DO442NW30	BLANC MAT	FONTE D'ALUMINIUM	9W	4000K	1100Lm	955Lm	38°	76,00



NOIR MAT



NICKEL SATINÉ



BLANC MAT

LARY SD

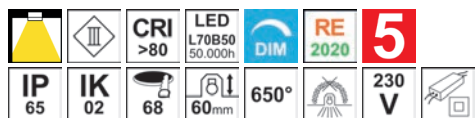

- Spot encastré carré fixe.
- Fixation par ressorts.
- Double bornier automatique.
- Convertisseur dimmable déporté fourni.
- Compatible avec variateur début et fin de phase.

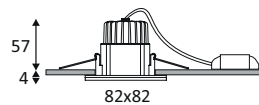

LARY SD	COULEUR	MATIÈRE	P	T°	L(MM)	LED LUMEN	SYSTEM LUMEN	α	€
DO443WW05	NOIR MAT	FONTE D'ALUMINIUM	9W	3000K	82	1050Lm	765Lm	38°	78,00
DO443WW21	NICKEL SATINÉ	FONTE D'ALUMINIUM	9W	3000K	82	1050Lm	910Lm	38°	78,00
DO443WW30	BLANC MAT	FONTE D'ALUMINIUM	9W	3000K	82	1050Lm	910Lm	38°	78,00
DO443NW05	NOIR MAT	FONTE D'ALUMINIUM	9W	4000K	82	1100Lm	805Lm	38°	78,00
DO443NW21	NICKEL SATINÉ	FONTE D'ALUMINIUM	9W	4000K	82	1100Lm	955Lm	38°	78,00
DO443NW30	BLANC MAT	FONTE D'ALUMINIUM	9W	4000K	82	1100Lm	955Lm	38°	78,00



NOIR MAT



NICKEL SATINÉ



BLANC MAT



IPHO 82 RD



- Spot encastré rond fixe.
- Fixation par ressorts.
- Double bornier automatique.
- Convertisseur dimmable déporté fourni.
- Compatible avec variateur début et fin de phase.

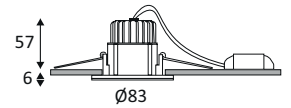

IPHO 82 RD	COULEUR	MATIÈRE	P	T°	LED LUMEN	SYSTEM LUMEN	α	€
DO16405	■ NOIR	VERRE	9W	3000K	900Lm	620Lm	38°	92,00
DO16430	■ BLANC	VERRE	9W	3000K	900Lm	705Lm	38°	92,00

DANS LA MÊME GAMME



NOIR



BLANC



IPHO R GU10 AUTO PAGE 32

IPHO 82 SD



- Spot encastré carré fixe.
- Fixation par ressorts.
- Double bornier automatique.
- Convertisseur dimmable déporté fourni.
- Compatible avec variateur début et fin de phase.

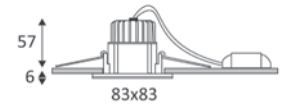

IPHO 82 SD	COULEUR	MATIÈRE	P	T°	L(MM)	LED LUMEN	SYSTEM LUMEN	α	€
DO16505	■ NOIR	VERRE	9W	3000K	83	900Lm	620Lm	38°	93,00
DO16530	■ BLANC	VERRE	9W	3000K	83	900Lm	705Lm	38°	93,00

DANS LA MÊME GAMME



NOIR



BLANC



IPHO S GU10 AUTO PAGE 32

COPE RD

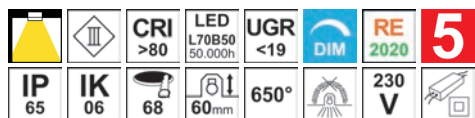

- Spot encastré rond fixe.
- Réflecteur basse luminance.
- Fixation par ressorts.
- Convertisseur dimmable déporté fourni.
- Compatible avec variateur début et fin de phase.

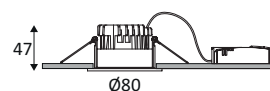

COPE RD	COULEUR	MATIÈRE	P	T°	LED LUMEN	SYSTEM LUMEN	α	€
DO465WW05	■ NOIR MAT	FONTE D'ALUMINIUM	7W	3000K	750Lm	620Lm	36°	73,00
DO465WW30	■ BLANC MAT	FONTE D'ALUMINIUM	7W	3000K	750Lm	620Lm	36°	73,00
DO465NW05	■ NOIR MAT	FONTE D'ALUMINIUM	7W	4000K	800Lm	645Lm	36°	73,00
DO465NW30	■ BLANC MAT	FONTE D'ALUMINIUM	7W	4000K	800Lm	645Lm	36°	73,00



NOIR MAT



BLANC MAT

EPI RD

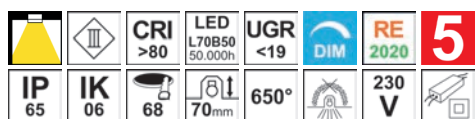

- Spot encastré rond fixe.
- Réflecteur basse luminance.
- Fixation par ressorts.
- Convertisseur dimmable déporté fourni.
- Compatible avec variateur début et fin de phase.

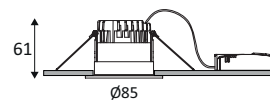

EPI RD	COULEUR	MATIÈRE	P	T°	LED LUMEN	SYSTEM LUMEN	α	€
DO466WW05	■ NOIR MAT	FONTE D'ALUMINIUM	7W	3000K	750Lm	570Lm	36°	78,00
DO466WW30	■ BLANC MAT	FONTE D'ALUMINIUM	7W	3000K	750Lm	570Lm	36°	78,00
DO466NW05	■ NOIR MAT	FONTE D'ALUMINIUM	7W	4000K	800Lm	600Lm	36°	78,00
DO466NW30	■ BLANC MAT	FONTE D'ALUMINIUM	7W	4000K	800Lm	600Lm	36°	78,00



NOIR MAT



BLANC MAT

COPE RD



SWEET RD EVO

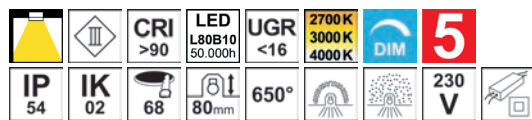

- Spot encastré rond fixe.
- Réflecteur basse luminance.
- 2700K, 3000K ou 4000K au choix via un interrupteur sur le convertisseur.
- Fixation par ressorts.
- Peut être recouvert par un isolant déroulé ou soufflé.
- Double bornier automatique.
- Convertisseur dimmable déporté fourni.
- Compatible avec variateur fin de phase.
- Bague couvrant un diamètre de perçage de 90 à 120mm à commander séparément.
- Driver ou source de remplacement disponibles séparément.

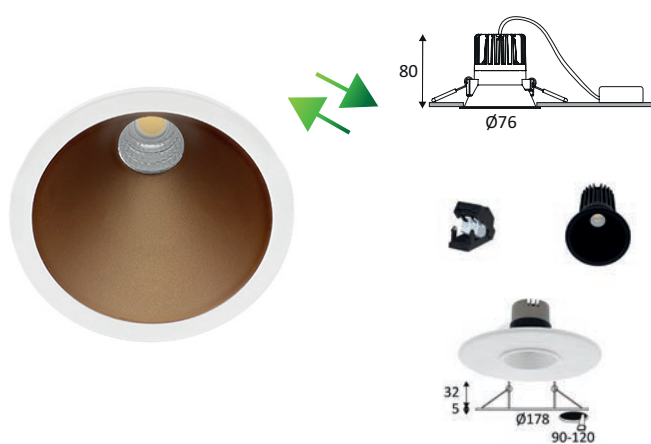

SWEET RD EVO	COULEUR	MATIÈRE	P	T°	LED LUMEN	SYSTEM LUMEN	α	€
DO56405	NEW NOIR MAT	POLYCARBONATE	7,5W	2700K 3000K 4000K	740Lm (4000K)	505Lm (4000K)	60°	50,00
DO56430	NEW BLANC MAT	POLYCARBONATE	7,5W	2700K 3000K 4000K	740Lm (4000K)	575Lm (4000K)	60°	50,00
DO56449	NEW BLANC MAT - CHAMPAGNE	POLYCARBONATE	7,5W	2700K 3000K 4000K	740Lm (4000K)	575Lm (4000K)	60°	50,00
DO56453	NEW BLANC MAT - ARGENT	POLYCARBONATE	7,5W	2700K 3000K 4000K	740Lm (4000K)	575Lm (4000K)	60°	50,00
DO56481	NEW BLANC MAT - NOIR	POLYCARBONATE	7,5W	2700K 3000K 4000K	740Lm (4000K)	505Lm (4000K)	60°	50,00

ACCESSOIRES	COULEUR	MATIÈRE	DESCRIPTION	€
DO33305	NOIR MAT	ALUMINIUM	BAGUE DE MONTAGE 178MM	17,00
DO33330	BLANC MAT	ALUMINIUM	BAGUE DE MONTAGE 178MM	18,00

CONVERTISSEURS ET SOURCES	LED	WATT MAX	€
CD562	DRIVER 5-7W 180MA CC DIM	NEW 5-7W	20,00
LP564	SOURCE LED 6W 740Lm 60°	NEW 6W	20,00



NOIR MAT



BLANC MAT

BLANC MAT -
CHAMPAGNEBLANC MAT -
ARGENT

BLANC MAT - NOIR

SWEET RD EVO



- Peut être recouvert par un isolant déroulé ou soufflé.
- Compatible avec variateur fin de phase.
- Bague couvrant un diamètre de perçage de 90 à 120mm, driver ou source de remplacement disponibles séparément.

SILK RDX

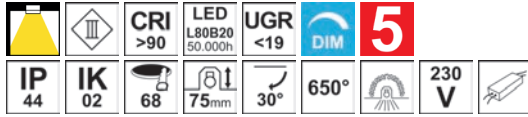

- Spot encastré rond orientable.
- Réflecteur basse luminance.
- Fixation par ressorts.
- Peut être recouvert par un isolant déroulé.
- Double bornier automatique.
- Convertisseur dimmable déporté fourni.
- Compatible avec variateur fin de phase.
- Bague couvrant un diamètre de perçage de 90 à 120mm à commander séparément.

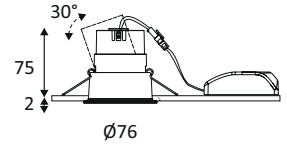

SILK RDX	COULEUR	MATIÈRE	P	T°	LED LUMEN	SYSTEM LUMEN	α	€
DO501WW05	NOIR MAT	FONTE D'ALUMINIUM	6W	3000K	630Lm	490Lm	36°	64,00
DO501WW08	NOIR MAT - CHAMPAGNE	FONTE D'ALUMINIUM	6W	3000K	630Lm	490Lm	36°	64,00
DO501WW17	NOIR MAT - ARGENT	FONTE D'ALUMINIUM	6W	3000K	630Lm	490Lm	36°	65,00
DO501WW06	NOIR MAT - OR ROSE	FONTE D'ALUMINIUM	6W	3000K	630Lm	490Lm	36°	65,00
DO501WW30	BLANC MAT	FONTE D'ALUMINIUM	6W	3000K	630Lm	510Lm	36°	62,00
DO501WW49	BLANC MAT - CHAMPAGNE	FONTE D'ALUMINIUM	6W	3000K	630Lm	510Lm	36°	65,00
DO501WW53	BLANC MAT - ARGENT	FONTE D'ALUMINIUM	6W	3000K	630Lm	510Lm	36°	65,00
DO501WW02	BLANC MAT - OR ROSE	FONTE D'ALUMINIUM	6W	3000K	630Lm	510Lm	36°	63,00

ACCESSOIRES	COULEUR	MATIÈRE	DESCRIPTION	€
DO33330	BLANC MAT	ALUMINIUM	BAGUE DE MONTAGE 178MM	18,00
DO33305	NOIR MAT	ALUMINIUM	BAGUE DE MONTAGE 178MM	17,00



NOIR MAT

NOIR MAT -
CHAMPAGNE

NOIR MAT - ARGENT

NOIR MAT - OR
ROSE

BLANC MAT

BLANC MAT -
CHAMPAGNEBLANC MAT -
ARGENTBLANC MAT - OR
ROSE



SILK RDX WARM

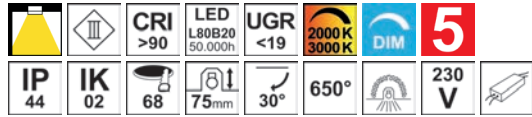

- Spot encastré rond orientable.
- Réflecteur basse luminance.
- Fixation par ressorts.
- Peut être recouvert par un isolant déroulé.
- Double bornier automatique.
- Température de couleur variable de 2000K à 3000K suivant l'intensité de dimming.
- Convertisseur dimmable déporté fourni.
- Compatible avec variateur fin de phase.
- Bague couvrant un diamètre de perçage de 90 à 120mm à commander séparément.

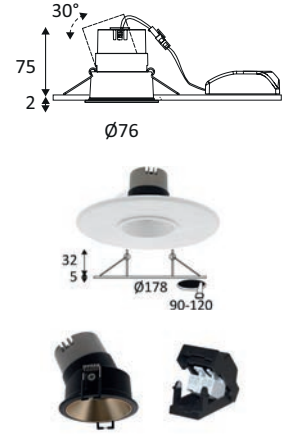

SILK RDX WARM	COULEUR	MATIÈRE	P	T°	LED LUMEN	SYSTEM LUMEN	α	€
DO50205	NOIR MAT	FONTE D'ALUMINIUM	6W	2000K > 3000K	530Lm	410Lm	36°	62,00
DO50208	NOIR MAT - CHAMPAGNE	FONTE D'ALUMINIUM	6W	2000K > 3000K	530Lm	410Lm	36°	65,00
DO50217	NOIR MAT - ARGENT	FONTE D'ALUMINIUM	6W	2000K > 3000K	530Lm	410Lm	36°	65,00
DO50206	NOIR MAT - OR ROSE	FONTE D'ALUMINIUM	6W	2000K > 3000K	530Lm	410Lm	36°	65,00
DO50230	BLANC MAT	FONTE D'ALUMINIUM	6W	2000K > 3000K	530Lm	430Lm	36°	62,00
DO50249	BLANC MAT - CHAMPAGNE	FONTE D'ALUMINIUM	6W	2000K > 3000K	530Lm	430Lm	36°	65,00
DO50253	BLANC MAT - ARGENT	FONTE D'ALUMINIUM	6W	2000K > 3000K	530Lm	430Lm	36°	65,00
DO50202	BLANC MAT - OR ROSE	FONTE D'ALUMINIUM	6W	2000K > 3000K	530Lm	430Lm	36°	65,00

ACCESSOIRES	COULEUR	MATIÈRE	DESCRIPTION	€
DO33330	BLANC MAT	ALUMINIUM	BAGUE DE MONTAGE 178MM	18,00
DO33305	NOIR MAT	ALUMINIUM	BAGUE DE MONTAGE 178MM	17,00



AL3012 RD

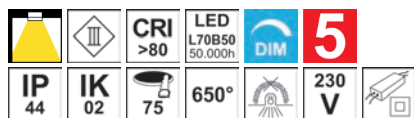

- Spot encastré rond fixe.
- Réflecteur basse luminance.
- Fixation par ressorts.
- Convertisseur dimmable déporté fourni.
- Compatible avec variateur début et fin de phase.

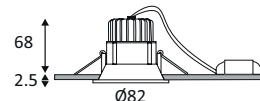

AL3012 RD	COULEUR	MATIÈRE	P	T°	LED LUMEN	SYSTEM LUMEN	α	€
DO17105	■ NOIR MAT	FONTE D'ALUMINIUM	9W	3000K	1050Lm	820Lm	38°	73,00
DO17130	■ BLANC MAT	FONTE D'ALUMINIUM	9W	3000K	1050Lm	865Lm	38°	73,00
DO17144	■ BLANC MAT - DORÉ	FONTE D'ALUMINIUM	9W	3000K	1050Lm	865Lm	38°	81,00

DANS LA MÊME GAMME



NOIR MAT



BLANC MAT



BLANC MAT - DORÉ



AL3012 RD OUT PAGE 534

AL3012 RD WARM

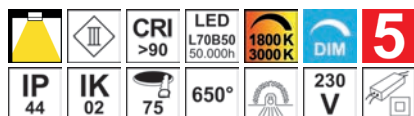

- Spot encastré rond fixe.
- Réflecteur basse luminance.
- Fixation par ressorts.
- Peut être recouvert par un isolant déroulé.
- Température de couleur variable de 1800K à 3000K suivant l'intensité de dimming.
- Convertisseur dimmable déporté fourni.
- Compatible avec variateur début et fin de phase.

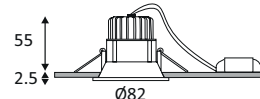

AL3012 RD WARM	COULEUR	MATIÈRE	P	T°	LED LUMEN	SYSTEM LUMEN	α	€
DO33005	■ NOIR MAT	FONTE D'ALUMINIUM	6W	1800K> 3000K	530Lm	405Lm	38°	98,00
DO33030	■ BLANC MAT	FONTE D'ALUMINIUM	6W	1800K> 3000K	530Lm	425Lm	38°	98,00

DANS LA MÊME GAMME



NOIR MAT



BLANC MAT



AL3012 RD OUT PAGE 534



SYLA RD-B

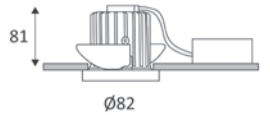
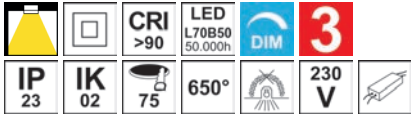

- Spot encastré rond fixe.
- Réflecteur basse luminance.
- Fixation par lamelles.
- Convertisseur dimmable déporté fourni.

SYLA RD-B	COULEUR	MATIÈRE	P	T°	LED LUMEN	SYSTEM LUMEN	α	€
DO221SW05	NOIR MAT	FONTE D'ALUMINIUM	10W	2700K	960Lm	775Lm	38°	86,00
DO221SW18	NOIR - DORÉ	FONTE D'ALUMINIUM	10W	2700K	960Lm	775Lm	38°	103,00
DO221SW30	BLANC MAT	FONTE D'ALUMINIUM	10W	2700K	960Lm	775Lm	38°	86,00
DO221WW05	NOIR MAT	FONTE D'ALUMINIUM	10W	3000K	1010Lm	850Lm	38°	86,00
DO221WW18	NOIR - DORÉ	FONTE D'ALUMINIUM	10W	3000K	1010Lm	850Lm	38°	104,00
DO221WW30	BLANC MAT	FONTE D'ALUMINIUM	10W	3000K	1010Lm	850Lm	38°	86,00

ACCESSOIRES	COULEUR	DESCRIPTION	L(MM)	€
DO33905	NOIR MAT	BAGUE CARREE 100X100MM	100	14,00
DO33930	BLANC MAT	BAGUE CARREE 100X100MM	100	14,00
DO34005	NOIR MAT	BAGUE RECTANGULAIRE 195X100MM	195	30,00
DO34030	BLANC MAT	BAGUE RECTANGULAIRE 195X100MM	195	30,00



NOIR MAT



NOIR - DORÉ



BLANC MAT



ABY 1 RD

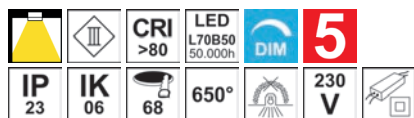

- Spot encastré rond fixe.
- Réflecteur basse luminance.
- Fixation par ressorts.
- Convertisseur dimmable déporté fourni.
- Compatible avec variateur début et fin de phase.

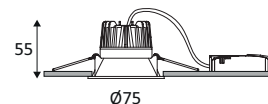

ABY 1 RD	COULEUR	MATIÈRE	P	T°	LED LUMEN	SYSTEM LUMEN	α	€
DO461WW05	■ NOIR MAT	FONTE D'ALUMINIUM	6,5W	3000K	550Lm	520Lm	36°	63,00
DO461WW30	■ BLANC MAT	FONTE D'ALUMINIUM	6,5W	3000K	550Lm	520Lm	36°	63,00
DO461NW05	■ NOIR MAT	FONTE D'ALUMINIUM	6,5W	4000K	800Lm	600Lm	36°	63,00
DO461NW30	■ BLANC MAT	FONTE D'ALUMINIUM	6,5W	4000K	800Lm	600Lm	36°	63,00



NOIR MAT



BLANC MAT

ABY 2 RD

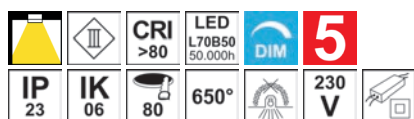

- Spot encastré rond fixe.
- Réflecteur basse luminance.
- Fixation par ressorts.
- Convertisseur dimmable déporté fourni.
- Compatible avec variateur début et fin de phase.

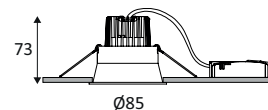

ABY 2 RD	COULEUR	MATIÈRE	P	T°	LED LUMEN	SYSTEM LUMEN	α	€
DO462WW05	■ NOIR MAT	FONTE D'ALUMINIUM	9W	3000K	750Lm	680Lm	36°	73,00
DO462WW30	■ BLANC MAT	FONTE D'ALUMINIUM	9W	3000K	750Lm	680Lm	36°	73,00
DO462NW05	■ NOIR MAT	FONTE D'ALUMINIUM	9W	4000K	950Lm	860Lm	36°	73,00
DO462NW30	■ BLANC MAT	FONTE D'ALUMINIUM	9W	4000K	950Lm	860Lm	36°	73,00



NOIR MAT



BLANC MAT



ABY 3 RD

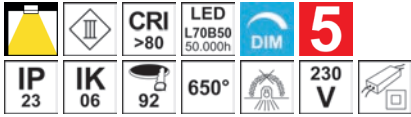

- Spot encastré rond fixe.
- Réflecteur basse luminance.
- Fixation par ressorts.
- Convertisseur dimmable déporté fourni.
- Compatible avec variateur début et fin de phase.

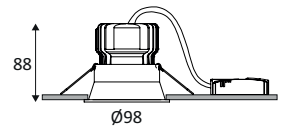

ABY 3 RD	COULEUR	MATIÈRE	P	T°	LED LUMEN	SYSTEM LUMEN	α	€
DO464WW05	■ NOIR MAT	FONTE D'ALUMINIUM	15W	3000K	1300Lm	1150Lm	45°	95,00
DO464WW30	■ BLANC MAT	FONTE D'ALUMINIUM	15W	3000K	1300Lm	1150Lm	45°	95,00
DO464NW05	■ NOIR MAT	FONTE D'ALUMINIUM	15W	4000K	1700Lm	1445Lm	45°	95,00
DO464NW30	■ BLANC MAT	FONTE D'ALUMINIUM	15W	4000K	1700Lm	1445Lm	45°	95,00



NOIR MAT



BLANC MAT

ABY 2 RD



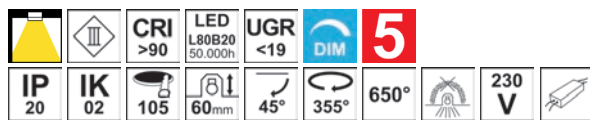

ALLY 3 RDX

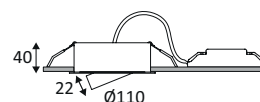

- Spot encastré rond orientable.
- Fixation par ressorts.
- Convertisseur dimmable déporté fourni.
- Compatible avec variateur début et fin de phase.
- En option, convertisseur dimmable DALI-PUSH CD123 à commander séparément.



ALLY 3 RDX	COULEUR	MATIÈRE	P	T°	LED LUMEN	SYSTEM LUMEN	α	€
DO529WW05	■ NOIR MAT	ALUMINIUM	10W	3000K	1025Lm	715Lm	38°	124,00
DO529WW30	■ BLANC MAT	ALUMINIUM	10W	3000K	1025Lm	715Lm	38°	124,00
CONVERTISSEURS ET SOURCES			WATT MAX	€	DANS LA MÊME GAMME			
CD123	DRIVER 3-18W 250MA CC DIM DALI		 3-18W	86,00		ALLY 1 RDX PAGE 90		



NOIR MAT



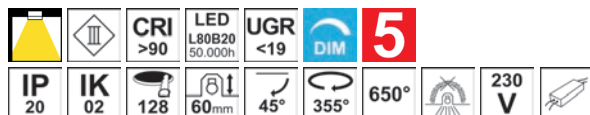

BLANC MAT

ALLY 4 RDX

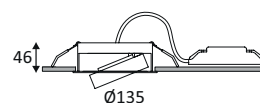

- Spot encastré rond orientable.
- Fixation par ressorts.
- Convertisseur dimmable déporté fourni.
- Compatible avec variateur début et fin de phase.
- En option, convertisseur dimmable DALI-PUSH CD140 à commander séparément.



ALLY 4 RDX	COULEUR	MATIÈRE	P	T°	LED LUMEN	SYSTEM LUMEN	α	€
DO530WW05	■ NOIR MAT	ALUMINIUM	14W	3000K	1270Lm	925Lm	38°	143,00
DO530WW30	■ BLANC MAT	ALUMINIUM	14W	3000K	1270Lm	925Lm	38°	143,00
CONVERTISSEURS ET SOURCES			WATT MAX	€	DANS LA MÊME GAMME			
CD140	DRIVER 3-18W 350MA CC DIM DALI		 3-18W	99,00		ALLY 2 RDX PAGE 91		



NOIR MAT



BLANC MAT

ALLY 4 RDX



DOTS

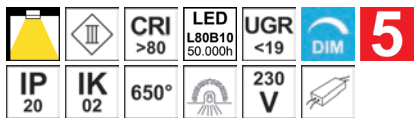

- Spot encastré pour éclairage d'accentuation.
- Réflecteur basse luminance.
- Fixation par ressorts.
- Convertisseur dimmable déporté fourni.
- DO497, DO498 et DO499 en version DALI : convertisseur avec fonction push-dim.

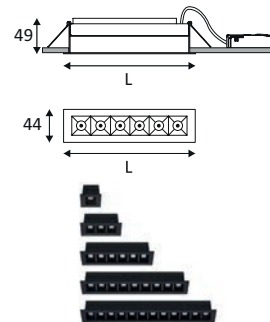

DOTS	COULEUR	MATIÈRE	P	T°	L(MM)	LED LUMEN	SYSTEM LUMEN	α	€		
DIMMABLE COUPURE DE PHASE											
		DO500WW05	■ NOIR MAT	ALUMINIUM	3W	3000K	48	320Lm	150Lm	45°	44,00
		DO500WW30	■ BLANC MAT	ALUMINIUM	3W	3000K	48	320Lm	150Lm	45°	44,00
		DO496WW05	■ NOIR MAT	ALUMINIUM	6W	3000K	102	470Lm	345Lm	45°	54,00
		DO496WW30	■ BLANC MAT	ALUMINIUM	6W	3000K	102	470Lm	345Lm	45°	54,00
		DO497WW05	■ NOIR MAT	ALUMINIUM	12W	3000K	182	940Lm	610Lm	45°	79,00
		DO497WW30	■ BLANC MAT	ALUMINIUM	12W	3000K	182	940Lm	610Lm	45°	79,00
		DO498WW05	■ NOIR MAT	ALUMINIUM	16W	3000K	262	1400Lm	1010Lm	45°	102,00
		DO498WW30	■ BLANC MAT	ALUMINIUM	16W	3000K	262	1400Lm	1010Lm	45°	102,00
		DO499WW05	■ NOIR MAT	ALUMINIUM	20W	3000K	342	1880Lm	1215Lm	45°	116,00
		DO499WW30	■ BLANC MAT	ALUMINIUM	20W	3000K	342	1880Lm	1215Lm	45°	116,00
DIMMABLE DALI											
		DO500WW05DA	■ NOIR MAT	ALUMINIUM	3W	3000K	48	320Lm	150Lm	45°	132,00
		DO500WW30DA	■ BLANC MAT	ALUMINIUM	3W	3000K	48	320Lm	150Lm	45°	132,00
		DO496WW05DA	■ NOIR MAT	ALUMINIUM	6W	3000K	102	470Lm	345Lm	45°	117,00
		DO496WW30DA	■ BLANC MAT	ALUMINIUM	6W	3000K	102	470Lm	345Lm	45°	117,00
		DO497WW05DA	■ NOIR MAT	ALUMINIUM	12W	3000K	182	940Lm	610Lm	45°	192,00
		DO497WW30DA	■ BLANC MAT	ALUMINIUM	12W	3000K	182	940Lm	610Lm	45°	192,00
		DO498WW05DA	■ NOIR MAT	ALUMINIUM	16W	3000K	262	1400Lm	1010Lm	45°	205,00
		DO498WW30DA	■ BLANC MAT	ALUMINIUM	16W	3000K	262	1400Lm	1010Lm	45°	205,00
		DO499WW05DA	■ NOIR MAT	ALUMINIUM	20W	3000K	342	1880Lm	1215Lm	45°	226,00
		DO499WW30DA	■ BLANC MAT	ALUMINIUM	20W	3000K	342	1880Lm	1215Lm	45°	226,00

DANS LA MÊME GAMME

DOTS C PAGE 214

NOIR MAT

BLANC MAT

DOTS



- Spot encastré d'accentuation au design sobre et moderne.
- Excellent confort visuel grâce à un UGR inférieur à 19.
- Large choix de dimensions et de puissances.
- Garantie de 5 ans.

INDIGO

LIGHTING



SEMI-ENCASTRÉS



SIRA R

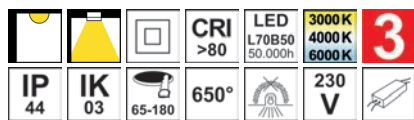

- Downlight rond fixe 3 en 1.
- Montage apparent ou semi-encasté.
- 3000K, 4000K ou 6000K au choix via un interrupteur à l'arrière du luminaire.
- Fixation par ressorts ajustables pour couvrir les diamètres d'encastrement de 65 à 180mm.
- Convertisseur non dimmable intégré dans l'appareil.

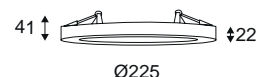

SIRA R	COULEUR	MATIÈRE	P	T°	LED LUMEN	SYSTEM LUMEN	α	€
DO36630	BLANC MAT	COMPOSITE	18W	3000K 4000K 6000K	2150Lm (4000K)	1600Lm (4000K)	110°	50,00

SIRA R SENSOR IR



- Downlight rond fixe 3 en 1.
- Montage apparent ou semi-encasté.
- Multi-puissance : 12, 15 ou 18W au choix via un interrupteur à l'arrière du luminaire.
- 3000K, 4000K ou 6000K au choix via un interrupteur à l'arrière du luminaire.
- Avec détecteur IR 120°, zone de détection 3m de diamètre.
- Fixation par ressorts ajustables pour couvrir les diamètres d'encastrement de 65 à 180mm.
- Convertisseur non dimmable intégré dans l'appareil.



SIRA R SENSOR IR	COULEUR	MATIÈRE	LED	T°	LED LUMEN	SYSTEM LUMEN	α	€
DO49530	BLANC MAT	COMPOSITE	12W 15W 18W	3000K 4000K 6000K	1550Lm (4000K) 1910Lm (4000K) 2150Lm (4000K)	1190Lm (4000K) 1470Lm (4000K) 1660Lm (4000K)	110°	87,00

SIRA R SENSOR IR



FILI 1 RX GU10 AUTO

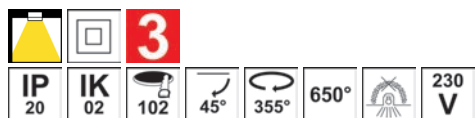

- Spot semi-encastré rond orientable.
- Fixation par ressorts.
- Double bornier automatique.

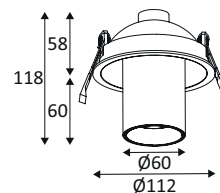

FILI 1 RX GU10 AUTO	COULEUR	MATIÈRE	SOQUET	LAMPE	WATT MAX	€
DO44405	■ NOIR MAT	ALUMINIUM	GU10	PAR16 LED	10W	61,00
DO44430	■ BLANC MAT	ALUMINIUM	GU10	PAR16 LED	10W	61,00

DANS LA MÊME GAMME



NOIR MAT



BLANC MAT



FILI 1 RX-B PAGE 98

FILI 5 RX-B GU10 AUTO

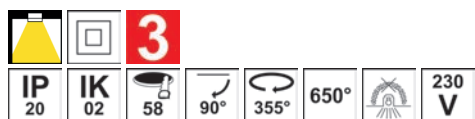

- Spot semi-encastré rond orientable.
- Fixation par lamelles.
- Livré avec réflecteur doré.
- Double bornier automatique.

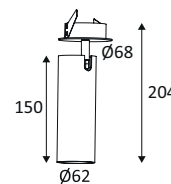

FILI 5 RX-B GU10 AUTO	COULEUR	MATIÈRE	SOQUET	LAMPE	WATT MAX	€
DO49105	■ NOIR MAT	ALUMINIUM	GU10	PAR16 LED	10W	71,00
DO49130	■ BLANC MAT	ALUMINIUM	GU10	PAR16 LED	10W	71,00

DANS LA MÊME GAMME



NOIR MAT



BLANC MAT



FILI 5 RDX-B PAGE 98



OKTO RX GU10



- Spot semi-encastré rond orientable.
- Fixation par ressorts.

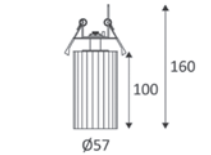

OKTO RX GU10	COULEUR	MATIÈRE	SOQUET	LAMPE	WATT MAX	€
DO51505	■ NOIR MAT	ALUMINIUM	GU10	PAR16 LED	10W	43,00
DO51508	■ NOIR MAT - CHAMPAGNE	ALUMINIUM	GU10	PAR16 LED	10W	47,00
DO51506	■ NOIR MAT - OR ROSE	ALUMINIUM	GU10	PAR16 LED	10W	47,00
DO51583	■ NOIR MAT - ROSE	ALUMINIUM	GU10	PAR16 LED	10W	47,00
DO51530	■ BLANC MAT	ALUMINIUM	GU10	PAR16 LED	10W	43,00
DO51549	■ BLANC MAT - CHAMPAGNE	ALUMINIUM	GU10	PAR16 LED	10W	47,00
DO51502	■ BLANC MAT - OR ROSE	ALUMINIUM	GU10	PAR16 LED	10W	47,00
DO51582	■ BLANC MAT - ROSE	ALUMINIUM	GU10	PAR16 LED	10W	47,00

DANS LA MÊME GAMME



NOIR MAT

NOIR MAT -
CHAMPAGNENOIR MAT - OR
ROSE

NOIR MAT - ROSE



BLANC MAT

BLANC MAT -
CHAMPAGNEBLANC MAT - OR
ROSE

BLANC MAT - ROSE



OKTO GU10 PAGE 182



OKTO 1 C GU10 PAGE 184



OKTO 2 GU10 PAGE 149



OKTO 2 C GU10 PAGE 185



OKTO 4 C GU10 PAGE 186



OKTO C GU10 PAGE 183



OKTO P GU10 PAGE 218



CLARA 1 RDX

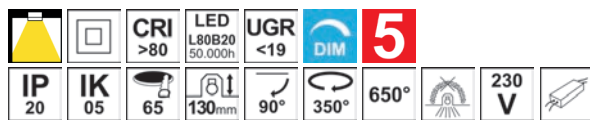

- Spot semi-encastré rond orientable.
- Fixation par ressorts.
- Convertisseur dimmable déporté fourni.
- Compatible avec variateur début et fin de phase.

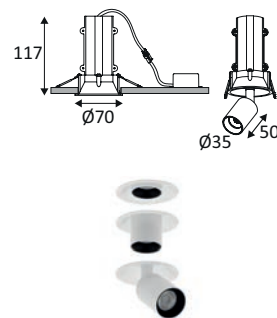

CLARA 1 RDX	COULEUR	MATIÈRE	P	T°	LED LUMEN	SYSTEM LUMEN	α	€
DO534WW05	■ NOIR MAT	ALUMINIUM	3W	3000K	670Lm	260Lm	36°	80,00
DO534WW30	■ BLANC MAT	ALUMINIUM	3W	3000K	670Lm	260Lm	36°	80,00



NOIR MAT

BLANC MAT

CLARA 2 RDX

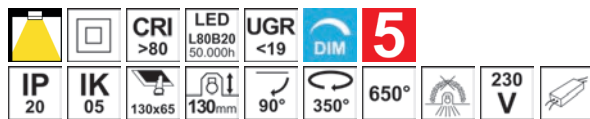

- Spot semi-encastré orientable.
- Fixation par ressorts.
- Convertisseur dimmable déporté fourni.
- Compatible avec variateur début et fin de phase.

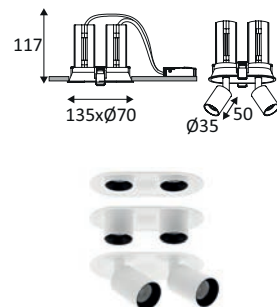

CLARA 2 RDX	COULEUR	MATIÈRE	P	T°	L(MM)	LED LUMEN	SYSTEM LUMEN	α	€
DO535WW05	■ NOIR MAT	ALUMINIUM	6W	3000K	135	2X670Lm	2X520Lm	36°	133,00
DO535WW30	■ BLANC MAT	ALUMINIUM	6W	3000K	135	2X670Lm	2X520Lm	36°	133,00



NOIR MAT

BLANC MAT

CLARA 1 RDX



ALLY 1 RX

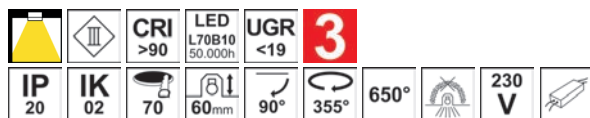

- Spot semi-encastré rond orientable.
- Fixation par ressorts.
- Convertisseur non dimmable déporté fourni.
- En option, convertisseur dimmable DALI-PUSH CD123 à commander séparément.

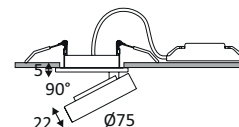

ALLY 1 RX	COULEUR	MATIÈRE	P	T°	LED LUMEN	SYSTEM LUMEN	α	€
DO507WW05	■ NOIR MAT	ALUMINIUM	9W	3000K	675Lm	490Lm	38°	105,00
DO507WW30	■ BLANC MAT	ALUMINIUM	9W	3000K	675Lm	490Lm	38°	105,00
CONVERTISSEURS ET SOURCES			WATT MAX	€				
CD123	DRIVER 3-18W 250MA CC DIM DALI		3-18W	86,00				



NOIR MAT



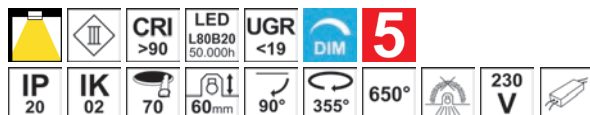

BLANC MAT

ALLY 1 RDX

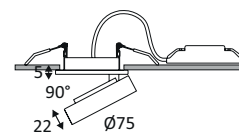

- Spot semi-encastré rond orientable.
- Fixation par ressorts.
- Convertisseur dimmable déporté fourni.
- Compatible avec variateur début et fin de phase.
- En option, convertisseur dimmable DALI-PUSH CD123 à commander séparément.



ALLY 1 RDX	COULEUR	MATIÈRE	P	T°	LED LUMEN	SYSTEM LUMEN	α	€
DO527WW05	■ NOIR MAT	ALUMINIUM	10W	3000K	1025Lm	715Lm	38°	119,00
DO527WW30	■ BLANC MAT	ALUMINIUM	10W	3000K	1025Lm	715Lm	38°	119,00
CONVERTISSEURS ET SOURCES			WATT MAX	€	DANS LA MÊME GAMME			
CD123	DRIVER 3-18W 250MA CC DIM DALI		3-18W	86,00		ALLY 3 RDX PAGE 78		



NOIR MAT



BLANC MAT



ALLY 2 RX

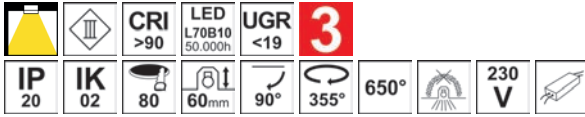

- Spot semi-encastré rond orientable.
- Fixation par ressorts.
- Convertisseur non dimmable déporté fourni.
- En option, convertisseur dimmable DALI-PUSH CD140 à commander séparément.

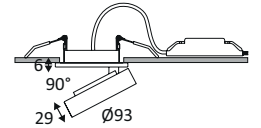

ALLY 2 RX	COULEUR	MATIÈRE	P	T°	LED LUMEN	SYSTEM LUMEN	α	€
DO508WW05	■ NOIR MAT	ALUMINIUM	13W	3000K	1160Lm	805Lm	38°	125,00
DO508WW30	■ BLANC MAT	ALUMINIUM	13W	3000K	1160Lm	805Lm	38°	125,00
CONVERTISSEURS ET SOURCES			WATT MAX	€				
CD140	DRIVER 3-18W 350MA CC DIM DALI		3-18W	99,00				



NOIR MAT



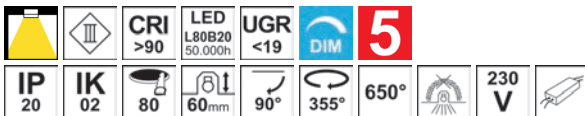

BLANC MAT

ALLY 2 RDX

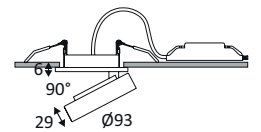

- Spot semi-encastré rond orientable.
- Fixation par ressorts.
- Convertisseur dimmable déporté fourni.
- Compatible avec variateur début et fin de phase.
- En option, convertisseur dimmable DALI-PUSH CD140 à commander séparément.



ALLY 2 RDX	COULEUR	MATIÈRE	P	T°	LED LUMEN	SYSTEM LUMEN	α	€
DO528WW05	■ NOIR MAT	ALUMINIUM	14W	3000K	1270Lm	925Lm	38°	135,00
DO528WW30	■ BLANC MAT	ALUMINIUM	14W	3000K	1270Lm	925Lm	38°	135,00
CONVERTISSEURS ET SOURCES			WATT MAX	€	DANS LA MÊME GAMME			
CD140	DRIVER 3-18W 350MA CC DIM DALI		3-18W	99,00		ALLY 4 RDX PAGE 78		



NOIR MAT



BLANC MAT

CLIC RDX MINI

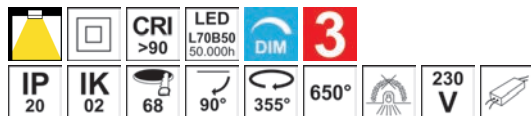

- Spot semi-encastré rond orientable.
- Fixation par ressorts.
- Convertisseur dimmable déporté fourni.
- Compatible avec variateur fin de phase.

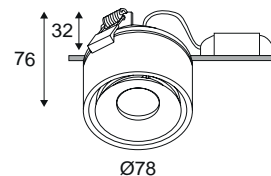

CLIC RDX MINI	COULEUR	MATIÈRE	P	T°	LED LUMEN	SYSTEM LUMEN	α	€
DO365SW05	NOIR MAT	ALUMINIUM	8W	2700K	710Lm	435Lm	38°	123,00
DO365SW30	BLANC MAT	ALUMINIUM	9W	2700K	920Lm	560Lm	38°	123,00
DO365WW05	NOIR MAT	ALUMINIUM	9W	3000K	930Lm	630Lm	38°	123,00
DO365WW30	BLANC MAT	ALUMINIUM	9W	3000K	930Lm	680Lm	38°	123,00

DANS LA MÊME GAMME



NOIR MAT



BLANC MAT



CLAC 1 MINI PAGE 197



CLAC 2 MINI PAGE 197

CLIC RDX

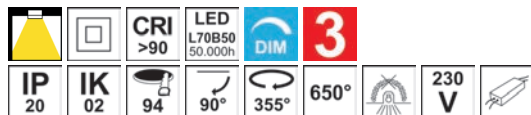

- Spot semi-encastré rond orientable.
- Fixation par ressorts.
- Convertisseur dimmable déporté fourni.
- Compatible avec variateur fin de phase.
- En option, convertisseur dimmable DALI-PUSH CD124 à commander séparément.

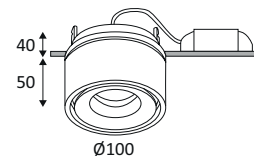

CLIC RDX	COULEUR	MATIÈRE	P	T°	LED LUMEN	SYSTEM LUMEN	α	€
DO224SW05	NOIR MAT	ALUMINIUM	13W	2700K	1120Lm	800Lm	38°	174,00
DO224SW30	BLANC MAT	ALUMINIUM	13W	2700K	1120Lm	800Lm	38°	174,00
DO224WW05	NOIR MAT	ALUMINIUM	13W	3000K	1570Lm	905Lm	38°	182,00
DO224WW30	BLANC MAT	ALUMINIUM	13W	3000K	1570Lm	1020Lm	38°	182,00

CONVERTISSEURS ET SOURCES

WATT MAX

€

DANS LA MÊME GAMME

CD124 DRIVER 3-18W 300MA CC DIM DALI



3-18W

88,00



CLAC PAGE 198



NOIR MAT



BLANC MAT

CLIC RDX MINI



CLIC RDX



RETI 1 RX

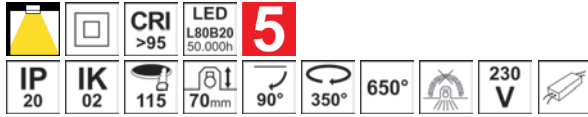

- Downlight semi-encastré rond orientable.
- Faisceau lumineux précisément dessiné grâce à une lentille en verre de haute qualité.
- Fixation par ressorts.
- Convertisseur non dimmable déporté fourni.

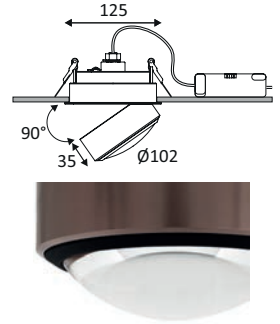

RETI 1 RX	COULEUR	MATIÈRE	P	T°	LED LUMEN	SYSTEM LUMEN	α	€
DO560WW05	NEW NOIR MAT	ALUMINIUM	18W	3000K	1620Lm	1490Lm	80°	239,00
DO560WW31	NEW NOIR MAT - BRONZE SATINÉ	ALUMINIUM	18W	3000K	1620Lm	1490Lm	80°	239,00
DO560WW30	NEW BLANC MAT	ALUMINIUM	18W	3000K	1620Lm	1490Lm	80°	239,00

DANS LA MÊME GAMME



NOIR MAT NOIR MAT - BRONZE SATINÉ BLANC MAT



RETI W PAGE 152



RETI P PAGE 222

RETI 2 RX

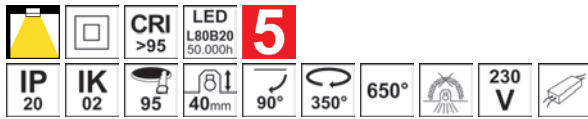

- Downlight semi-encastré rond orientable.
- Faisceau lumineux précisément dessiné grâce à une lentille en verre de haute qualité.
- Fixation par ressorts.
- Convertisseur non dimmable déporté fourni.

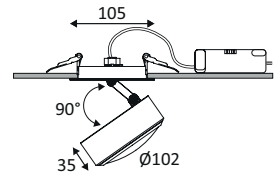

RETI 2 RX	COULEUR	MATIÈRE	P	T°	LED LUMEN	SYSTEM LUMEN	α	€
DO561WW05	NEW NOIR MAT	ALUMINIUM	18W	3000K	1620Lm	1490Lm	80°	233,00
DO561WW31	NEW NOIR MAT - BRONZE SATINÉ	ALUMINIUM	18W	3000K	1620Lm	1490Lm	80°	233,00
DO561WW30	NEW BLANC MAT	ALUMINIUM	18W	3000K	1620Lm	1490Lm	80°	233,00

DANS LA MÊME GAMME



NOIR MAT NOIR MAT - BRONZE SATINÉ BLANC MAT



RETI W PAGE 152



RETI P PAGE 222



RETI 1 RX

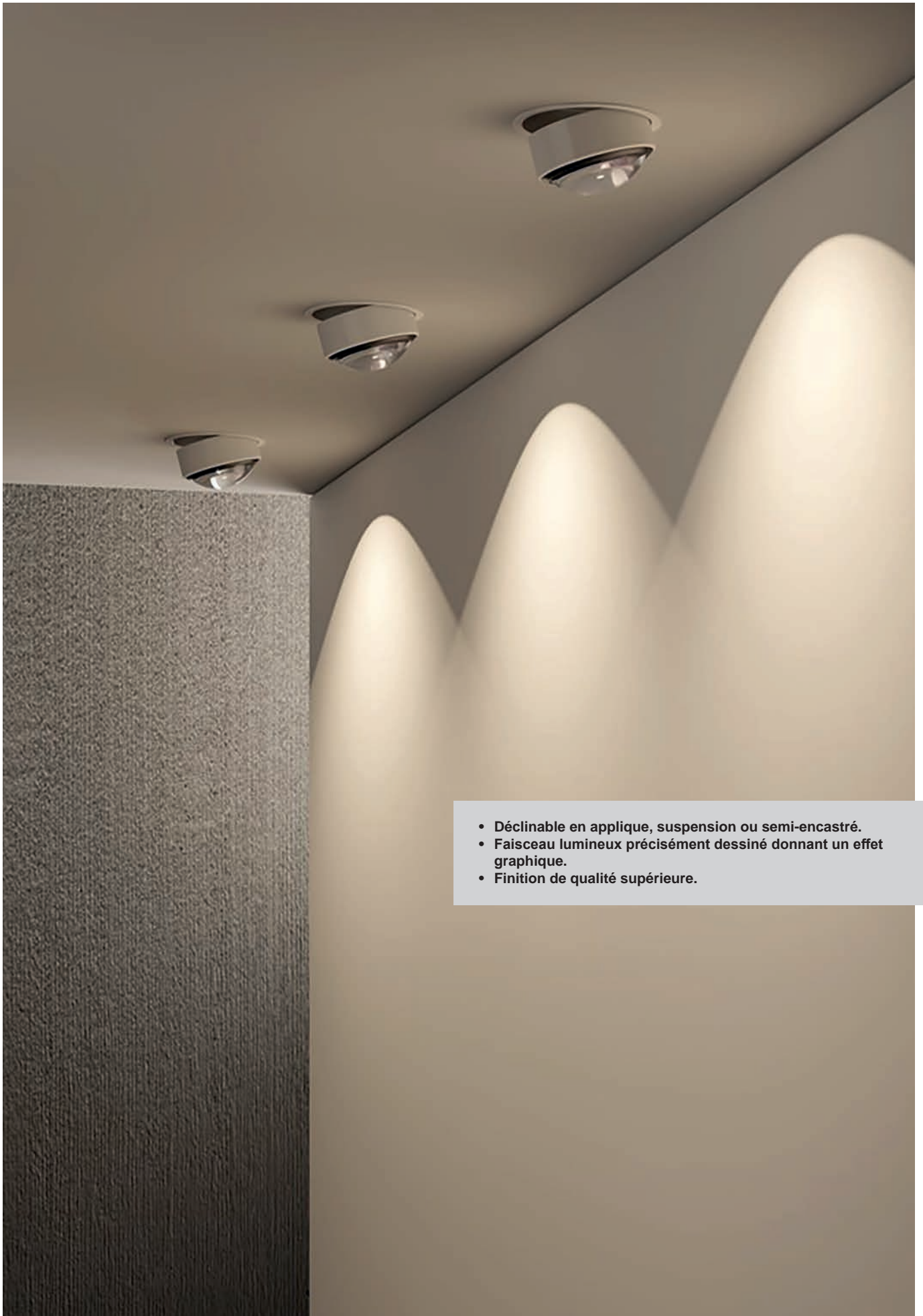

- Déclinable en applique, suspension ou semi-encastré.
- Faisceau lumineux précisément dessiné donnant un effet graphique.
- Finition de qualité supérieure.

EDDY RX

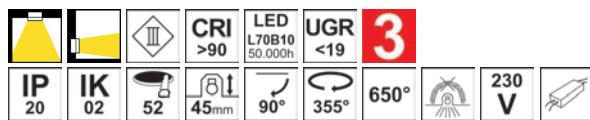

- Spot semi-encastré rond orientable.
- Fixation par ressorts.
- Convertisseur non dimmable déporté fourni.

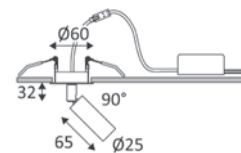

EDDY RX	COULEUR	MATIÈRE	P	T°	LED LUMEN	SYSTEM LUMEN	α	€
DO509WW05	■ NOIR MAT	ALUMINIUM	2W	3000K	205Lm	145Lm	24°	63,00
DO509WW30	■ BLANC MAT	ALUMINIUM	2W	3000K	205Lm	145Lm	24°	63,00



NOIR MAT



BLANC MAT





JOY RX

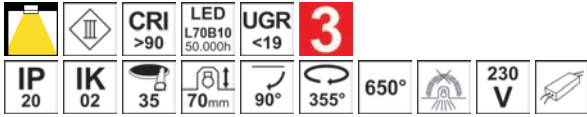

- Spot semi-encastré rond orientable.
- Fixation par ressorts.
- Convertisseur non dimmable déporté fourni.

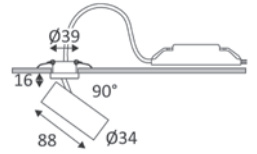

JOY RX	COULEUR	MATIÈRE	P	T°	LED LUMEN	SYSTEM LUMEN	α	€
DO510WW05	■ NOIR MAT	ALUMINIUM	4,5W	3000K	375Lm	260Lm	40°	97,00
DO510WW30	■ BLANC MAT	ALUMINIUM	4,5W	3000K	375Lm	260Lm	40°	97,00



NOIR MAT



BLANC MAT



FILI 1 RX-B

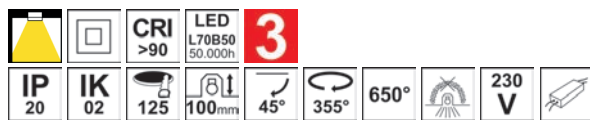

- Spot semi-encastré rond orientable.
- Fixation par lamelles.
- Convertisseur non dimmable déporté fourni.
- En option, convertisseur dimmable DALI-PUSH CD123 à commander séparément.

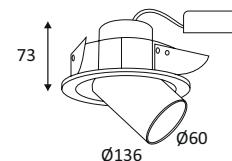

FILI 1 RX-B	COULEUR	MATIÈRE	P	T°	LED LUMEN	SYSTEM LUMEN	α	€
DO246WW05	■ NOIR MAT	ALUMINIUM	10W	3000K	1010Lm	650Lm	40°	165,00
DO246WW30	■ BLANC MAT	ALUMINIUM	10W	3000K	1010Lm	650Lm	40°	165,00
CONVERTISSEURS ET SOURCES			WATT MAX	€	DANS LA MÊME GAMME			
CD123	DRIVER 3-18W 250MA CC DIM DALI		3-18W	86,00		FILI 1 RX GU10 AUTO PAGE 86		



NOIR MAT



BLANC MAT

FILI 5 RDX-B

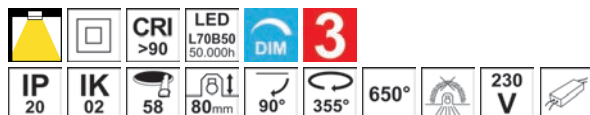

- Spot semi-encastré rond orientable.
- Fixation par lamelles.
- Livré avec réflecteur doré.
- Double bornier automatique.
- Convertisseur dimmable déporté fourni.
- Compatible avec variateur fin de phase.
- En option, convertisseur dimmable DALI-PUSH CD140 à commander séparément.

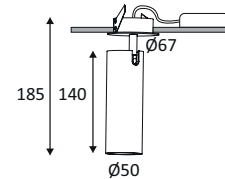

FILI 5 RDX-B	COULEUR	MATIÈRE	P	T°	LED LUMEN	SYSTEM LUMEN	α	€
DO490WW05	■ NOIR MAT	ALUMINIUM	14W	3000K	1120Lm	505Lm	40°	126,00
DO490WW30	■ BLANC MAT	ALUMINIUM	14W	3000K	1120Lm	505Lm	40°	126,00
CONVERTISSEURS ET SOURCES			WATT MAX	€	DANS LA MÊME GAMME			
CD140	DRIVER 3-18W 350MA CC DIM DALI		3-18W	99,00		FILI 5 RX-B GU10 AUTO PAGE 86		



NOIR MAT



BLANC MAT



DEAN RDX PLUS



- Spot semi-encastré rond orientable 3 en 1.
- 2700K, 3000K ou 4000K au choix via un interrupteur sur le convertisseur.
- Fixation par ressorts.
- Convertisseur dimmable déporté fourni.
- Compatible avec variateur fin de phase.

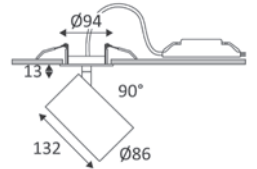

DEAN RDX PLUS	COULEUR	MATIÈRE	P	T°	LED LUMEN	SYSTEM LUMEN	α	€
DO52605	■ NOIR MAT	ALUMINIUM	28W	2700K 3000K 4000K	2300Lm (4000K)	1625Lm (4000K)	38°	182,00
DO52630	■ BLANC MAT	ALUMINIUM	28W	2700K 3000K 4000K	2300Lm (4000K)	1625Lm (4000K)	38°	182,00



NOIR MAT



BLANC MAT



KARL 1 RDX

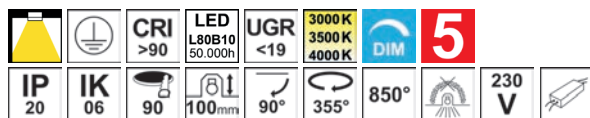

- Spot semi-encastré rond orientable 3 en 1.
- 3000K, 3500K ou 4000K au choix via un interrupteur à l'arrière du luminaire.
- Fixation par ressorts.
- Convertisseur dimmable déporté fourni.
- Compatible avec variateur fin de phase.

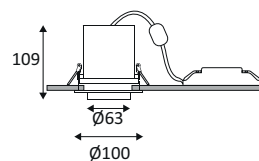

KARL 1 RDX	COULEUR	MATIÈRE	P	T°	LED LUMEN	SYSTEM LUMEN	α	€
DO54205	■ NOIR MAT	ALUMINIUM	13W	3000K 3500K 4000K	1330Lm (4000K)	960Lm (4000K)	38°	120,00
DO54230	■ BLANC MAT	ALUMINIUM	13W	3000K 3500K 4000K	1330Lm (4000K)	960Lm (4000K)	38°	120,00



NOIR MAT



BLANC MAT

KARL 2 RDX

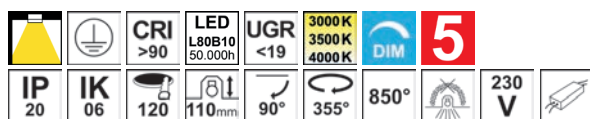

- Spot semi-encastré rond orientable 3 en 1.
- 3000K, 3500K ou 4000K au choix via un interrupteur à l'arrière du luminaire.
- Fixation par ressorts.
- Convertisseur dimmable déporté fourni.
- Compatible avec variateur fin de phase.

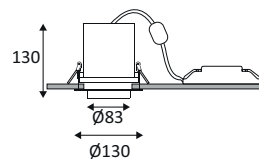

KARL 2 RDX	COULEUR	MATIÈRE	P	T°	LED LUMEN	SYSTEM LUMEN	α	€
DO54305	■ NOIR MAT	ALUMINIUM	26W	3000K 3500K 4000K	2750Lm (4000K)	2250Lm (4000K)	38°	158,00
DO54330	■ BLANC MAT	ALUMINIUM	26W	3000K 3500K 4000K	2750Lm (4000K)	2250Lm (4000K)	38°	158,00



NOIR MAT



BLANC MAT



KARL 1 RDX



INDIGO

LIGHTING



DOWNLIGHTS



DAX RD-230

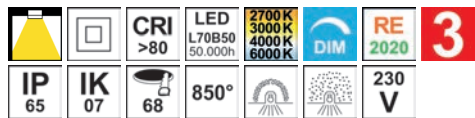

- Downlight encastré rond fixe 4 en 1.
- 2700K, 3000K, 4000K ou 6000K au choix via un interrupteur à l'arrière du luminaire.
- Fixation par ressorts.
- Peut être recouvert par un isolant déroulé ou soufflé.
- Double bornier automatique.
- Ne nécessite pas de convertisseur.
- Dimmable.
- Compatible avec variateur fin de phase.

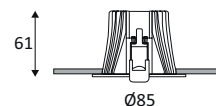

DAX RD-230	COULEUR	MATIÈRE	P	T°	LED LUMEN	SYSTEM LUMEN	α	€
DO48730	BLANC MAT	COMPOSITE	6W	2700K 3000K 4000K 6000K	850Lm (4000K)	675Lm (4000K)	100°	28,00

SENSO R-230

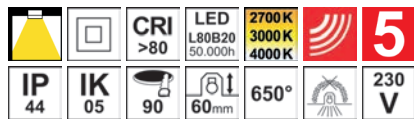

- Downlight encastré rond fixe 3 en 1.
- 2700K, 3000K ou 4000K au choix via un interrupteur à l'arrière du luminaire.
- Fixation par ressorts.
- Double bornier automatique.
- Avec détecteur IR 90°, zone de détection max. 5m de diamètre.
- Durée d'allumage de 3 minutes après détection.
- Fonctionne uniquement quand la luminosité est inférieure à 100 Lux.
- Ne nécessite pas de convertisseur.

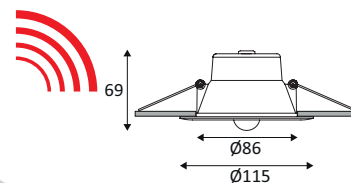

SENSO R-230	COULEUR	MATIÈRE	P	T°	LED LUMEN	SYSTEM LUMEN	α	€
DO53605	NOIR MAT	COMPOSITE	9W	2700K 3000K 4000K	1800Lm (4000K)	950Lm (4000K)	100°	44,00
DO53630	BLANC MAT	COMPOSITE	9W	2700K 3000K 4000K	1800Lm (4000K)	950Lm (4000K)	100°	42,00



NOIR MAT



BLANC MAT



DAX RD-230



TIGA 1 RD

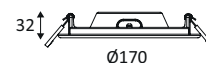
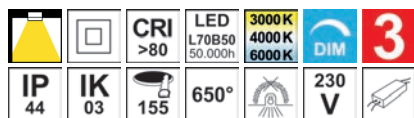

- Downlight encastré rond fixe 3 en 1.
- 3000K, 4000K ou 6000K au choix via un interrupteur à l'arrière du luminaire.
- Fixation par ressorts.
- Convertisseur dimmable intégré dans l'appareil.
- Compatible avec variateur fin de phase.



TIGA 1 RD	COULEUR	MATIÈRE	P	T°	LED LUMEN	SYSTEM LUMEN	α	€
DO35630	BLANC MAT	COMPOSITE	12W	3000K 4000K 6000K	1600Lm (4000K)	985Lm (4000K)	100°	42,00

TIGA 2 RD

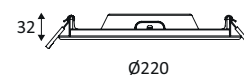
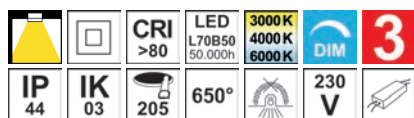

- Downlight encastré rond fixe 3 en 1.
- 3000K, 4000K ou 6000K au choix via un interrupteur à l'arrière du luminaire.
- Fixation par ressorts.
- Convertisseur dimmable intégré dans l'appareil.
- Compatible avec variateur fin de phase.



TIGA 2 RD	COULEUR	MATIÈRE	P	T°	LED LUMEN	SYSTEM LUMEN	α	€
DO35730	BLANC MAT	COMPOSITE	18W	3000K 4000K 6000K	2350Lm (4000K)	1625Lm (4000K)	100°	47,00



TIGA 3 RD

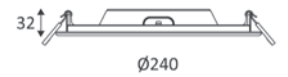
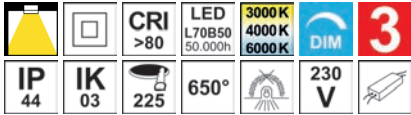

- Downlight encastré rond fixe 3 en 1.
- 3000K, 4000K ou 6000K au choix via un interrupteur à l'arrière du luminaire.
- Fixation par ressorts.
- Convertisseur dimmable intégré dans l'appareil.
- Compatible avec variateur fin de phase.

TIGA 3 RD	COULEUR	MATIÈRE	P	T°	LED LUMEN	SYSTEM LUMEN	α	€
DO35830	BLANC MAT	COMPOSITE	24W	3000K 4000K 6000K	2870Lm (4000K)	2085Lm (4000K)	100°	53,00



TIGA 2 RD

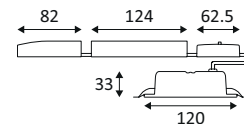
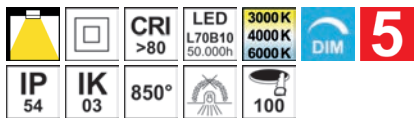

THEA LITE CSP 1



- Downlight encastré rond fixe 3 en 1.
- 3000K, 4000K ou 6000K au choix via un interrupteur à l'arrière du luminaire.
- Fixation par ressorts.
- Double bornier automatique.
- Connecteur Plug & Play inclus.
- Convertisseur dimmable coupure de phase déporté fourni ou convertisseur dimmable DALI, Push-Dim et 0-10V à commander séparément.
- Kit d'éclairage de secours en option.

THEA LITE CSP 1	COULEUR	MATIÈRE	P	T°	LED LUMEN	SYSTEM LUMEN	α	€
CONVERTISSEUR EXCLU								
THL1X	BLANC	ALUMINIUM	10W	3000K 4000K 6000K	1600Lm (4000K)	1200Lm (4000K)	80°	28,00
CONVERTISSEUR INCLUS								
THL1T	NEW BLANC	ALUMINIUM	10W	3000K 4000K 6000K	1600Lm (4000K)	1200Lm (4000K)	80°	35,00
ACCESSOIRES	DESCRIPTION	L(MM)						€
LEDEP10	KIT ECLAIRAGE DE SECOURS	199						221,00
CONVERTISSEURS ET SOURCES			WATT MAX	€				
PS250600MA	DRIVER 13-29W 250-600MA CC DALI PUSH-DIM 0-10V			13-29W	74,00			





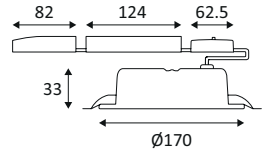
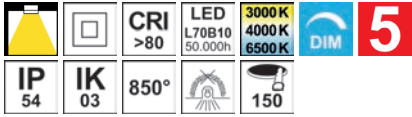

THEA LITE CSP 2



- Downlight encastré rond fixe 3 en 1.
- 3000K, 4000K ou 6500K au choix via un interrupteur à l'arrière du luminaire.
- Fixation par ressorts.
- Double bornier automatique.
- Connecteur Plug & Play inclus.
- Convertisseur dimmable coupure de phase déporté fourni ou convertisseur dimmable DALI, Push-Dim et 0-10V à commander séparément.
- Kit d'éclairage de secours en option.

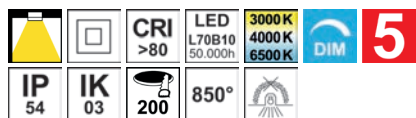

THEA LITE CSP 2	COULEUR	MATIÈRE	P	T°	LED LUMEN	SYSTEM LUMEN	α	€
CONVERTISSEUR EXCLU								
THL2X	BLANC	ALUMINIUM	14W	3000K 4000K 6500K	2000Lm (4000K)	1680Lm (4000K)	90°	36,00
CONVERTISSEUR INCLUS								
THL2T	NEW BLANC	ALUMINIUM	14W	3000K 4000K 6500K	2000Lm (4000K)	1680Lm (4000K)	90°	45,00
ACCESSOIRES	DESCRIPTION		L(MM)					€
LEDEP10	KIT ECLAIRAGE DE SECOURS		199					221,00
CONVERTISSEURS ET SOURCES			WATT MAX					€
PS250600MA	DRIVER 13-29W 250-600MA CC DALI PUSH-DIM 0-10V			13-29W				74,00

THEA LITE CSP 3

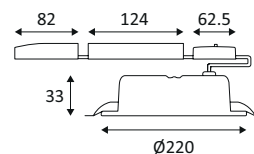

- Downlight encastré rond fixe 3 en 1.
- 3000K, 4000K ou 6500K au choix via un interrupteur à l'arrière du luminaire.
- Fixation par ressorts.
- Double bornier automatique.
- Connecteur Plug & Play inclus.
- Convertisseur dimmable coupure de phase déporté fourni ou convertisseur dimmable DALI, Push-Dim et 0-10V à commander séparément.
- Kit d'éclairage de secours en option.
- Bague couvrant un diamètre de perçage de 240 à 290mm à commander séparément.



THEA LITE CSP 3	COULEUR	MATIÈRE	P	T°	LED LUMEN	SYSTEM LUMEN	α	€
CONVERTISSEUR EXCLU								
THL3X	BLANC	ALUMINIUM	20W	3000K 4000K 6500K	2950Lm (4000K)	2400Lm (4000K)	90°	43,00
CONVERTISSEUR INCLUS								
THL3T	NEW BLANC	ALUMINIUM	20W	3000K 4000K 6500K	2950Lm (4000K)	2400Lm (4000K)	90°	60,00
ACCESSOIRES	COULEUR	MATIÈRE	DESCRIPTION		L(MM)			€
DL801MW	NEW BLANC	ACIER	BAGUE DE MONTAGE 319MM					26,00
LEDEP10			KIT ECLAIRAGE DE SECOURS		199			221,00
CONVERTISSEURS ET SOURCES			WATT MAX		€			
PS250600MA	DRIVER 13-29W 250-600MA CC DALI PUSH-DIM 0-10V			13-29W	74,00			



FOX 2 RD

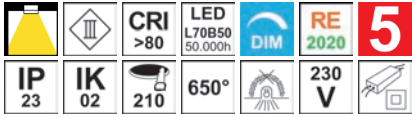

- Downlight encastré rond fixe.
- Fixation par ressorts.
- Convertisseur dimmable déporté fourni.
- Compatible avec variateur fin de phase.



FOX 2 RD	COULEUR	MATIÈRE	P	T°	LED LUMEN	SYSTEM LUMEN	α	€
DO102WW05	NOIR MAT	FONTE D'ALUMINIUM	19W	3000K	2700Lm	1725Lm	110°	80,00
DO102WW30	BLANC MAT	FONTE D'ALUMINIUM	19W	3000K	2700Lm	1725Lm	110°	80,00
DO102NW05	NOIR MAT	FONTE D'ALUMINIUM	19W	4000K	2800Lm	1805Lm	110°	80,00
DO102NW30	BLANC MAT	FONTE D'ALUMINIUM	19W	4000K	2800Lm	1805Lm	110°	80,00



NOIR MAT

BLANC MAT

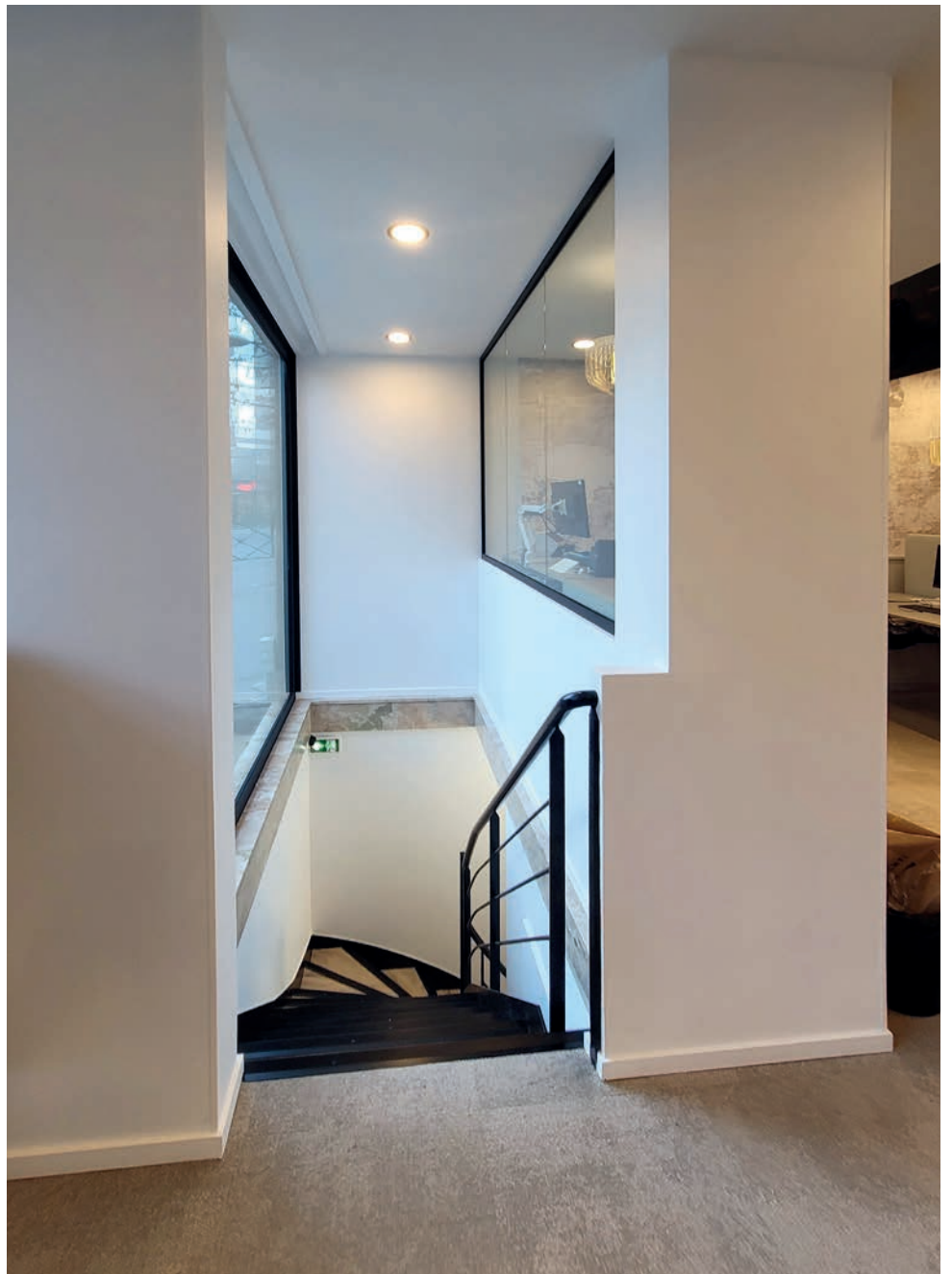

AL1016 RX



- Downlight encastré rond orientable.
- Fixation par ressorts.
- Convertisseur non dimmable déporté fourni.
- En option, convertisseur dimmable DALI, Push-Dim et 1-10V à commander séparément.

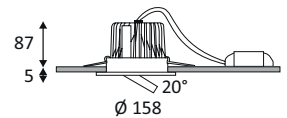

AL1016 RX	COULEUR	MATIÈRE	P	T°	LED LUMEN	SYSTEM LUMEN	α	€
DO107WW30	BLANC MAT	FORTE D'ALUMINIUM	26W	3000K	2350Lm	2050Lm	30°	213,00
DO107NW30	BLANC MAT	FORTE D'ALUMINIUM	26W	4000K	2450Lm	2140Lm	30°	213,00
CONVERTISSEURS ET SOURCES			WATT MAX	€				
PSDAL700M	DRIVER 3-50W 700MA CC DIM 1-10V DALI PUSH		3-50W	146,00				





THEA PRO 1

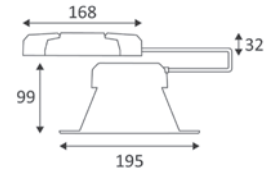
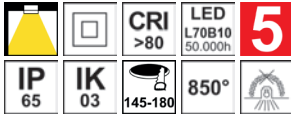

- Downlight encastré rond fixe.
- Diffuseur en polycarbonate opalin.
- Réflecteur basse luminance.
- Réflecteur pour UGR<19 en option.
- Fixation par ressorts.
- Peut être recouvert par un isolant, à l'exception du convertisseur.
- Double bornier automatique.
- Connecteur Plug & Play inclus.
- Convertisseur non dimmable déporté fourni ou convertisseur à commander séparément.
- Convertisseur dimmable DALI / Push-Dim en option.
- Kit d'éclairage de secours en option.

THEA PRO 1	COULEUR	MATIÈRE	P	T°	LED LUMEN	SYSTEM LUMEN	α	€
CONVERTISSEUR EXCLU								
THP2X	BLANC	ALUMINIUM + THERMOPLASTIQUE	14W	4000K	2400Lm	2000Lm	80°	50,00
CONVERTISSEUR INCLUS								
THP2N	BLANC	ALUMINIUM + THERMOPLASTIQUE	14W	4000K	2400Lm	2000Lm	80°	55,00
ACCESSOIRES	DESCRIPTION	L(MM)						€
LEDEP10	KIT ECLAIRAGE DE SECOURS	199						221,00
THP12UGR	REFLECTEUR UGR<19 THP2							17,00
CONVERTISSEURS ET SOURCES								€
THP23DD	DRIVER DALI PUSH-DIM THP2	44,00						



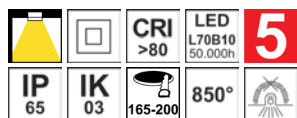

THEA PRO 2

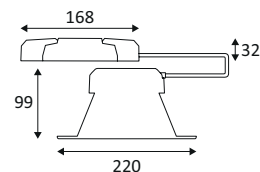

- Downlight encastré rond fixe.
- Diffuseur en polycarbonate opalin.
- Réflecteur basse luminance.
- Réflecteur pour UGR<19 en option.
- Fixation par ressorts.
- Peut être recouvert par un isolant, à l'exception du convertisseur.
- Double bornier automatique.
- Connecteur Plug & Play inclus.
- Convertisseur non dimmable déporté fourni ou convertisseur à commander séparément.
- Convertisseur dimmable DALI / Push-Dim en option.
- Kit d'éclairage de secours en option.
- Bague couvrant un diamètre de perçage de 240 à 290mm à commander séparément.



THEA PRO 2	COULEUR	MATIÈRE	P	T°	LED LUMEN	SYSTEM LUMEN	α	€
CONVERTISSEUR EXCLU								
THP4X	BLANC	ALUMINIUM + THERMOPLASTIQUE	25W	4000K	4400Lm	3500Lm	80°	64,00
CONVERTISSEUR INCLUS								
THP4N	BLANC	ALUMINIUM + THERMOPLASTIQUE	25W	4000K	4400Lm	3500Lm	80°	68,00
ACCESSOIRES	COULEUR	MATIÈRE	DESCRIPTION			L(MM)	€	
DL801MW	NEW BLANC	ACIER	BAGUE DE MONTAGE 319MM				26,00	
LEDEP10			KIT ECLAIRAGE DE SECOURS			199		221,00
THP34UGR			REFLECTEUR UGR<19 THP4					21,00
CONVERTISSEURS ET SOURCES								€
THP4DD	DRIVER DALI PUSH-DIM THP4							44,00



LYON 1 R

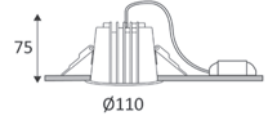
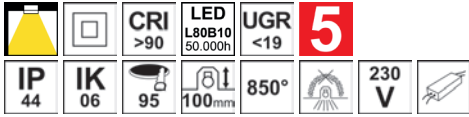

- Downlight encastré rond fixe.
- Réflecteur basse luminance.
- Fixation par ressorts.
- Convertisseur non-dimmable ou dimmable DALI-push déporté fourni.

LYON 1 R	COULEUR	MATIÈRE	P	T°	LED LUMEN	SYSTEM LUMEN	α	€
NON DIMMABLE								
DO538WW05	■ NOIR MAT	ALUMINIUM	15W	3000K	1875Lm	1515Lm	60°	70,00
DO538WW17	▣ NOIR MAT - ARGENT	ALUMINIUM	15W	3000K	1875Lm	1590Lm	60°	70,00
DO538WW30	■ BLANC MAT	ALUMINIUM	15W	3000K	1875Lm	1590Lm	60°	70,00
DO538WW53	▣ BLANC MAT - ARGENT	ALUMINIUM	15W	3000K	1875Lm	1590Lm	60°	70,00
DO538NW05	■ NOIR MAT	ALUMINIUM	15W	4000K	1920Lm	1545Lm	60°	70,00
DO538NW17	▣ NOIR MAT - ARGENT	ALUMINIUM	15W	4000K	1920Lm	1625Lm	60°	70,00
DO538NW30	■ BLANC MAT	ALUMINIUM	15W	4000K	1920Lm	1625Lm	60°	70,00
DO538NW53	▣ BLANC MAT - ARGENT	ALUMINIUM	15W	4000K	1920Lm	1625Lm	60°	70,00
DIMMABLE DALI								
DO538WW05DA	■ NOIR MAT	ALUMINIUM	15W	3000K	1875Lm	1515Lm	60°	116,00
DO538WW17DA	▣ NOIR MAT - ARGENT	ALUMINIUM	15W	3000K	1875Lm	1590Lm	60°	145,00
DO538WW30DA	■ BLANC MAT	ALUMINIUM	15W	3000K	1875Lm	1590Lm	60°	116,00
DO538WW53DA	▣ BLANC MAT - ARGENT	ALUMINIUM	15W	3000K	1875Lm	1590Lm	60°	116,00
DO538NW05DA	■ NOIR MAT	ALUMINIUM	15W	4000K	1920Lm	1545Lm	60°	116,00
DO538NW17DA	▣ NOIR MAT - ARGENT	ALUMINIUM	15W	4000K	1920Lm	1625Lm	60°	145,00
DO538NW30DA	■ BLANC MAT	ALUMINIUM	15W	4000K	1920Lm	1625Lm	60°	116,00
DO538NW53DA	▣ BLANC MAT - ARGENT	ALUMINIUM	15W	4000K	1920Lm	1625Lm	60°	116,00



NOIR MAT



NOIR MAT - ARGENT



BLANC MAT



BLANC MAT - ARGENT



LYON 2 R

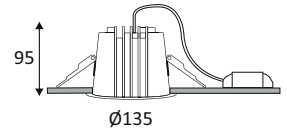
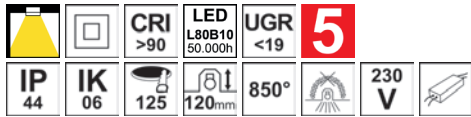

- Downlight encastré rond fixe.
- Réflecteur basse luminance.
- Fixation par ressorts.
- Convertisseur non-dimmable ou dimmable DALI-push déporté fourni.

LYON 2 R	COULEUR	MATIÈRE	P	T°	LED LUMEN	SYSTEM LUMEN	α	€
NON DIMMABLE								
DO539WW05	■ NOIR MAT	ALUMINIUM	25W	3000K	3000Lm	2535Lm	60°	96,00
DO539WW17	▣ NOIR MAT - ARGENT	ALUMINIUM	25W	3000K	3000Lm	2670Lm	60°	96,00
DO539WW30	□ BLANC MAT	ALUMINIUM	25W	3000K	3000Lm	2670Lm	60°	96,00
DO539WW53	▤ BLANC MAT - ARGENT	ALUMINIUM	25W	3000K	3000Lm	2670Lm	60°	96,00
DO539NW05	■ NOIR MAT	ALUMINIUM	25W	4000K	3070Lm	2590Lm	60°	96,00
DO539NW17	▣ NOIR MAT - ARGENT	ALUMINIUM	25W	4000K	3070Lm	2750Lm	60°	96,00
DO539NW30	□ BLANC MAT	ALUMINIUM	25W	4000K	3070Lm	2750Lm	60°	96,00
DO539NW53	▤ BLANC MAT - ARGENT	ALUMINIUM	25W	4000K	3070Lm	2750Lm	60°	96,00
DIMMABLE DALI								
DO539WW05DA	■ NOIR MAT	ALUMINIUM	25W	3000K	3000Lm	2535Lm	60°	140,00
DO539WW17DA	▣ NOIR MAT - ARGENT	ALUMINIUM	25W	3000K	3000Lm	2670Lm	60°	175,00
DO539WW30DA	□ BLANC MAT	ALUMINIUM	25W	3000K	3000Lm	2670Lm	60°	140,00
DO539WW53DA	▤ BLANC MAT - ARGENT	ALUMINIUM	25W	3000K	3000Lm	2670Lm	60°	140,00
DO539NW05DA	■ NOIR MAT	ALUMINIUM	25W	4000K	3070Lm	2590Lm	60°	140,00
DO539NW17DA	▣ NOIR MAT - ARGENT	ALUMINIUM	25W	4000K	3070Lm	2750Lm	60°	140,00
DO539NW30DA	□ BLANC MAT	ALUMINIUM	25W	4000K	3070Lm	2750Lm	60°	140,00
DO539NW53DA	▤ BLANC MAT - ARGENT	ALUMINIUM	25W	4000K	3070Lm	2750Lm	60°	140,00





LYON 3 R

IP 44	IK 06	150	CRI >90	LED L80B10 50.000h	UGR <19	5	850°	230 V	

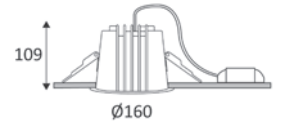

- Downlight encastré rond fixe.
- Réflecteur basse luminance.
- Fixation par ressorts.
- Convertisseur non-dimmable ou dimmable DALI-push déporté fourni.

LYON 3 R	COULEUR	MATIÈRE	P	T°	LED LUMEN	SYSTEM LUMEN	α	€
NON DIMMABLE								
DO540WW05	■ NOIR MAT	ALUMINIUM	30W	3000K	4000Lm	3020Lm	60°	118,00
DO540WW17	▣ NOIR MAT - ARGENT	ALUMINIUM	30W	3000K	4000Lm	3180Lm	60°	118,00
DO540WW30	□ BLANC MAT	ALUMINIUM	30W	3000K	4000Lm	3180Lm	60°	118,00
DO540WW53	▤ BLANC MAT - ARGENT	ALUMINIUM	30W	3000K	4000Lm	3180Lm	60°	118,00
DO540NW05	■ NOIR MAT	ALUMINIUM	30W	4000K	4100Lm	3085Lm	60°	118,00
DO540NW17	▣ NOIR MAT - ARGENT	ALUMINIUM	30W	4000K	4100Lm	3275Lm	60°	118,00
DO540NW30	□ BLANC MAT	ALUMINIUM	30W	4000K	4100Lm	3275Lm	60°	118,00
DO540NW53	▤ BLANC MAT - ARGENT	ALUMINIUM	30W	4000K	4100Lm	3275Lm	60°	118,00
DIMMABLE DALI								
DO540WW05DA	■ NOIR MAT	ALUMINIUM	30W	3000K	4000Lm	3020Lm	60°	179,00
DO540WW17DA	▣ NOIR MAT - ARGENT	ALUMINIUM	30W	3000K	4000Lm	3180Lm	60°	224,00
DO540WW30DA	□ BLANC MAT	ALUMINIUM	30W	3000K	4000Lm	3180Lm	60°	179,00
DO540WW53DA	▤ BLANC MAT - ARGENT	ALUMINIUM	30W	3000K	4000Lm	3180Lm	60°	179,00
DO540NW05DA	■ NOIR MAT	ALUMINIUM	30W	4000K	4100Lm	3085Lm	60°	179,00
DO540NW17DA	▣ NOIR MAT - ARGENT	ALUMINIUM	30W	4000K	4100Lm	3275Lm	60°	224,00
DO540NW30DA	□ BLANC MAT	ALUMINIUM	30W	4000K	4100Lm	3275Lm	60°	179,00
DO540NW53DA	▤ BLANC MAT - ARGENT	ALUMINIUM	30W	4000K	4100Lm	3275Lm	60°	179,00



NOIR MAT NOIR MAT - ARGENT BLANC MAT BLANC MAT - ARGENT

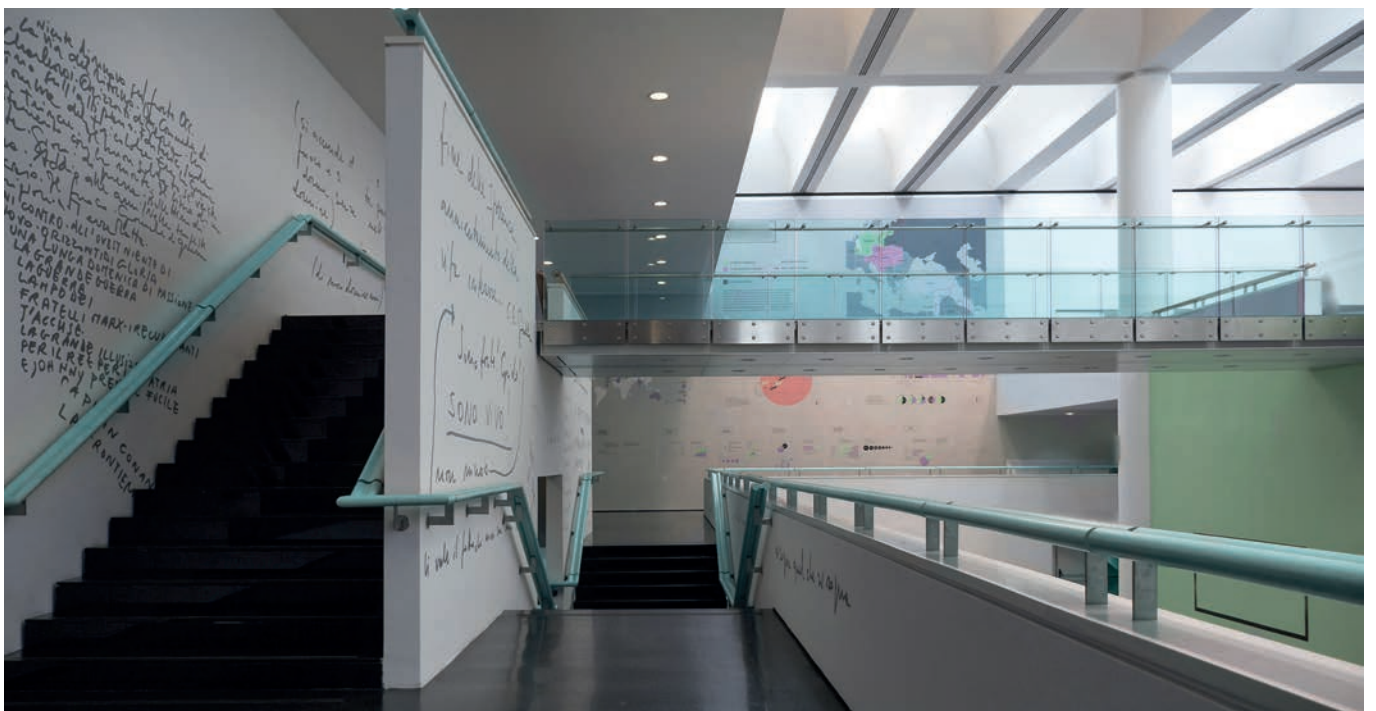

LYON 4 R



- Downlight encastré rond fixe.
- Réflecteur basse luminance.
- Fixation par ressorts.
- Convertisseur non-dimmable ou dimmable DALI-push déporté fourni.

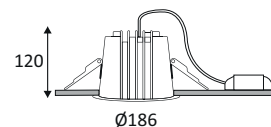

LYON 4 R	COULEUR	MATIÈRE	P	T°	LED LUMEN	SYSTEM LUMEN	α	€
NON DIMMABLE								
DO541WW05	■ NOIR MAT	ALUMINIUM	40W	3000K	5000Lm	3835Lm	60°	133,00
DO541WW17	▣ NOIR MAT - ARGENT	ALUMINIUM	40W	3000K	5000Lm	4035Lm	60°	133,00
DO541WW30	□ BLANC MAT	ALUMINIUM	40W	3000K	5000Lm	4035Lm	60°	133,00
DO541WW53	▤ BLANC MAT - ARGENT	ALUMINIUM	40W	3000K	5000Lm	4035Lm	60°	133,00
DO541NW05	■ NOIR MAT	ALUMINIUM	40W	4000K	5120Lm	3915Lm	60°	133,00
DO541NW17	▣ NOIR MAT - ARGENT	ALUMINIUM	40W	4000K	5120Lm	4160Lm	60°	133,00
DO541NW30	□ BLANC MAT	ALUMINIUM	40W	4000K	5120Lm	4160Lm	60°	133,00
DO541NW53	▤ BLANC MAT - ARGENT	ALUMINIUM	40W	4000K	5120Lm	4160Lm	60°	133,00
DIMMABLE DALI								
DO541WW05DA	■ NOIR MAT	ALUMINIUM	40W	3000K	5000Lm	3835Lm	60°	192,00
DO541WW17DA	▣ NOIR MAT - ARGENT	ALUMINIUM	40W	3000K	5000Lm	4035Lm	60°	240,00
DO541WW30DA	□ BLANC MAT	ALUMINIUM	40W	3000K	5000Lm	4035Lm	60°	240,00
DO541WW53DA	▤ BLANC MAT - ARGENT	ALUMINIUM	40W	3000K	5000Lm	4035Lm	60°	240,00
DO541NW05DA	■ NOIR MAT	ALUMINIUM	40W	4000K	5120Lm	3915Lm	60°	240,00
DO541NW17DA	▣ NOIR MAT - ARGENT	ALUMINIUM	40W	4000K	5120Lm	4160Lm	60°	192,00
DO541NW30DA	□ BLANC MAT	ALUMINIUM	40W	4000K	5120Lm	4160Lm	60°	192,00
DO541NW53DA	▤ BLANC MAT - ARGENT	ALUMINIUM	40W	4000K	5120Lm	4160Lm	60°	240,00



NOIR MAT

NOIR MAT - ARGENT

BLANC MAT

BLANC MAT - ARGENT

LYON 4 R



IZA 1 SDX

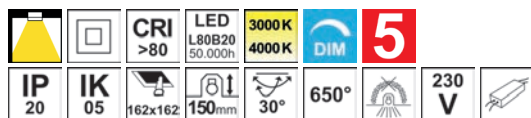

- Downlight encastré carré orientable 2 en 1.
- 3000K ou 4000K au choix via un interrupteur à l'arrière du luminaire.
- Fixation par ressorts.
- Convertisseur dimmable déporté fourni.
- Compatible avec variateur début et fin de phase.

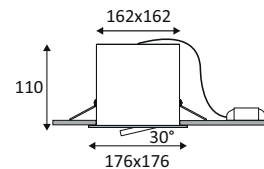

IZA 1 SDX	COULEUR	MATIÈRE	P	T°	L(MM)	LED LUMEN	SYSTEM LUMEN	α	€
DO53105	■ NOIR MAT	ALUMINIUM	24W	3000K 4000K	176	3360Lm (4000K)	2645Lm (4000K)	60°	155,00
DO53130	■ BLANC MAT	ALUMINIUM	24W	3000K 4000K	176	3360Lm (4000K)	2645Lm (4000K)	60°	155,00



NOIR MAT

BLANC MAT

IZA 2 SDX

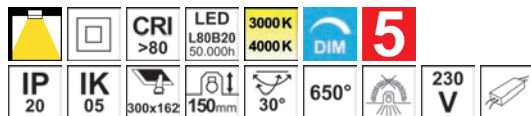

- Downlight encastré rectangulaire orientable 2 en 1.
- 3000K ou 4000K au choix via un interrupteur à l'arrière du luminaire.
- Fixation par ressorts.
- Convertisseurs dimmables déportés fournis.
- Compatible avec variateur début et fin de phase.

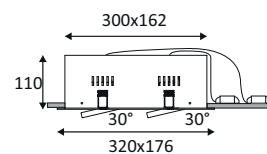

IZA 2 SDX	COULEUR	MATIÈRE	P	T°	L(MM)	LED LUMEN	SYSTEM LUMEN	α	€
DO53205	■ NOIR MAT	ALUMINIUM	48W	3000K 4000K	320	3360Lm (4000K)	5315Lm (4000K)	60°	274,00
DO53230	■ BLANC MAT	ALUMINIUM	48W	3000K 4000K	320	3360Lm (4000K)	5315Lm (4000K)	60°	274,00



NOIR MAT

BLANC MAT



IZA 2 SDX



SPIRA 1 RX PLUS



- Downlight encastré rond orientable 3 en 1.
- 2700K, 3000K ou 4000K au choix via un interrupteur sur le convertisseur.
- Verre de protection.
- Fixation par ressorts.
- Convertisseur non dimmable déporté fourni.
- Bague couvrant un diamètre de perçage de 220 à 240mm à commander séparément.

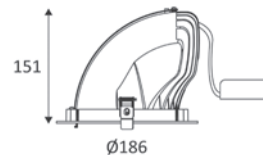

SPIRA 1 RX PLUS	COULEUR	MATIÈRE	P	T°	LED LUMEN	SYSTEM LUMEN	α	€
DO48805	NOIR	FONTE D'ALUMINIUM	40W	2700K 3000K 4000K	4600Lm (4000K)	3325Lm (4000K)	40°	158,00
DO48804	BLANC	FONTE D'ALUMINIUM	40W	2700K 3000K 4000K	4600Lm (4000K)	3610Lm (4000K)	40°	158,00
ACCESSOIRES	COULEUR	MATIÈRE	DESCRIPTION					€
DO54804	BLANC	ALUMINIUM	BAGUE DE FINITION 250MM					20,00
DO54805	NOIR	ALUMINIUM	BAGUE DE FINITION 250MM					20,00



NOIR



BLANC





SPIRA 3 RX

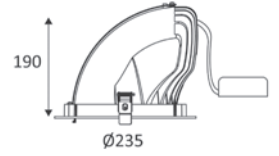
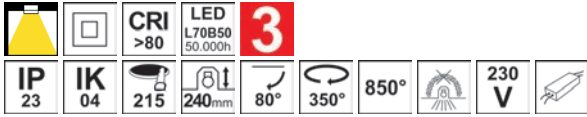

- Downlight encastré rond orientable.
- Verre de protection.
- Fixation par ressorts.
- Convertisseur non dimmable déporté fourni.

SPIRA 3 RX	COULEUR	MATIÈRE	P	T°	LED LUMEN	SYSTEM LUMEN	α	€
DO344NW04	BLANC	FRONT D'ALUMINIUM	60W	4000K	8680Lm	7125Lm	40°	308,00



FOCEA 1 SX PLUS

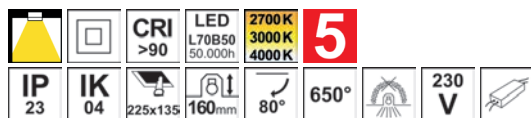

- Downlight encastré rectangulaire orientable 3 en 1.
- 2700K, 3000K ou 4000K au choix via un interrupteur sur le convertisseur.
- Verre de protection.
- Fixation par ressorts.
- Convertisseur non dimmable déporté fourni.

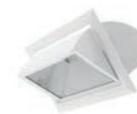
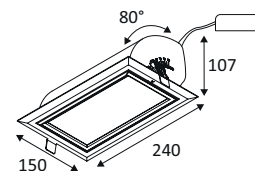

FOCEA 1 SX PLUS	COULEUR	MATIÈRE	P	T°	L(MM)	LED LUMEN	SYSTEM LUMEN	α	€
DO48905	■ NOIR	FONTE D'ALUMINIUM	40W	2700K 3000K 4000K	240	3400Lm (4000K)	2305Lm (4000K)	60°	183,00
DO48904	■ BLANC	FONTE D'ALUMINIUM	40W	2700K 3000K 4000K	240	4600Lm (4000K)	3620Lm (4000K)	60°	183,00



NOIR



BLANC

FOCEA 2 SX



- Downlight encastré rectangulaire orientable.
- Verre de protection.
- Fixation par ressorts.
- Convertisseur non dimmable déporté fourni.

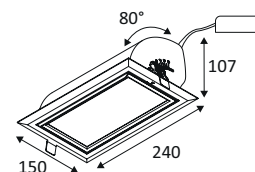

FOCEA 2 SX	COULEUR	MATIÈRE	P	T°	L(MM)	LED LUMEN	SYSTEM LUMEN	α	€
DO346NW04	■ BLANC	FONTE D'ALUMINIUM	60W	4000K	240	8400Lm	6645Lm	60°	295,00



FOCEA 1 SX PLUS



INDIGO

LIGHTING



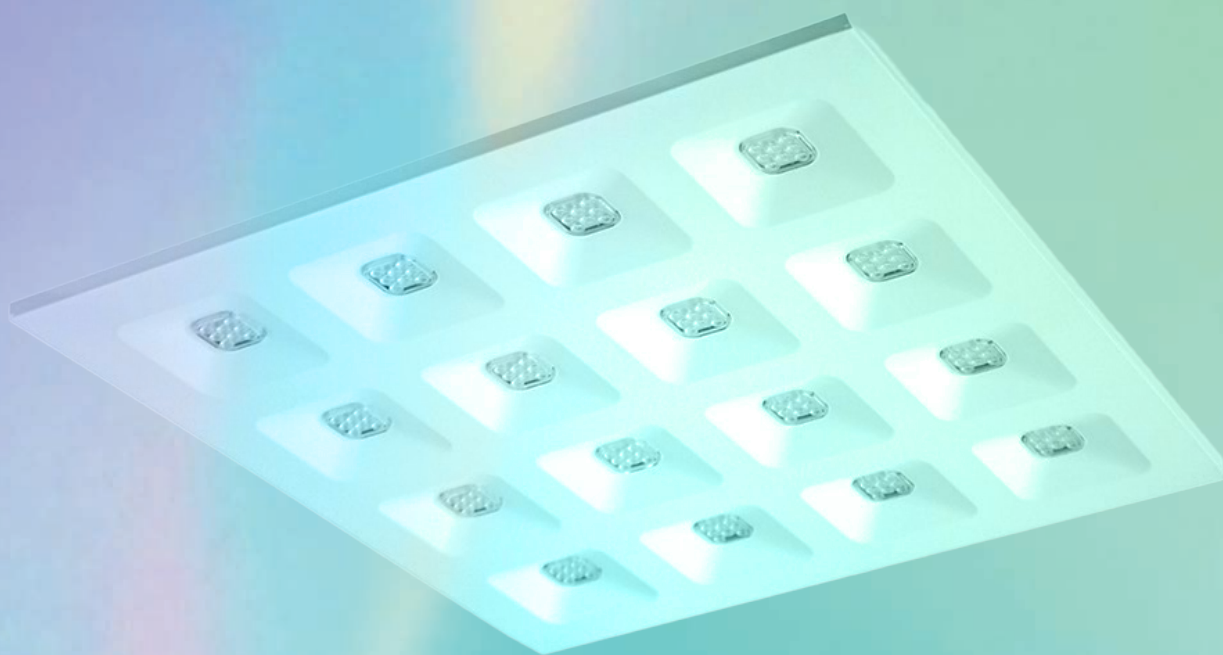

DALLES LED

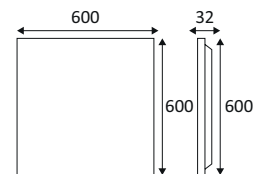

SOLIS 1



- Dalle LED 600x600mm.
- Diffuseur PS à structure prismatique.
- UGR<16 (P2A16) ou UGR<19 (P2A19).
- Connecteur rapide et filin de sécurité (1m) inclus.
- Peut être recouvert par un isolant, à l'exception du convertisseur.
- Convertisseur non dimmable déporté fourni ou convertisseur à commander séparément.
- Convertisseur dimmable DALI, Push-Dim et 0-10V en option.
- Kit de montage en saillie ou kit de suspension à commander séparément.
- Kit d'éclairage de secours en option.

SOLIS 1	COULEUR	MATIÈRE	P	T°	L(MM)	LED LUMEN	SYSTEM LUMEN	α	€
CONVERTISSEUR EXCLU									
P2A16X30WA	BLANC	ALUMINIUM	30W	4000K	600	4125Lm	3450Lm	90°	50,00
P2A19X40WA	BLANC	ALUMINIUM	40W	4000K	600	5500Lm	4600Lm	90°	59,00
CONVERTISSEUR INCLUS									
P2A19S30WW	NEW BLANC	ALUMINIUM	30W	3000K	600	3600Lm	3125Lm	90°	54,00
P2A16S30WA	BLANC	ALUMINIUM	30W	4000K	600	4125Lm	3450Lm	90°	54,00
P2A19S40WA	BLANC	ALUMINIUM	40W	4000K	600	5500Lm	4600Lm	90°	74,00
ACCESSOIRES									
ACCESSOIRES	COULEUR	MATIÈRE	DESCRIPTION			L(MM)	€		
AU4/66	NEW BLANC MAT	ALUMINIUM	CADRE DE MONTAGE EN SAILLIE POUR DALLES 600X600MM			600	65,00		
AU4/66/LINK	NEW BLANC MAT	ALUMINIUM	MODULE DE LIAISON 600MM POUR CADRE DE MONTAGE EN SAILLIE			600	45,00		
AZ7	NEW BLANC MAT	INOX	KIT DE SUSPENSION L:1000MM				30,00		
LEDEP10			KIT ECLAIRAGE DE SECOURS			199		221,00	
CONVERTISSEURS ET SOURCES									
			WATT MAX	€					
PS6501100MA	DRIVER 40W 650-1100MA CC DALI PUSH-DIM 0-10V			40W	60,00				





SOLIS PRO

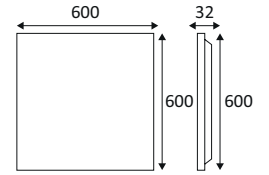
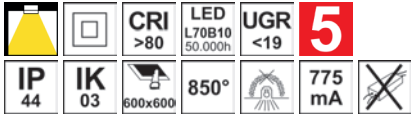

- Dalle LED 600x600mm.
- Diffuseur PS à structure prismatique.
- Connecteur rapide et filin de sécurité inclus.
- Peut être recouvert par un isolant, à l'exception du convertisseur.
- Convertisseur dimmable DALI, Push-Dim et 0-10V à commander séparément.
- Kit de montage en saillie ou kit de suspension à commander séparément.
- Kit d'éclairage de secours en option.

SOLIS PRO	COULEUR	MATIÈRE	P	T°	L(MM)	LED LUMEN	SYSTEM LUMEN	α	€
SOLP66X4K	BLANC	ALUMINIUM	28W	4000K	600	5400Lm	4480Lm	90°	113,00
ACCESSOIRES	COULEUR	MATIÈRE	DESCRIPTION			L(MM)	€		
AU4/66	NEW BLANC MAT	ALUMINIUM	CADRE DE MONTAGE EN SAILLIE POUR DALLES 600X600MM			600	65,00		
AU4/66/LINK	NEW BLANC MAT	ALUMINIUM	MODULE DE LIAISON 600MM POUR CADRE DE MONTAGE EN SAILLIE			600	45,00		
AZ7	NEW BLANC MAT	INOX	KIT DE SUSPENSION L:1000MM				30,00		
LEDEP10			KIT ECLAIRAGE DE SECOURS			199		221,00	
CONVERTISSEURS ET SOURCES					WATT MAX	€			
PS6501100MA	DRIVER 40W 650-1100MA CC DALI PUSH-DIM 0-10V			40W	60,00				

SOLIS PRO CSP

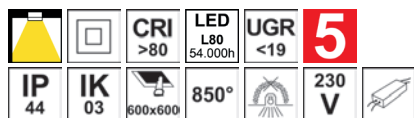

- Dalle LED 600x600mm.
- Diffuseur PS à structure prismatique.
- Connecteur rapide et filin de sécurité inclus.
- Peut être recouvert par un isolant, à l'exception du convertisseur.
- Convertisseur non dimmable déporté fourni.
- Multi-puissance : 22, 24, 26 ou 28W au choix via un interrupteur sur le convertisseur.
- Kit de montage en saillie ou kit de suspension à commander séparément.
- Kit d'éclairage de secours en option.

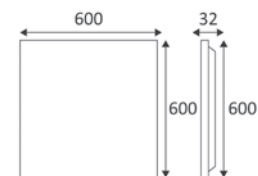

SOLIS PRO CSP	COULEUR	MATIÈRE	LED	T°	SYSTEM LUMEN	L(MM)	α	€
SOLP66N4K	BLANC	ALUMINIUM	22W 24W 26W 28W	4000K	3520 Lm 3840 Lm 4160 Lm 4480 Lm	600	90°	111,00
ACCESSOIRES	COULEUR	MATIÈRE	DESCRIPTION		L(MM)	€		
AU4/66	NEW BLANC MAT	ALUMINIUM	CADRE DE MONTAGE EN SAILLIE POUR DALLES 600X600MM		600	65,00		
AU4/66/LINK	NEW BLANC MAT	ALUMINIUM	MODULE DE LIAISON 600MM POUR CADRE DE MONTAGE EN SAILLIE		600	45,00		
AZ7	NEW BLANC MAT	INOX	KIT DE SUSPENSION L:1000MM			30,00		
LEDEP10			KIT ECLAIRAGE DE SECOURS		199		221,00	





SOLIS IP65

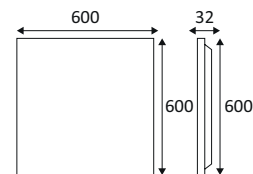

- Dalle LED 600x600mm.
- Diffuseur en polypropylène.
- Peut être recouvert par un isolant, à l'exception du convertisseur.
- Convertisseur non dimmable déporté fourni.
- Kit de montage en saillie ou kit de suspension à commander séparément.
- Kit d'éclairage de secours en option.

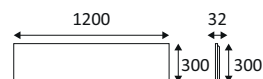
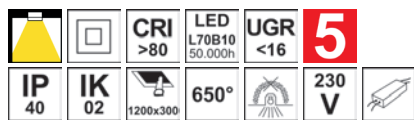

SOLIS IP65	COULEUR	MATIÈRE	P	T°	L(MM)	LED LUMEN	SYSTEM LUMEN	α	€
SOLIP66N4K	BLANC	ALUMINIUM	40W	4000K	600	5400Lm	4500Lm	110°	124,00
ACCESSOIRES	COULEUR	MATIÈRE	DESCRIPTION			L(MM)	€		
AU4/66	NEW BLANC MAT	ALUMINIUM	CADRE DE MONTAGE EN SAILLIE POUR DALLES 600X600MM			600	65,00		
AU4/66/LINK	NEW BLANC MAT	ALUMINIUM	MODULE DE LIAISON 600MM POUR CADRE DE MONTAGE EN SAILLIE			600	45,00		
AZ7	NEW BLANC MAT	INOX	KIT DE SUSPENSION L:1000MM				30,00		
LEDEP10			KIT ECLAIRAGE DE SECOURS			199		221,00	

SOLIS 2



- Dalle LED 1200x300mm.
- Diffuseur PS à structure prismatique.
- Connecteur rapide et filin de sécurité (1m) inclus.
- Peut être recouvert par un isolant, à l'exception du convertisseur.
- Convertisseur non dimmable déporté fourni.
- Convertisseur dimmable DALI, Push-Dim et 0-10V en option.
- Kit de montage en saillie ou kit de suspension à commander séparément.
- Kit d'éclairage de secours en option.



SOLIS 2	COULEUR	MATIÈRE	P	T°	L(MM)	LED LUMEN	SYSTEM LUMEN	α	€
P2B16S30WA	BLANC	ALUMINIUM	30W	4000K	1200	4125Lm	3450Lm	90°	72,00
ACCESSOIRES	COULEUR	MATIÈRE	DESCRIPTION			L(MM)	€		
AU4/312	NEW BLANC MAT	ALUMINIUM	CADRE DE MONTAGE EN SAILLIE POUR DALLES 1200X300MM			1200	80,00		
AU4/312/LINK	NEW BLANC MAT	ALUMINIUM	MODULE DE LIAISON 300MM POUR CADRE DE MONTAGE EN SAILLIE			300	38,00		
AZ7	NEW BLANC MAT	INOX	KIT DE SUSPENSION L:1000MM				30,00		
LEDEP10			KIT ECLAIRAGE DE SECOURS			199		221,00	
CONVERTISSEURS ET SOURCES				WATT MAX	€				
PS6501100MA	DRIVER 40W 650-1100MA CC DALI PUSH-DIM 0-10V			40W	60,00				



SOLIS 3

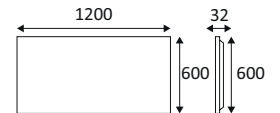
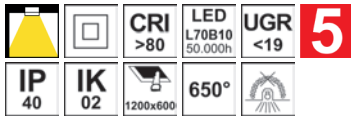

- Dalle LED 1200x600mm.
- Diffuseur PS à structure prismatique.
- Connecteur rapide et filin de sécurité (1m) inclus.
- Peut être recouvert par un isolant, à l'exception du convertisseur.
- Convertisseur non dimmable déporté fourni ou convertisseur à commander séparément.
- Convertisseur dimmable DALI / Push-Dim en option.
- Kit de montage en saillie à commander séparément.
- Kit d'éclairage de secours en option.

SOLIS 3	COULEUR	MATIÈRE	P	T°	L(MM)	LED LUMEN	SYSTEM LUMEN	α	€
CONVERTISSEUR EXCLU									
P2C19X60WA	BLANC	ALUMINIUM	60W	4000K	1200	8250Lm	6600Lm	90°	110,00
CONVERTISSEUR INCLUS									
P2C19S60WA	BLANC	ALUMINIUM	60W	4000K	1200	8250Lm	6600Lm	90°	137,00
ACCESSOIRES	COULEUR	MATIÈRE	DESCRIPTION			L(MM)			€
P2SMC	BLANC	ALUMINIUM	KIT DE MONTAGE EN SAILLIE			1200			73,00
LEDEP10			KIT ECLAIRAGE DE SECOURS			199			221,00
CONVERTISSEURS ET SOURCES				WATT MAX	€				
TR28000677	DRIVER 60W 900-1750MA CC DALI PUSH-DIM				60W	77,00			

DOMINO



- Dalle LED 600x600mm.
- Lentilles en polycarbonate.
- Connecteur rapide et filin de sécurité inclus.
- Peut être recouvert par un isolant, à l'exception du convertisseur.
- Convertisseur dimmable DALI, Push-Dim et 0-10V à commander séparément.
- Kit de montage en saillie ou kit de suspension à commander séparément.
- Kit d'éclairage de secours en option.

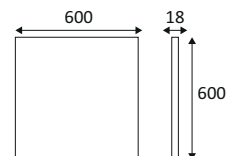

DOMINO	COULEUR	MATIÈRE	P	T°	L(MM)	SYSTEM LUMEN	α	€
DMB66X4K	NOIR	ACIER	27W	4000K	600	4350Lm	75°	130,00
DMW66X4K	BLANC	ACIER	27W	4000K	600	4350Lm	75°	130,00

ACCESSOIRES	COULEUR	MATIÈRE	DESCRIPTION	L(MM)	€
AU4/66	NEW BLANC MAT	ALUMINIUM	CADRE DE MONTAGE EN SAILLIE POUR DALLES 600X600MM	600	65,00
AU4/66/LINK	NEW BLANC MAT	ALUMINIUM	MODULE DE LIAISON 600MM POUR CADRE DE MONTAGE EN SAILLIE	600	45,00
AZ7	NEW BLANC MAT	INOX	KIT DE SUSPENSION L:1000MM		30,00
LEDEP10			KIT ECLAIRAGE DE SECOURS	199	221,00

CONVERTISSEURS ET SOURCES	WATT MAX	€
PS6501100MA DRIVER 40W 650-1100MA CC DALI PUSH-DIM 0-10V	40W	60,00



NOIR

BLANC



- Dalle LED pour faux-plafond modulaire.
- Excellent confort visuel grâce à un UGR inférieur à 16. Convient à l'éclairage de bureaux et salles de classe.
- Choix du mode de variation : convertisseur DALI, Push-dim et 0-10V à commander séparément.
- Rendement élevé (efficacité lumineuse supérieure à 160lm/W).
- Installation rapide et sûre grâce aux connecteur rapide et filin de sécurité inclus.
- Très bonne résistance aux chocs (IK08).
- Garantie de 5 ans.
- Kit d'éclairage de secours disponible en option.



DOMINO CSP

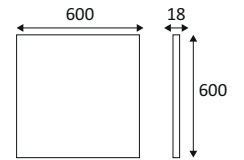
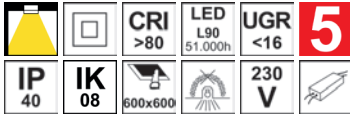

- Dalle LED 600x600mm.
- Lentilles en polycarbonate.
- Connecteur rapide et filin de sécurité inclus.
- Peut être recouvert par un isolant, à l'exception du convertisseur.
- Convertisseur non dimmable déporté fourni.
- Multi-puissance : 22, 24, 25 ou 27W au choix via un interrupteur sur le convertisseur.
- Kit de montage en saillie ou kit de suspension à commander séparément.
- Kit d'éclairage de secours en option.

DOMINO CSP	COULEUR	MATIÈRE	LED	T°	L(MM)	SYSTEM LUMEN	α	€
DMB66N4K	■ NOIR	ACIER	22W 24W 25W 27W	4000K	600	3550 Lm 3850 Lm 4100 Lm 4350 Lm	75°	139,00
DMW66N4K	■ BLANC	ACIER	22W 24W 25W 27W	4000K	600	3550 Lm 3850 Lm 4100 Lm 4350 Lm	75°	139,00
ACCESSOIRES	COULEUR	MATIÈRE	DESCRIPTION		L(MM)	€		
AU4/66	NEW BLANC MAT	ALUMINIUM	CADRE DE MONTAGE EN SAILLIE POUR DALLES 600X600MM		600	65,00		
AU4/66/LINK	NEW BLANC MAT	ALUMINIUM	MODULE DE LIAISON 600MM POUR CADRE DE MONTAGE EN SAILLIE		600	45,00		
AZ7	NEW BLANC MAT	INOX	KIT DE SUSPENSION L:1000MM			30,00		
LEDEP10			KIT ECLAIRAGE DE SECOURS		199		221,00	



NOIR

BLANC

INDIGO

LIGHTING



ENCASTRÉS MURAUX



KO 703R

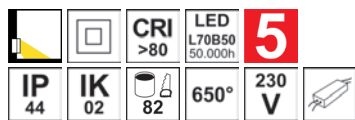

- Encastré mural décoratif rond pour l'éclairage de circulations.
- Verre de protection.
- Boîtier d'encastrement inclus.
- Convertisseur non dimmable intégré dans l'appareil.

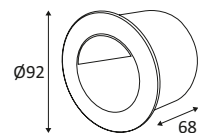
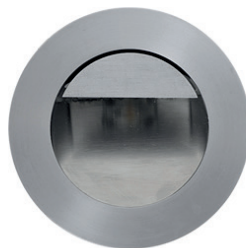

KO 703R	COULEUR	MATIÈRE	P	T°	LED LUMEN	SYSTEM LUMEN	€
KO703R	ALUMINIUM	ALUMINIUM	1W	3000K	120Lm	55Lm	86,00

KO 703S



- Encastré mural décoratif carré pour l'éclairage de circulations.
- Verre de protection.
- Boîtier d'encastrement inclus.
- Convertisseur non dimmable intégré dans l'appareil.

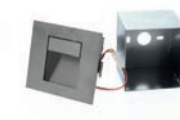
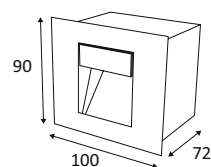
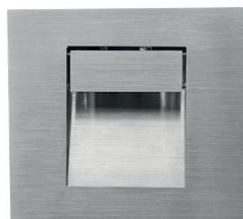

KO 703S	COULEUR	MATIÈRE	P	T°	L(MM)	LED LUMEN	SYSTEM LUMEN	€
KO703S	ACIER INOXYDABLE	INOX 304	1W	3000K	100	120Lm	55Lm	90,00

KO 703S

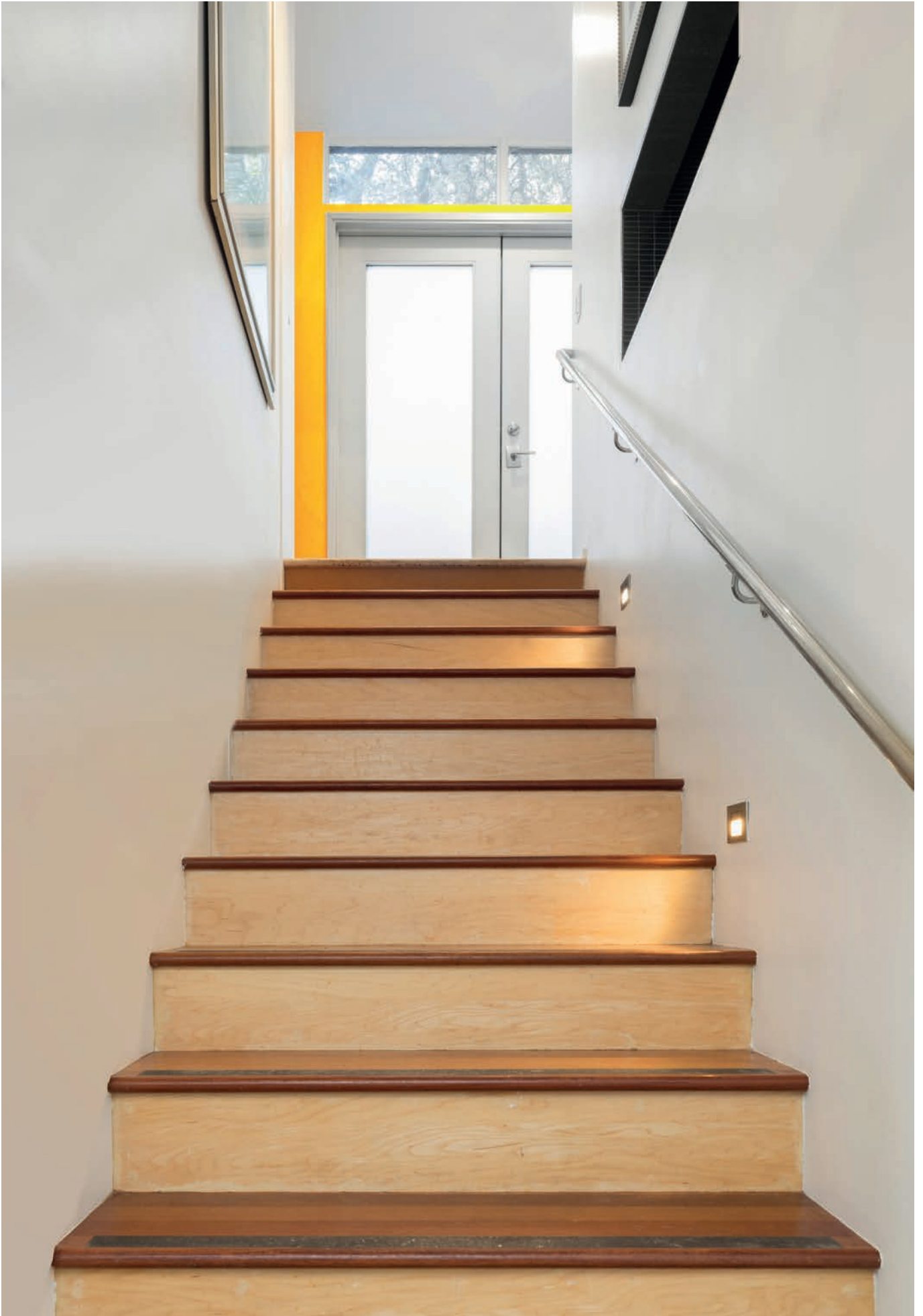

EVA 65R

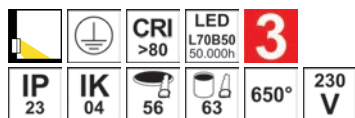

- Encastré mural décoratif rond pour l'éclairage de circulations.
- Fixation par lamelles.
- Boîtier d'encastrement inclus.
- Ne nécessite pas de convertisseur.
- Non dimmable.

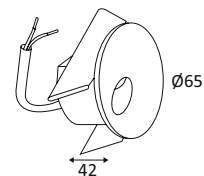

EVA 65R	COULEUR	MATIÈRE	P	T°	LED LUMEN	SYSTEM LUMEN	€
DW110R31	BLANC	ALUMINIUM	4W	3000K	420Lm	180Lm	100,00

EVA 65S

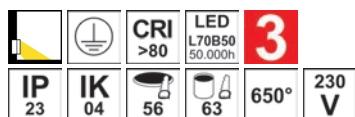

- Encastré mural décoratif carré pour l'éclairage de circulations.
- Fixation par lamelles.
- Boîtier d'encastrement inclus.
- Ne nécessite pas de convertisseur.
- Non dimmable.

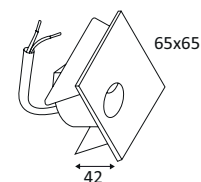
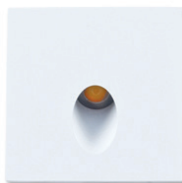

EVA 65S	COULEUR	MATIÈRE	P	T°	L(MM)	LED LUMEN	SYSTEM LUMEN	€
DW110S31	BLANC	ALUMINIUM	4W	3000K	65	420Lm	205Lm	100,00

EVA 65R



LIKA

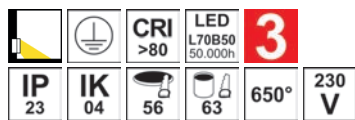

- Encastré mural décoratif carré pour l'éclairage de circulations.
- Fixation par lamelles.
- Boîtier d'encastrement inclus.
- Ne nécessite pas de convertisseur.
- Non dimmable.

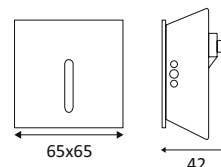

LIKA	COULEUR	MATIÈRE	P	T°	L(MM)	LED LUMEN	SYSTEM LUMEN	€
WA173WW05	■ NOIR MAT	ALUMINIUM	4W	3000K	65	420Lm	80Lm	100,00
WA173WW30	■ BLANC MAT	ALUMINIUM	4W	3000K	65	420Lm	80Lm	100,00



NOIR MAT

BLANC MAT





MAKA

		CRI >80	LED L70B50 50.000h	3
IP 23	IK 04			650°
		56	63	230 V

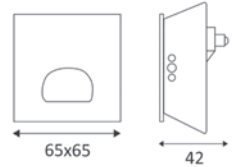

- Encastré mural décoratif carré pour l'éclairage de circulations.
- Fixation par lamelles.
- Boîtier d'encastrement inclus.
- Ne nécessite pas de convertisseur.
- Non dimmable.

MAKA	COULEUR	MATIÈRE	P	T°	L(MM)	LED LUMEN	SYSTEM LUMEN	€
WA174WW05	■ NOIR MAT	ALUMINIUM	4W	3000K	65	420Lm	210Lm	100,00
WA174WW30	■ BLANC MAT	ALUMINIUM	4W	3000K	65	420Lm	210Lm	100,00



NOIR MAT



BLANC MAT

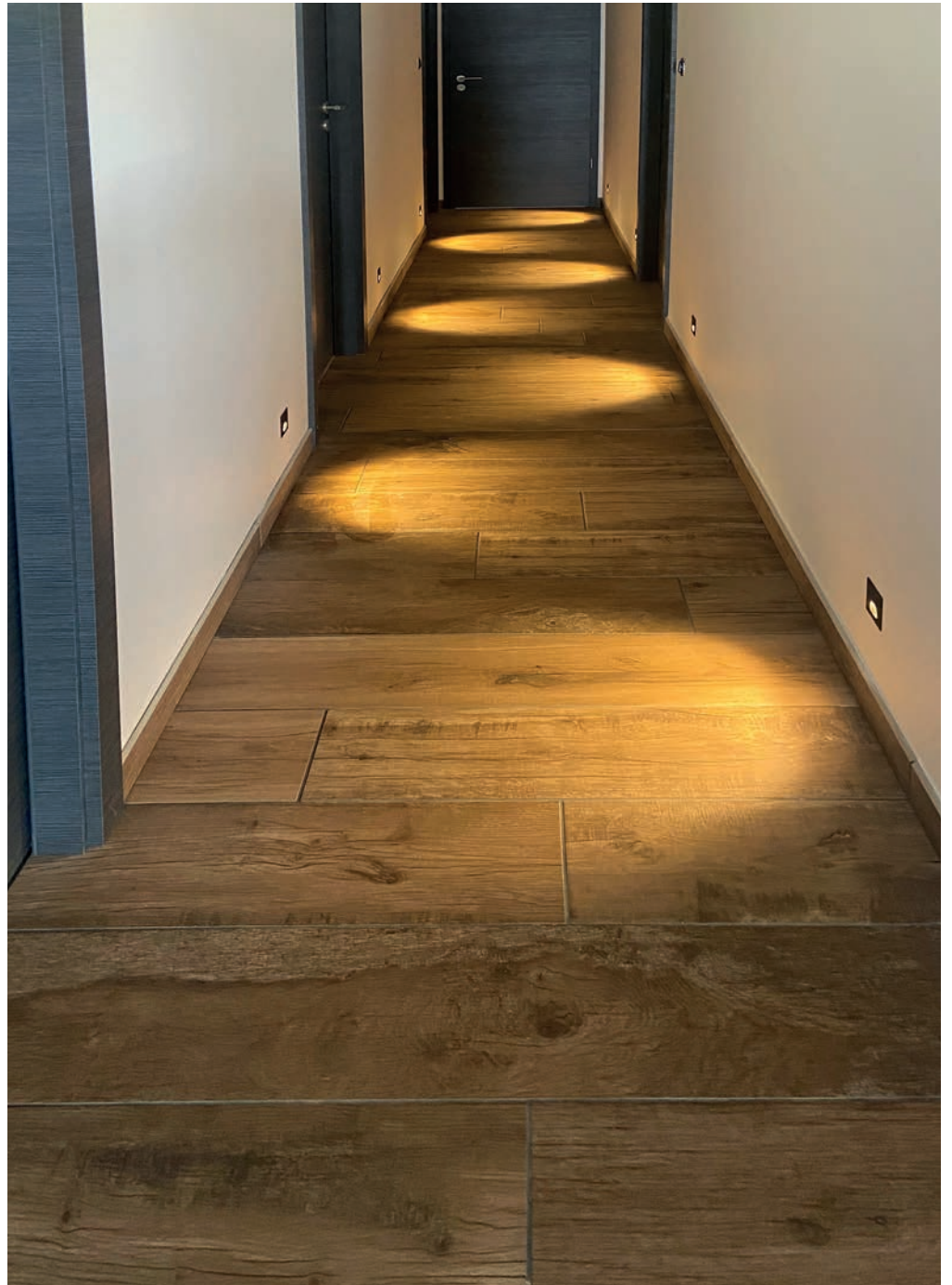

STEPBEAM

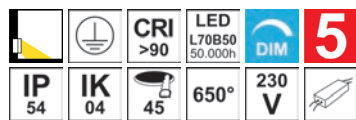

- Encastré mural décoratif pour l'éclairage de circulations.
- Face magnétique ronde ou carrée à commander séparément.
- Fixation par lamelles.
- Convertisseur dimmable déporté fourni.
- Compatible avec variateur début et fin de phase.

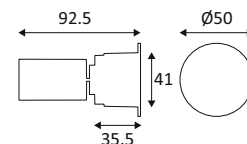

STEPBEAM		MATIÈRE	P	T°	LED LUMEN		€
STEPBEAM30	NEW	ALUMINIUM	2,7W	3000K	255Lm		63,00
ACCESSOIRES		COULEUR	DESCRIPTION		SYSTEM LUMEN	α	€
FACES CARRÉES - DIFFUSION CIRCULAIRE							
SBEZCIRCLEB	NEW	NOIR	FACE CARRÉE DIFFUSION CIRCULAIRE	65Lm		45°	6,00
SBEZCIRCLES	NEW	CHROME SATINÉ	FACE CARRÉE DIFFUSION CIRCULAIRE	65Lm		45°	8,00
SBEZCIRCLEW	NEW	BLANC	FACE CARRÉE DIFFUSION CIRCULAIRE	65Lm		45°	6,00
FACES CARRÉES - DIFFUSION DEMI-CIRCULAIRE							
SBEZHIRCLEB	NEW	NOIR	FACE CARRÉE DIFFUSION DEMI-CIRCULAIRE	28Lm		45°	6,00
SBEZHIRCLES	NEW	CHROME SATINÉ	FACE CARRÉE DIFFUSION DEMI-CIRCULAIRE	28Lm		45°	8,00
SBEZHIRCLEW	NEW	BLANC	FACE CARRÉE DIFFUSION DEMI-CIRCULAIRE	28Lm		45°	6,00
FACES CARRÉES - DIFFUSION LINÉAIRE							
SBEZSLOTB	NEW	NOIR	FACE CARRÉE DIFFUSION LINÉAIRE	28Lm		30°	6,00
SBEZSLOTW	NEW	BLANC	FACE CARRÉE DIFFUSION LINÉAIRE	28Lm		30°	6,00
SBEZSLOTWS	NEW	CHROME SATINÉ	FACE CARRÉE DIFFUSION LINÉAIRE	28Lm		30°	8,00
FACES RONDES - DIFFUSION CIRCULAIRE							
RBEZCIRCLEB	NEW	NOIR	FACE RONDE DIFFUSION CIRCULAIRE	65Lm		45°	6,00
RBEZCIRCLES	NEW	CHROME SATINÉ	FACE RONDE DIFFUSION CIRCULAIRE	65Lm		45°	8,00
RBEZCIRCLEW	NEW	BLANC	FACE RONDE DIFFUSION CIRCULAIRE	65Lm		45°	6,00
FACES RONDES - DIFFUSION DEMI-CIRCULAIRE							
RBEZHIRCLEB	NEW	NOIR	FACE RONDE DIFFUSION DEMI-CIRCULAIRE	28Lm		45°	6,00
RBEZHIRCLES	NEW	CHROME SATINÉ	FACE RONDE DIFFUSION DEMI-CIRCULAIRE	28Lm		45°	8,00
RBEZHIRCLEW	NEW	BLANC	FACE RONDE DIFFUSION DEMI-CIRCULAIRE	28Lm		45°	6,00
FACES RONDES - DIFFUSION LINÉAIRE							
RBEZSLOTB	NEW	NOIR	FACE RONDE DIFFUSION LINÉAIRE	28Lm		30°	6,00
RBEZSLOTW	NEW	BLANC	FACE RONDE DIFFUSION LINÉAIRE	28Lm		30°	6,00
RBEZSLOTWS	NEW	CHROME SATINÉ	FACE RONDE DIFFUSION LINÉAIRE	28Lm		30°	8,00

STEPBEAM



INDIGO

LIGHTING



APPLIQUES

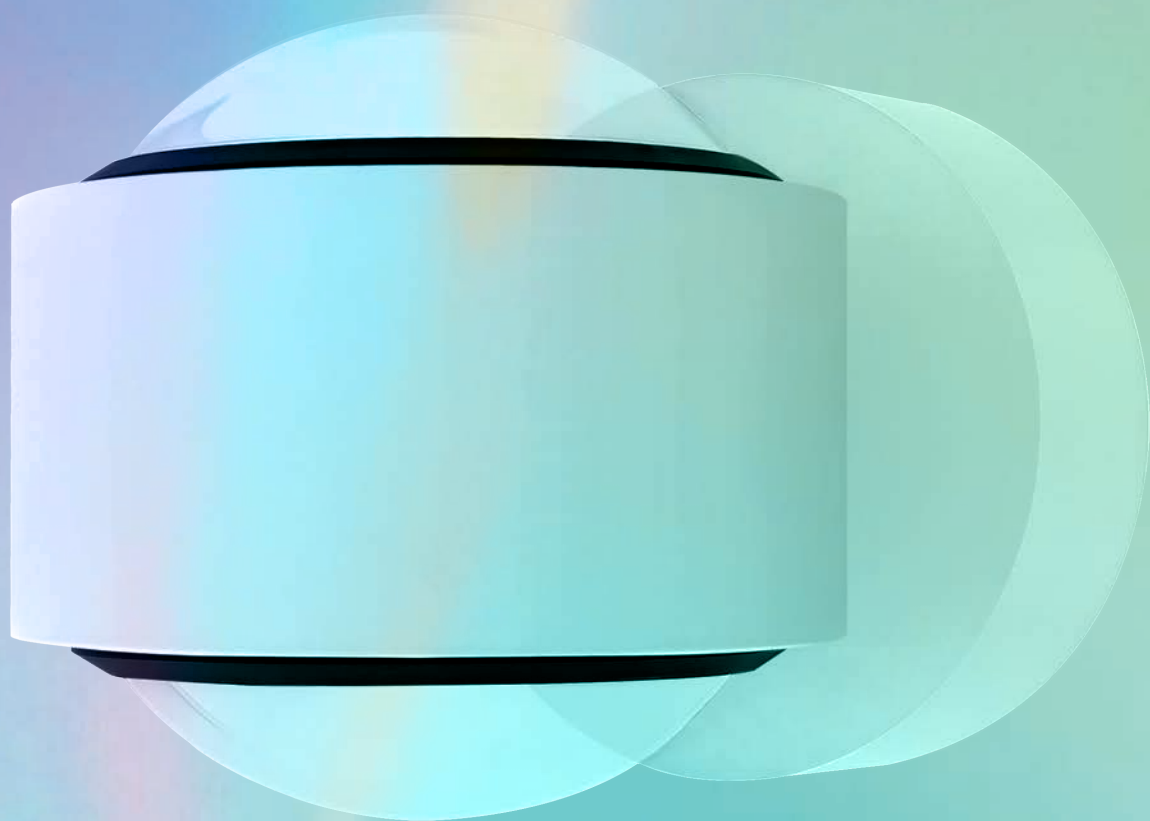

EVIA G9



- Applique murale décorative.
- Diffuseur en verre opalin.
- Lampe LED G9 8W 3000K incluse.

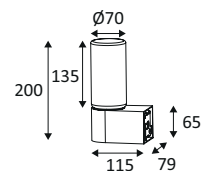

EVIA G9	COULEUR	MATIÈRE	SOQUET	WATT MAX	T°	LED LUMEN	SYSTEM LUMEN	€
WA25404	BLANC	ACIER	G9	8W	3000K	900Lm	570Lm	130,00
WA25403	CHROME	ACIER	G9	8W	3000K	900Lm	570Lm	129,00
WA25445	NICKEL MAT	ACIER	G9	8W	3000K	900Lm	570Lm	141,00
WA25461	LAITON BROSSÉ	INOX	G9	8W	3000K	900Lm	570Lm	168,00



BLANC



CHROME



NICKEL MAT



LAITON BROSSÉ

VITEL GX53



- Applique murale ou plafonnier décoratif.
- Diffuseur en verre pyramidal clair.
- Lampe LED GX53 9W 3000K incluse.

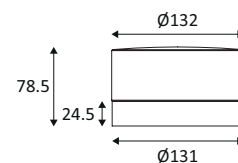

VITEL GX53	COULEUR	MATIÈRE	SOQUET	WATT MAX	T°	LED LUMEN	SYSTEM LUMEN	€
WA25330	BLANC MAT	POLYCARBONATE	GX53	9W	3000K	800Lm	525Lm	151,00
WA25303	CHROME	POLYCARBONATE	GX53	9W	3000K	800Lm	525Lm	153,00
WA25345	NICKEL MAT	POLYCARBONATE	GX53	9W	3000K	800Lm	525Lm	156,00
WA25361	LAITON BROSSÉ	POLYCARBONATE	GX53	9W	3000K	800Lm	525Lm	163,00



BLANC MAT



CHROME



NICKEL MAT



LAITON BROSSÉ



OKTO 2 GU10



- Applique murale décorative.
- Eclairage «up&down».

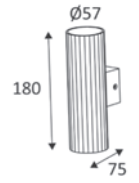

OKTO 2 GU10	COULEUR	MATIÈRE	SOQUET	LAMPE	WATT MAX	€
WA23405	■ NOIR MAT	ALUMINIUM	GU10	PAR16 LED	2x10W	52,00
WA23408	■ NOIR MAT - CHAMPAGNE	ALUMINIUM	GU10	PAR16 LED	2x10W	54,00
WA23406	■ NOIR MAT - OR ROSE	ALUMINIUM	GU10	PAR16 LED	2x10W	54,00
WA23483	■ NOIR MAT - ROSE	ALUMINIUM	GU10	PAR16 LED	2x10W	54,00
WA23430	■ BLANC MAT	ALUMINIUM	GU10	PAR16 LED	2x10W	52,00

DANS LA MÊME GAMME



NOIR MAT



NOIR MAT - CHAMPAGNE



NOIR MAT - OR ROSE



NOIR MAT - ROSE



BLANC MAT



OKTO GU10 PAGE 182



OKTO 1 C GU10 PAGE 184



OKTO RX GU10 PAGE 87



OKTO C GU10 PAGE 183



OKTO P GU10 PAGE 218



SNOOP GU10



- Applique murale décorative pour éclairage intérieur et extérieur.
- Cache de finition magnétique adaptable en hauteur afin de modifier la luminosité.
- Avec entrée et sortie de câble.

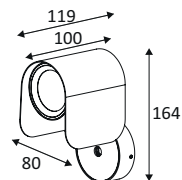

SNOOP GU10	COULEUR	MATIÈRE	SOQUET	LAMPE	WATT MAX	€
WA26105	■ NOIR MAT	ALUMINIUM	GU10	PAR16 LED	10W	80,00
WA26135	▨ NOIR MAT - BLANC MAT	ALUMINIUM	GU10	PAR16 LED	10W	80,00
WA26108	▨ NOIR MAT - CHAMPAGNE	ALUMINIUM	GU10	PAR16 LED	10W	95,00
WA26183	▨ NOIR MAT - ROSE	ALUMINIUM	GU10	PAR16 LED	10W	95,00



NOIR MAT



NOIR MAT - BLANC MAT



NOIR MAT - CHAMPAGNE



NOIR MAT - ROSE

SNOOP

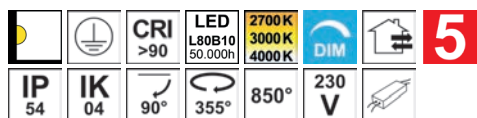

- Applique murale décorative pour éclairage intérieur et extérieur.
- Cache de finition magnétique adaptable en hauteur afin de modifier la luminosité.
- 2700K, 3000K ou 4000K au choix via un interrupteur à l'arrière du luminaire.
- Avec entrée et sortie de câble.
- Convertisseur dimmable intégré dans l'appareil.
- Compatible avec variateur fin de phase.

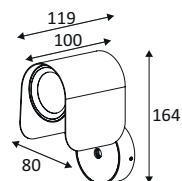

SNOOP	COULEUR	MATIÈRE	P	T°	LED LUMEN	SYSTEM LUMEN	α	€
WA26205	■ NOIR MAT	ALUMINIUM	10W	2700K 3000K 4000K	1050Lm (4000K)	865Lm (4000K)	38°	130,00
WA26235	▨ NOIR MAT - BLANC MAT	ALUMINIUM	10W	2700K 3000K 4000K	1050Lm (4000K)	865Lm (4000K)	38°	130,00
WA26208	▨ NOIR MAT - CHAMPAGNE	ALUMINIUM	10W	2700K 3000K 4000K	1050Lm (4000K)	865Lm (4000K)	38°	150,00
WA26283	▨ NOIR MAT - ROSE	ALUMINIUM	10W	2700K 3000K 4000K	1050Lm (4000K)	865Lm (4000K)	38°	150,00



NOIR MAT



NOIR MAT - BLANC MAT



NOIR MAT - CHAMPAGNE



NOIR MAT - ROSE

SNOOP



RETI W

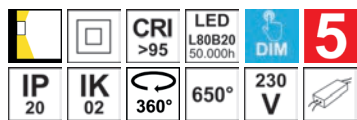

- Applique murale décorative.
- Eclairage «up&down».
- Faisceaux lumineux précisément dessinés grâce à des lentilles en verre de haute qualité.
- Avec 2 interrupteurs variateurs, sources réglables individuellement.
- Convertisseur dimmable intégré dans l'appareil.

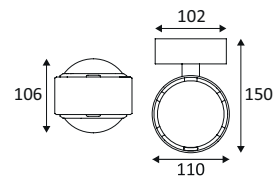
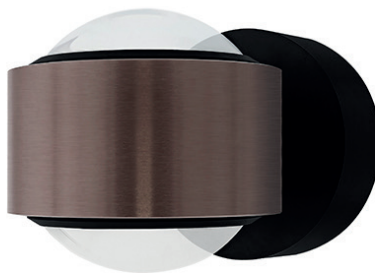

RETI W	COULEUR	MATIÈRE	P	T°	L(MM)	LED LUMEN	SYSTEM LUMEN	α	€
WA264WW05	NEW NOIR MAT	ALUMINIUM	18W	3000K	150	800Lm	1450Lm	80°	444,00
WA264WW31	NEW NOIR MAT - BRONZE SATINÉ	ALUMINIUM	18W	3000K	150	800Lm	1450Lm	80°	444,00
WA264WW30	NEW BLANC MAT	ALUMINIUM	18W	3000K	150	800Lm	1450Lm	80°	444,00



NOIR MAT

NOIR MAT - BRONZE SATINÉ

BLANC MAT

DANS LA MÊME GAMME



RETI 2 RX PAGE 94



RETI 1 RX PAGE 94



RETI P PAGE 222

RETI W

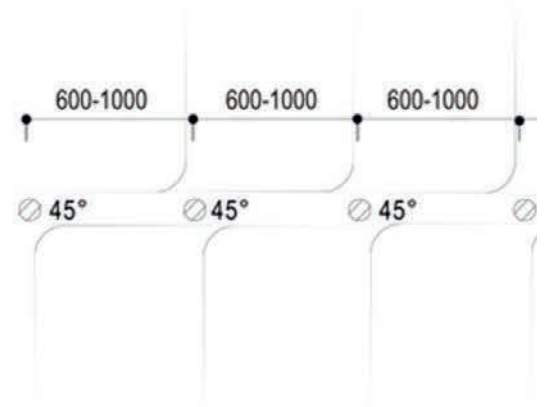
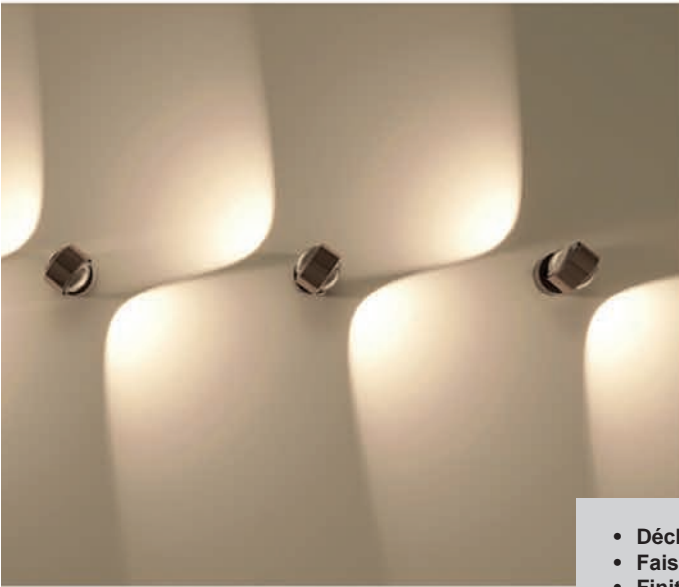

- Déclinable en applique, suspension ou semi-encasté.
- Faisceau lumineux précisément dessiné donnant un effet graphique.
- Finition de qualité supérieure.

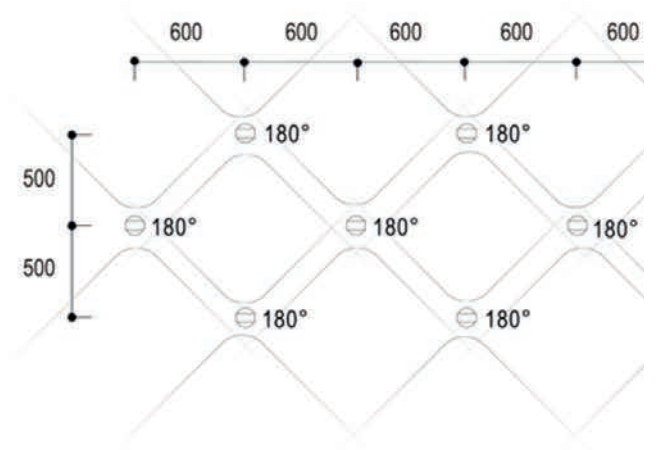
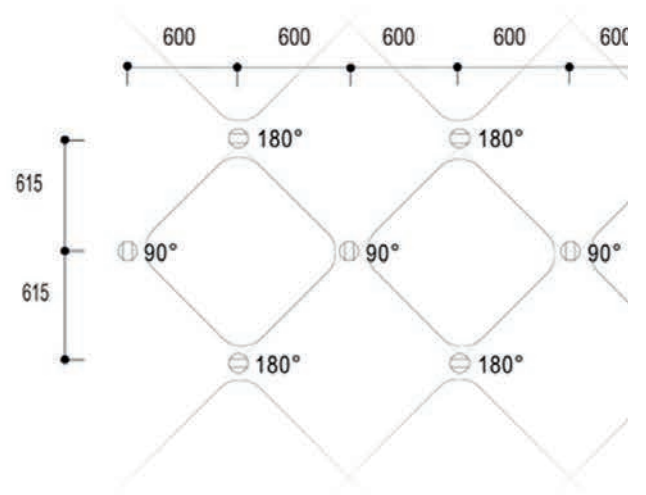

AUREA 1 W

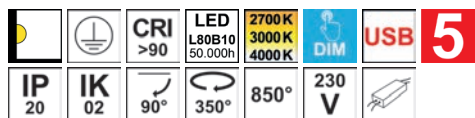

- Applique murale décorative.
- Base apparente avec interrupteur variateur et prise USB (5VDC, 2,4A).
- 2700K, 3000K ou 4000K au choix via un interrupteur à l'arrière du luminaire.
- Convertisseur dimmable intégré dans l'appareil.

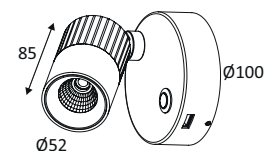

AUREA 1 W	COULEUR	MATIÈRE	P	T°	LED LUMEN	SYSTEM LUMEN	α	€
WA25805	■ NOIR MAT	ALUMINIUM	7W	2700K 3000K 4000K	625Lm (4000K)	500Lm (4000K)	38°	117,00
WA25808	■ NOIR MAT - CHAMPAGNE	ALUMINIUM	7W	2700K 3000K 4000K	625Lm (4000K)	500Lm (4000K)	38°	131,00
WA25883	■ NOIR MAT - ROSE	ALUMINIUM	7W	2700K 3000K 4000K	625Lm (4000K)	500Lm (4000K)	38°	131,00
WA25830	■ BLANC MAT	ALUMINIUM	7W	2700K 3000K 4000K	625Lm (4000K)	500Lm (4000K)	38°	117,00
WA25849	■ BLANC MAT - CHAMPAGNE	ALUMINIUM	7W	2700K 3000K 4000K	625Lm (4000K)	500Lm (4000K)	38°	131,00
WA25882	■ BLANC MAT - ROSE	ALUMINIUM	7W	2700K 3000K 4000K	625Lm (4000K)	500Lm (4000K)	38°	131,00

DANS LA MÊME GAMME



NOIR MAT



NOIR MAT - CHAMPAGNE



NOIR MAT - ROSE



BLANC MAT



BLANC MAT - CHAMPAGNE



BLANC MAT - ROSE



AUREA P PAGE 219



AUREA 2 C PAGE 196



AUREA 1 C PAGE 195

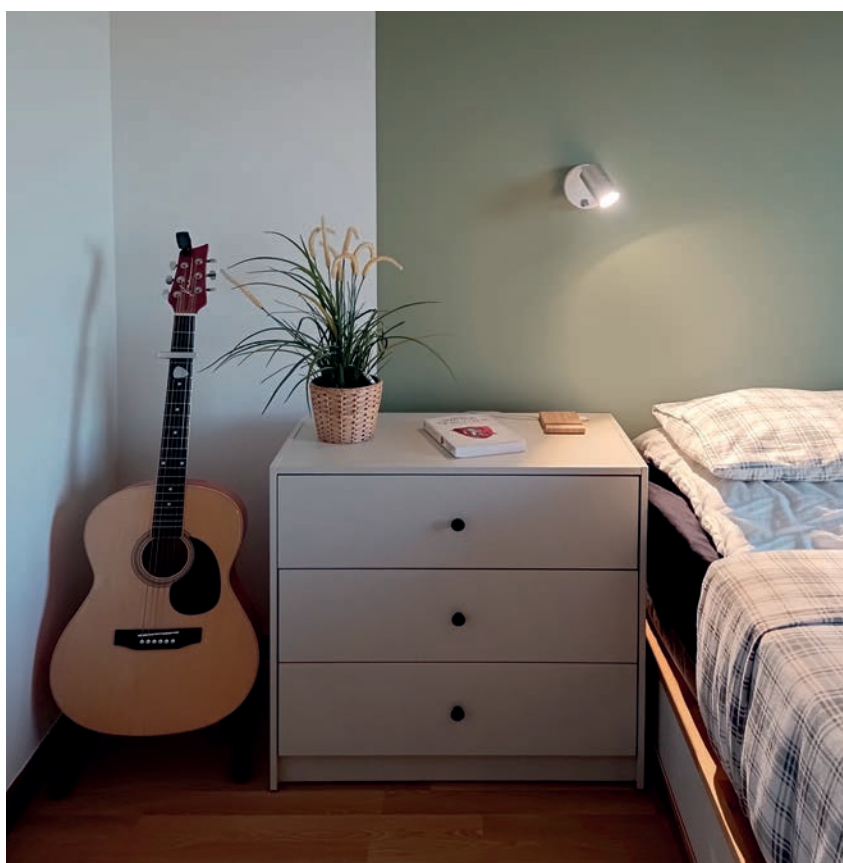



AUREA 2 W

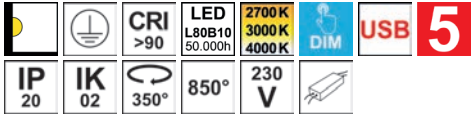

- Applique murale décorative.
- Base apparente avec interrupteur variateur et prise USB (5VDC, 2,4A).
- Longueur du flexible 250mm.
- 2700K, 3000K ou 4000K au choix via un interrupteur à l'arrière du luminaire.
- Convertisseur dimmable intégré dans l'appareil.



AUREA 2 W	COULEUR	MATIÈRE	P	T°	L(MM)	LED LUMEN	SYSTEM LUMEN	α	€
WA25905	■ NOIR MAT	ALUMINIUM	7W	2700K 3000K 4000K	85	625Lm (4000K)	500Lm (4000K)	38°	119,00
WA25908	▣ NOIR MAT - CHAMPAGNE	ALUMINIUM	7W	2700K 3000K 4000K	85	625Lm (4000K)	500Lm (4000K)	38°	131,00
WA25983	▣ NOIR MAT - ROSE	ALUMINIUM	7W	2700K 3000K 4000K	85	625Lm (4000K)	500Lm (4000K)	38°	131,00
WA25930	■ BLANC MAT	ALUMINIUM	7W	2700K 3000K 4000K	85	625Lm (4000K)	500Lm (4000K)	38°	119,00
WA25949	▣ BLANC MAT - CHAMPAGNE	ALUMINIUM	7W	2700K 3000K 4000K	85	625Lm (4000K)	500Lm (4000K)	38°	131,00
WA25982	▣ BLANC MAT - ROSE	ALUMINIUM	7W	2700K 3000K 4000K	85	625Lm (4000K)	500Lm (4000K)	38°	131,00

DANS LA MÊME GAMME



NOIR MAT

NOIR MAT -
CHAMPAGNE

NOIR MAT - ROSE



BLANC MAT

BLANC MAT -
CHAMPAGNE

BLANC MAT - ROSE



AUREA P PAGE 219



AUREA 2 C PAGE 196



AUREA 1 C PAGE 195

AUREA 3 W

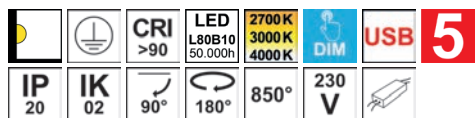

- Applique murale décorative.
- Base apparente avec interrupteur variateur et prise USB (5VDC, 2,4A).
- 2700K, 3000K ou 4000K au choix via un interrupteur à l'arrière du luminaire.
- Convertisseur dimmable intégré dans l'appareil.

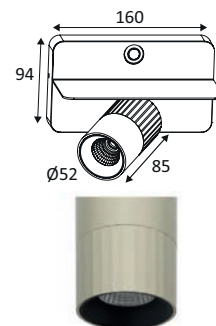

AUREA 3 W	COULEUR	MATIÈRE	P	T°	L(MM)	LED LUMEN	SYSTEM LUMEN	α	€
WA26005	■ NOIR MAT	ALUMINIUM	7W	2700K 3000K 4000K	160	625Lm (4000K)	500Lm (4000K)	38°	135,00
WA26008	■ NOIR MAT - CHAMPAGNE	ALUMINIUM	7W	2700K 3000K 4000K	160	625Lm (4000K)	500Lm (4000K)	38°	154,00
WA26083	■ NOIR MAT - ROSE	ALUMINIUM	7W	2700K 3000K 4000K	160	625Lm (4000K)	500Lm (4000K)	38°	154,00
WA26030	■ BLANC MAT	ALUMINIUM	7W	2700K 3000K 4000K	160	625Lm (4000K)	500Lm (4000K)	38°	135,00
WA26049	■ BLANC MAT - CHAMPAGNE	ALUMINIUM	7W	2700K 3000K 4000K	160	625Lm (4000K)	500Lm (4000K)	38°	154,00
WA26082	■ BLANC MAT - ROSE	ALUMINIUM	7W	2700K 3000K 4000K	160	625Lm (4000K)	500Lm (4000K)	38°	154,00

DANS LA MÊME GAMME





AUREA 4 W

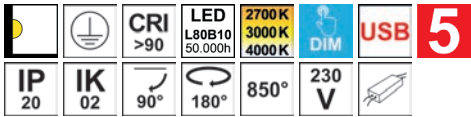

- Applique murale décorative.
- Base apparente avec interrupteur variateur, prise USB (5VDC, 2,4A) et chargeur sans-fil (pour smartphones compatibles).
- La charge par induction nécessite que le smartphone soit mis en contact direct avec la surface de recharge, sans protection ou coque.
- 2700K, 3000K ou 4000K au choix via un interrupteur à l'arrière du luminaire.
- Convertisseur dimmable intégré dans l'appareil.



AUREA 4 W	COULEUR	MATIÈRE	P	T°	L(MM)	LED LUMEN	SYSTEM LUMEN	α	€
WA26305	■ NOIR MAT	ALUMINIUM	7W	2700K 3000K 4000K	160	625Lm (4000K)	500Lm (4000K)	38°	138,00
WA26308	▣ NOIR MAT - CHAMPAGNE	ALUMINIUM	7W	2700K 3000K 4000K	160	625Lm (4000K)	500Lm (4000K)	38°	152,00
WA26383	▣ NOIR MAT - ROSE	ALUMINIUM	7W	2700K 3000K 4000K	160	625Lm (4000K)	500Lm (4000K)	38°	152,00
WA26330	■ BLANC MAT	ALUMINIUM	7W	2700K 3000K 4000K	160	625Lm (4000K)	500Lm (4000K)	38°	138,00
WA26349	▣ BLANC MAT - CHAMPAGNE	ALUMINIUM	7W	2700K 3000K 4000K	160	625Lm (4000K)	500Lm (4000K)	38°	152,00
WA26382	▣ BLANC MAT - ROSE	ALUMINIUM	7W	2700K 3000K 4000K	160	625Lm (4000K)	500Lm (4000K)	38°	152,00

DANS LA MÊME GAMME



NOIR MAT



NOIR MAT - CHAMPAGNE



NOIR MAT - ROSE



BLANC MAT



BLANC MAT - CHAMPAGNE



BLANC MAT - ROSE



AUREA P PAGE 219



AUREA 2 C PAGE 196



AUREA 1 C PAGE 195



MILO 1

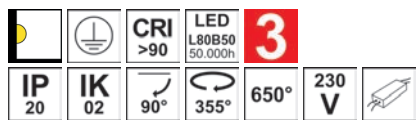

- Applique murale décorative.
- Base apparente avec interrupteur.
- Convertisseur non dimmable intégré dans l'appareil.

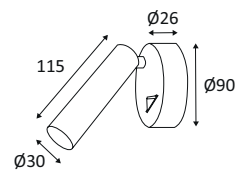

MILO 1	COULEUR	MATIÈRE	P	T°	L(MM)	LED LUMEN	SYSTEM LUMEN	α	€
WA11205	■ NOIR MAT	ALUMINIUM	5W	3000K	115	500Lm	405Lm	40°	152,00
WA11230	■ BLANC MAT	ALUMINIUM	5W	3000K	115	500Lm	450Lm	40°	152,00



NOIR MAT



BLANC MAT





MILO 2

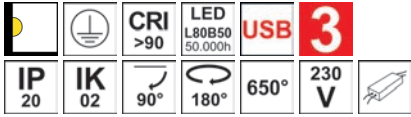

- Applique murale décorative.
- Base apparente avec interrupteur permettant trois niveaux d'éclairage (25%, 50% et 100%) et deux prises USB (5VDC, 2A).
- Convertisseur non dimmable intégré dans l'appareil.

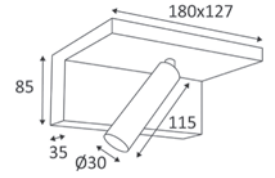

MILO 2	COULEUR	MATIÈRE	P	T°	L(MM)	LED LUMEN	SYSTEM LUMEN	α	€
WA165WW05	■ NOIR MAT	ALUMINIUM	5W	3000K	180	500Lm	405Lm	40°	205,00
WA165WW30	■ BLANC MAT	ALUMINIUM	5W	3000K	180	500Lm	450Lm	40°	205,00



NOIR MAT



BLANC MAT



MILO 3

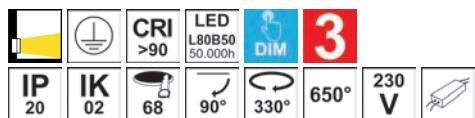

- Applique murale décorative.
- Base semi-encastree.
- Avec interrupteur variateur.
- Livree avec convertisseur dimmable.
- Montage dans un boitier d'encastrement standard (non fourni).

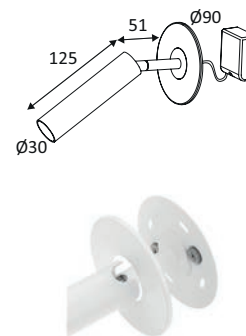

MILO 3	COULEUR	MATIÈRE	P	T°	L(MM)	LED LUMEN	SYSTEM LUMEN	α	€
WA215SW05	■ NOIR MAT	ALUMINIUM	5W	2700K	125	460Lm	395Lm	40°	127,00
WA215SW30	■ BLANC MAT	ALUMINIUM	5W	2700K	125	460Lm	395Lm	40°	127,00
WA215SW63	■ LAITON BROSSÉ	ALUMINIUM	5W	2700K	125	460Lm	395Lm	40°	133,00



NOIR MAT



BLANC MAT



LAITON BROSSÉ

MILO 4

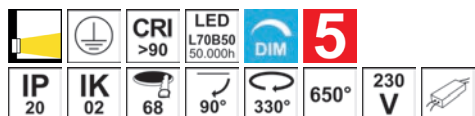

- Applique murale décorative.
- Base semi-encastree.
- Convertisseur dimmable deporté fourni.
- Compatible avec variateur debut et fin de phase.
- Montage dans un boitier d'encastrement standard (non fourni).

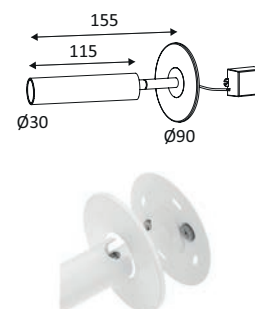

MILO 4	COULEUR	MATIÈRE	P	T°	L(MM)	LED LUMEN	SYSTEM LUMEN	α	€
WA235SW05	■ NOIR MAT	ALUMINIUM	5W	2700K	115	465Lm	445Lm	40°	135,00
WA235SW30	■ BLANC MAT	ALUMINIUM	5W	2700K	115	465Lm	445Lm	40°	135,00
WA235SW63	■ LAITON BROSSÉ	ALUMINIUM	5W	2700K	115	465Lm	445Lm	40°	149,00



NOIR MAT



BLANC MAT



LAITON BROSSÉ

MILO 4



KAVA

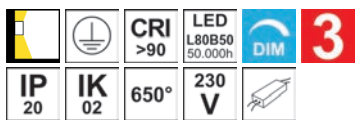

- Applique murale décorative.
- Eclairage «up&down».
- Convertisseur dimmable intégré dans l'appareil.

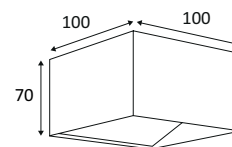
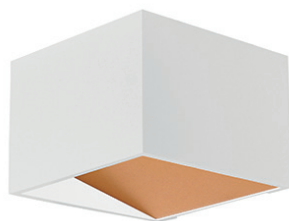

KAVA	COULEUR	MATIÈRE	P	T°	L(MM)	LED LUMEN	SYSTEM LUMEN	€
WA209WW18	NOIR MAT - DORÉ	ALUMINIUM	5W	3000K	100	500Lm	280Lm	160,00
KU147916	BLANC MAT	ALUMINIUM	5W	3000K	100	500Lm	485Lm	181,00
WA209WW80	BLANC MAT - DORÉ	ALUMINIUM	5W	3000K	100	500Lm	340Lm	160,00



NOIR MAT - DORÉ

BLANC MAT

BLANC MAT - DORÉ





FULLA

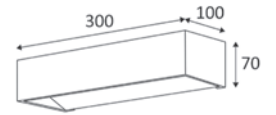
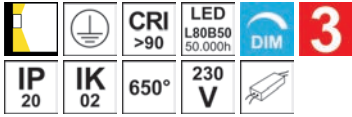

- Applique murale décorative.
- Eclairage «up&down».
- Convertisseur dimmable intégré dans l'appareil.
- Compatible avec variateur début et fin de phase.

FULLA	COULEUR	MATIÈRE	P	T°	L(MM)	LED LUMEN	SYSTEM LUMEN	€
WA169WW30	BLANC MAT	ALUMINIUM	15W	3000K	300	1900Lm	1430Lm	232,00



GLAM 265

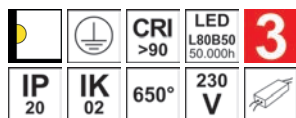

- Applique murale décorative.
- Convertisseur non dimmable intégré dans l'appareil.

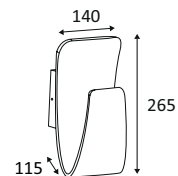

GLAM 265	COULEUR	MATIÈRE	P	T°	L(MM)	LED LUMEN	SYSTEM LUMEN	€
WA11018	NOIR MAT - DORÉ	ALUMINIUM	7,5W	3000K	265	900Lm	385Lm	216,00

GLAM 90



- Applique murale décorative.
- Eclairage «up&down».
- Convertisseur dimmable intégré dans l'appareil.
- Compatible avec variateur début et fin de phase.

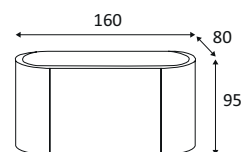

GLAM 90	COULEUR	MATIÈRE	P	T°	L(MM)	LED LUMEN	SYSTEM LUMEN	€
WA175WW18	NOIR MAT - DORÉ	ALUMINIUM	10W	3000K	160	1010Lm	450Lm	164,00
WA175WW17	NOIR MAT - ARGENT	ALUMINIUM	10W	3000K	160	1010Lm	680Lm	164,00



NOIR MAT - DORÉ NOIR MAT - ARGENT



GLAM 250

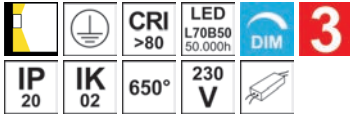

- Applique murale décorative.
- Eclairage «up&down».
- Convertisseur dimmable intégré dans l'appareil.
- Compatible avec variateur début et fin de phase.

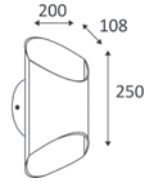

GLAM 250	COULEUR	MATIÈRE	P	T°	L(MM)	LED LUMEN	SYSTEM LUMEN	€
WA176WW18	NOIR MAT - DORÉ	ALUMINIUM	12W	3000K	250	1010Lm	360Lm	200,00
WA176WW17	NOIR MAT - ARGENT	ALUMINIUM	12W	3000K	250	1010Lm	520Lm	200,00

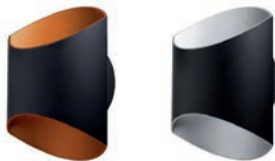

NOIR MAT - DORÉ NOIR MAT - ARGENT



BIXBY

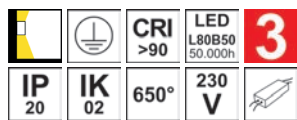

- Applique murale décorative.
- Eclairage «up&down».
- Convertisseur non dimmable intégré dans l'appareil.

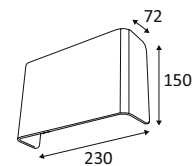

BIXBY	COULEUR	MATIÈRE	P	T°	L(MM)	LED LUMEN	SYSTEM LUMEN	€
WA12830	BLANC MAT	ALUMINIUM	12W	3000K	230	1250Lm	755Lm	205,00
WA12841	ALUMINIUM POLI	ALUMINIUM	12W	3000K	230	1250Lm	755Lm	205,00
WA12840	BOIS GRIS	BOIS	12W	3000K	230	1250Lm	755Lm	205,00
WA12842	BOIS CLAIR	BOIS	12W	3000K	230	1250Lm	755Lm	205,00

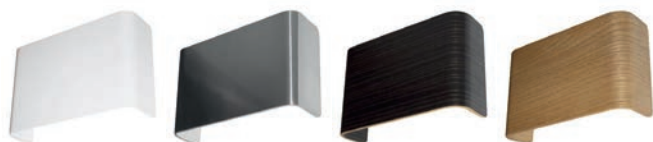

BLANC MAT

ALUMINIUM POLI

BOIS GRIS

BOIS CLAIR





ELLA

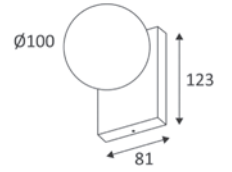
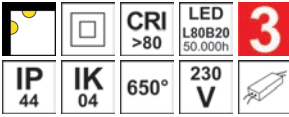

- Applique murale décorative.
- Diffuseur en verre opalin.
- Convertisseur non dimmable intégré dans l'appareil.

ELLA	COULEUR	MATIÈRE	P	T°	LED LUMEN	SYSTEM LUMEN	α	€
WA252WW05	■ NOIR MAT	ALUMINIUM	4W	3000K	375Lm	245Lm	180°	154,00
WA252WW30	■ BLANC MAT	ALUMINIUM	4W	3000K	375Lm	245Lm	180°	154,00
WA252WW10	■ CHAMPAGNE	ALUMINIUM	4W	3000K	375Lm	245Lm	180°	175,00



NOIR MAT



BLANC MAT



CHAMPAGNE

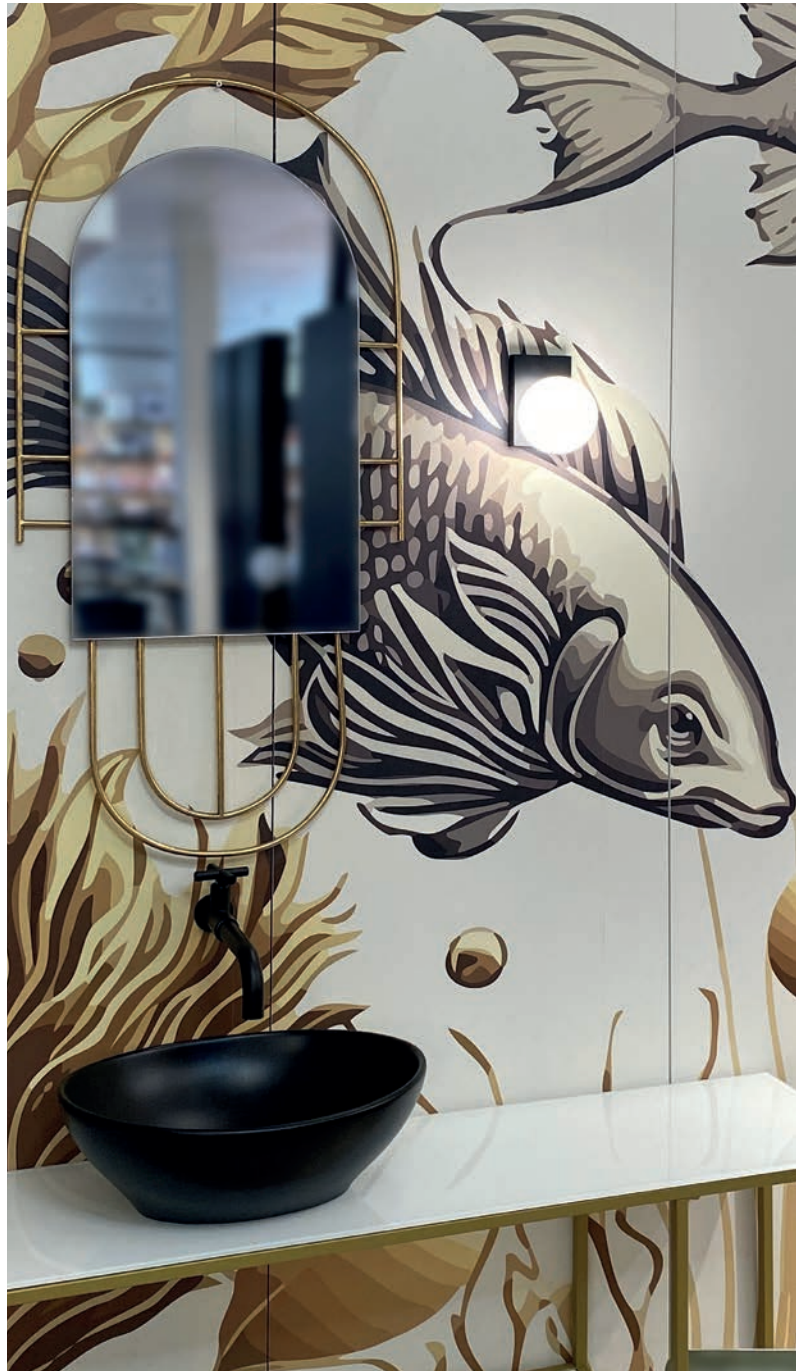

FOLD 1

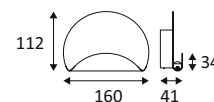

- Applique murale décorative.
- Eclairage indirect.
- Convertisseur non dimmable intégré dans l'appareil.

FOLD 1	COULEUR	MATIÈRE	P	T°	L(MM)	LED LUMEN	SYSTEM LUMEN	€
WA236WW30	BLANC MAT	ALUMINIUM	4W	3000K	160	540Lm	190Lm	154,00

FOLD 2

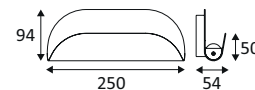
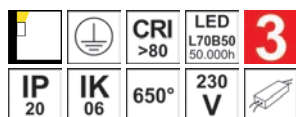

- Applique murale décorative.
- Eclairage indirect.
- Convertisseur non dimmable intégré dans l'appareil.

FOLD 2	COULEUR	MATIÈRE	P	T°	L(MM)	LED LUMEN	SYSTEM LUMEN	€
WA237WW30	BLANC MAT	ALUMINIUM	6,5W	3000K	250	450Lm	375Lm	182,00





MALTA 1

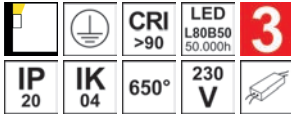

- Applique murale décorative.
- Eclairage indirect.
- Convertisseur non dimmable intégré dans l'appareil.

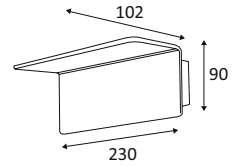

MALTA 1	COULEUR	MATIÈRE	P	T°	L(MM)	LED LUMEN	SYSTEM LUMEN	€
WA12930	BLANC MAT	ALUMINIUM	17W	3000K	230	1950Lm	1855Lm	239,00

MALTA 2

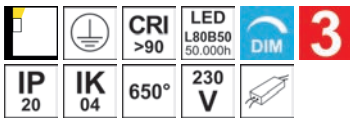

- Applique murale décorative.
- Eclairage indirect.
- Convertisseur dimmable intégré dans l'appareil.
- Compatible avec variateur fin de phase.

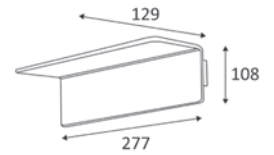

MALTA 2	COULEUR	MATIÈRE	P	T°	L(MM)	LED LUMEN	SYSTEM LUMEN	€
WA164WW30	BLANC MAT	ALUMINIUM	30W	3000K	129	3550Lm	3370Lm	273,00

LONGA

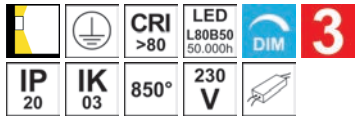

- Applique murale décorative.
- Eclairage «up&down».
- Convertisseur dimmable intégré dans l'appareil.
- Compatible avec variateur début et fin de phase.

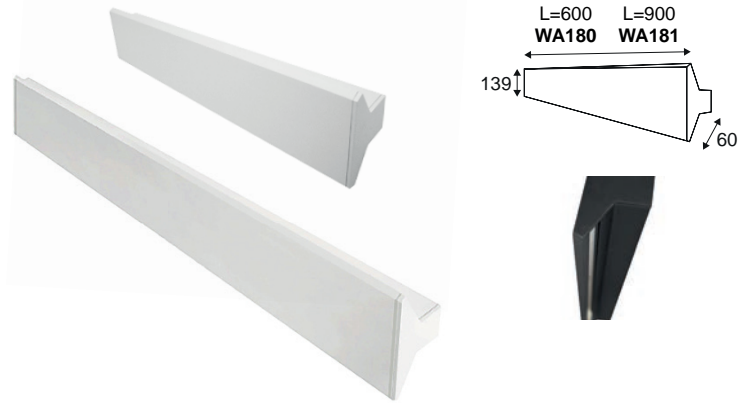

LONGA	COULEUR	MATIÈRE	P	T°	L(MM)	LED LUMEN	SYSTEM LUMEN	€
WA180WW05	■ NOIR MAT	ALUMINIUM	24W	3000K	600	2x2800Lm	5320Lm	284,00
WA180WW30	■ BLANC MAT	ALUMINIUM	24W	3000K	600	2x2800Lm	5320Lm	284,00
WA181WW05	■ NOIR MAT	ALUMINIUM	30W	3000K	900	2x3300Lm	6200Lm	346,00
WA181WW30	■ BLANC MAT	ALUMINIUM	30W	3000K	900	2x3300Lm	6200Lm	346,00



NOIR MAT

BLANC MAT



LONGA



PLANK 1

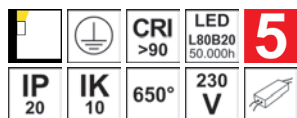

- Applique murale décorative.
- Diffuseur en polycarbonate opalin.
- Eclairage indirect.
- Convertisseur non dimmable intégré dans l'appareil.

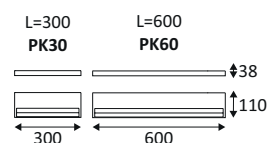
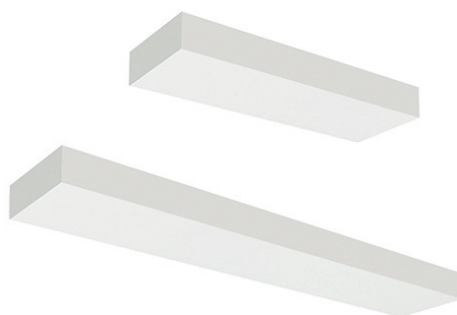

PLANK 1	COULEUR	MATIÈRE	P	T°	L(MM)	LED LUMEN	SYSTEM LUMEN	110°	€
PK30/1A/3K/W	BLANC MAT	ALUMINIUM	20W	3000K	300	2520Lm	1760Lm	110°	177,00
PK30/1A/4K/W	BLANC MAT	ALUMINIUM	20W	4000K	300	2730Lm	1910Lm	110°	177,00
PK60/1A/3K/W	BLANC MAT	ALUMINIUM	40W	3000K	600	5400Lm	3775Lm	110°	273,00
PK60/1A/4K/W	BLANC MAT	ALUMINIUM	40W	4000K	600	5850Lm	4090Lm	110°	273,00



BLANC MAT

BLANC MAT





PLANK 2

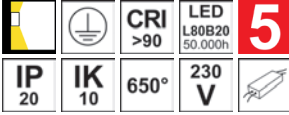

- Applique murale décorative.
- Diffuseurs en polycarbonate opalin.
- Eclairage direct/indirect.
- Convertisseur non dimmable intégré dans l'appareil.

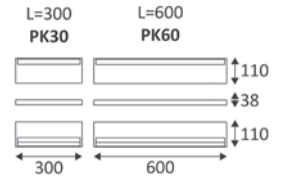

PLANK 2	COULEUR	MATIÈRE	P	T°	L(MM)	LED LUMEN	SYSTEM LUMEN	α	€
PK30/2A/3K/W	BLANC MAT	ALUMINIUM	32W	3000K	300	2x1980Lm	2210Lm	110°	187,00
PK30/2A/4K/W	BLANC MAT	ALUMINIUM	32W	4000K	300	2x2145Lm	2400Lm	110°	187,00
PK60/2A/3K/W	BLANC MAT	ALUMINIUM	64W	3000K	600	2x4030Lm	5640Lm	110°	298,00
PK60/2A/4K/W	BLANC MAT	ALUMINIUM	64W	4000K	600	2x4370Lm	6110Lm	110°	298,00



BLANC MAT

BLANC MAT



INDIGO

LIGHTING



PLAFONNIERS

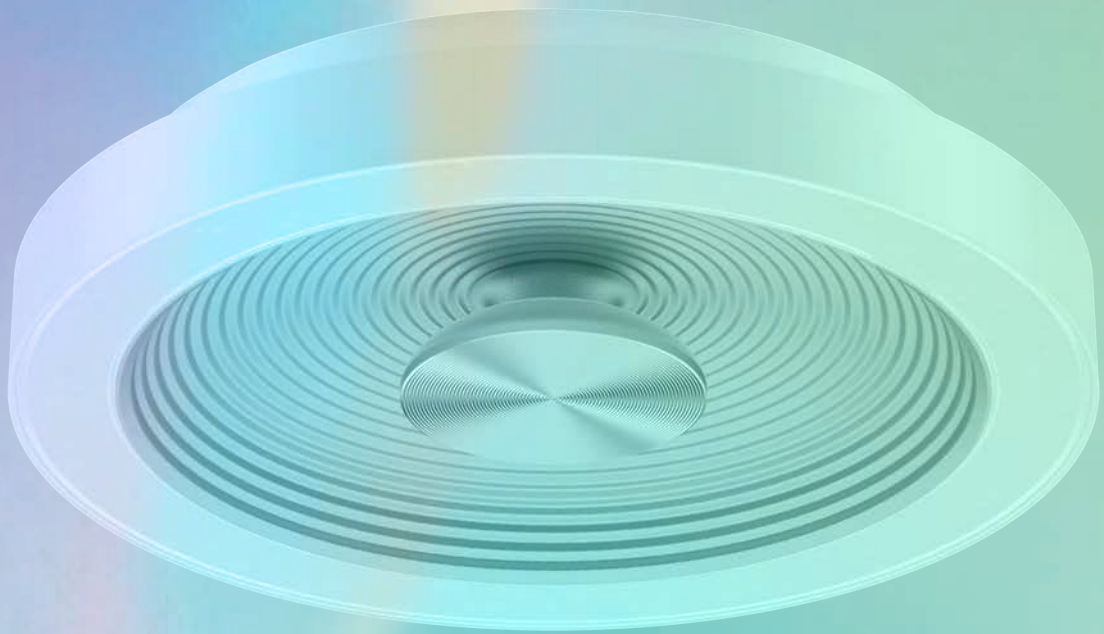

ALBA R GU10

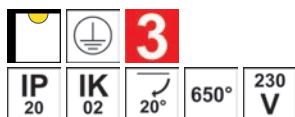

- Plafonnier rond orientable.

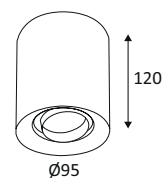

ALBA R GU10	COULEUR	MATIÈRE	SOQUET	LAMPE	WATT MAX	€
WA19505	■ NOIR MAT	ALUMINIUM	GU10	PAR16 LED	10W	61,00
WA19530	■ BLANC MAT	ALUMINIUM	GU10	PAR16 LED	10W	61,00



NOIR MAT



BLANC MAT

ALBA S GU10

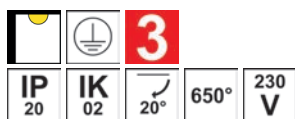

- Plafonnier carré orientable.

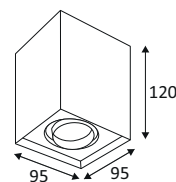
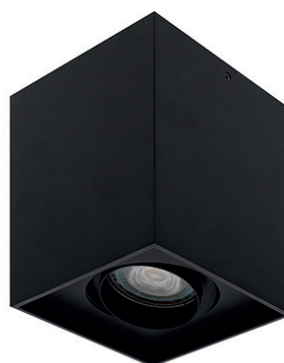

ALBA S GU10	COULEUR	MATIÈRE	SOQUET	LAMPE	WATT MAX	€
WA19605	■ NOIR MAT	ALUMINIUM	GU10	PAR16 LED	10W	78,00
WA19630	■ BLANC MAT	ALUMINIUM	GU10	PAR16 LED	10W	78,00



NOIR MAT



BLANC MAT



PLAFONNIERS

ALBA S GU10



LUPO 1 GU10

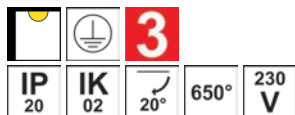

- Plafonnier carré orientable.

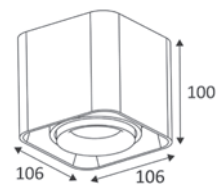

LUPO 1 GU10	COULEUR	MATIÈRE	SOQUET	LAMPE	WATT MAX	€
WA20305	NOIR MAT	ALUMINIUM	GU10	PAR16 LED	10W	78,00
WA20318	NOIR - DORÉ	ALUMINIUM	GU10	PAR16 LED	10W	78,00
WA20330	BLANC MAT	ALUMINIUM	GU10	PAR16 LED	10W	78,00



NOIR MAT

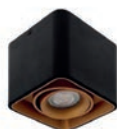

NOIR - DORÉ



BLANC MAT





PLAFONNIERS

MANYL 2 GU10

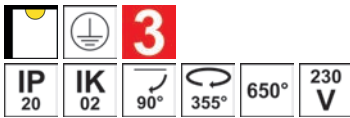

- Plafonnier rond orientable.

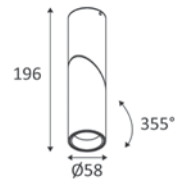

MANYL 2 GU10	COULEUR	MATIÈRE	SOQUET	LAMPE	WATT MAX	€
WA20205	■ NOIR MAT	ALUMINIUM	GU10	PAR16 LED	10W	113,00
WA20230	■ BLANC MAT	ALUMINIUM	GU10	PAR16 LED	10W	113,00



NOIR MAT



BLANC MAT

MANYL 2

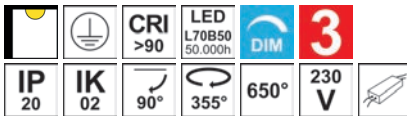

- Plafonnier rond orientable.
- Convertisseur dimmable intégré dans l'appareil.
- Compatible avec variateur début et fin de phase.

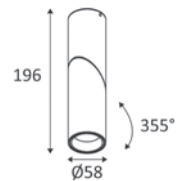

MANYL 2	COULEUR	MATIÈRE	P	T°	LED LUMEN	SYSTEM LUMEN	α	€
WA210WW16	■ NOIR MAT	ALUMINIUM	11W	3000K	1180Lm	940Lm	36°	177,00
WA210WW21	■ BLANC MAT	ALUMINIUM	11W	3000K	1180Lm	940Lm	36°	177,00



NOIR MAT



BLANC MAT

MOLY GU10

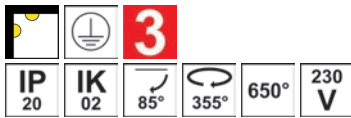

- Applique murale ou plafonnier rond orientable.

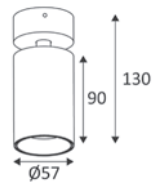

MOLY GU10	COULEUR	MATIÈRE	SOQUET	LAMPE	WATT MAX	€
WA19405	■ NOIR MAT	ALUMINIUM	GU10	PAR16 LED	10W	54,00
WA19430	■ BLANC MAT	ALUMINIUM	GU10	PAR16 LED	10W	54,00



NOIR MAT



BLANC MAT

NOLY GU10

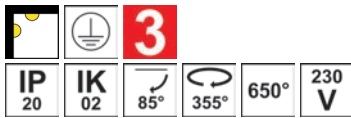

- Applique murale ou plafonnier orientable.

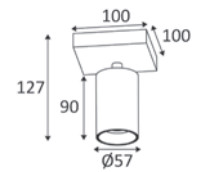

NOLY GU10	COULEUR	MATIÈRE	L(MM)	SOQUET	LAMPE	WATT MAX	€
WA19705	■ NOIR MAT	ALUMINIUM	100	GU10	PAR16 LED	10W	53,00
WA19730	■ BLANC MAT	ALUMINIUM	100	GU10	PAR16 LED	10W	53,00



NOIR MAT



BLANC MAT



PLAFONNIERS

YUKO GU10

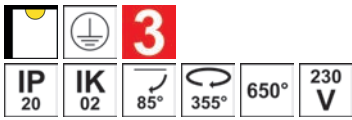

- Plafonnier rond orientable.

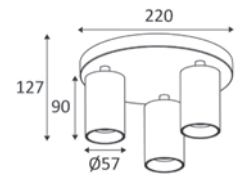

YUKO GU10	COULEUR	MATIÈRE	SOQUET	LAMPE	WATT MAX	€
WA19805	■ NOIR MAT	ALUMINIUM	GU10	PAR16 LED	3x10W	95,00
WA19830	■ BLANC MAT	ALUMINIUM	GU10	PAR16 LED	3x10W	95,00



NOIR MAT



BLANC MAT



OKTO GU10



- Plafonnier rond fixe.

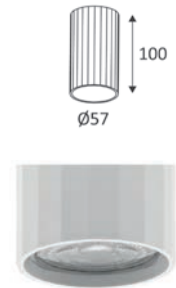

OKTO GU10	COULEUR	MATIÈRE	SOQUET	LAMPE	WATT MAX	€	
WA22905		NOIR MAT	ALUMINIUM	GU10	PAR16 LED	10W	36,00
WA22930		BLANC MAT	ALUMINIUM	GU10	PAR16 LED	10W	36,00
WA22910		CHAMPAGNE	ALUMINIUM	GU10	PAR16 LED	10W	38,00
WA22907		OR ROSE	ALUMINIUM	GU10	PAR16 LED	10W	38,00
WA22977		ROSE	ALUMINIUM	GU10	PAR16 LED	10W	39,00

DANS LA MÊME GAMME



NOIR MAT



BLANC MAT



CHAMPAGNE



OR ROSE



ROSE



OKTO RX GU10 PAGE 87



OKTO 2 GU10 PAGE 149



OKTO P GU10 PAGE 218





PLAFONNIERS

OKTO C GU10



- Applique murale ou plafonnier rond orientable.

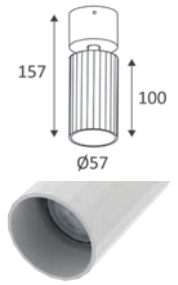

OKTO C GU10	COULEUR	MATIÈRE	SOQUET	LAMPE	WATT MAX	€
WA23005	NOIR MAT	ALUMINIUM	GU10	PAR16 LED	10W	58,00
WA23008	NOIR MAT - CHAMPAGNE	ALUMINIUM	GU10	PAR16 LED	10W	59,00
WA23006	NOIR MAT - OR ROSE	ALUMINIUM	GU10	PAR16 LED	10W	59,00
WA23083	NOIR MAT - ROSE	ALUMINIUM	GU10	PAR16 LED	10W	59,00
WA23030	BLANC MAT	ALUMINIUM	GU10	PAR16 LED	10W	58,00
WA23049	BLANC MAT - CHAMPAGNE	ALUMINIUM	GU10	PAR16 LED	10W	59,00
WA23002	BLANC MAT - OR ROSE	ALUMINIUM	GU10	PAR16 LED	10W	59,00
WA23082	BLANC MAT - ROSE	ALUMINIUM	GU10	PAR16 LED	10W	59,00

DANS LA MÊME GAMME



OKTO 1 C GU10

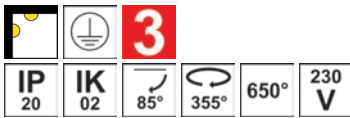

- Applique murale ou plafonnier rond orientable.

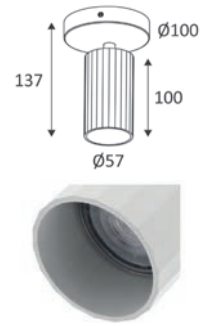

OKTO 1 C GU10	COULEUR	MATIÈRE	L(MM)	SOQUET	LAMPE	WATT MAX	€
WA23105	NOIR MAT	ALUMINIUM	100	GU10	PAR16 LED	10W	54,00
WA23108	NOIR MAT - CHAMPAGNE	ALUMINIUM	100	GU10	PAR16 LED	10W	58,00
WA23106	NOIR MAT - OR ROSE	ALUMINIUM	100	GU10	PAR16 LED	10W	58,00
WA23183	NOIR MAT - ROSE	ALUMINIUM	100	GU10	PAR16 LED	10W	58,00
WA23130	BLANC MAT	ALUMINIUM	100	GU10	PAR16 LED	10W	54,00
WA23149	BLANC MAT - CHAMPAGNE	ALUMINIUM	100	GU10	PAR16 LED	10W	58,00
WA23102	BLANC MAT - OR ROSE	ALUMINIUM	100	GU10	PAR16 LED	10W	58,00
WA23182	BLANC MAT - ROSE	ALUMINIUM	100	GU10	PAR16 LED	10W	58,00

DANS LA MÊME GAMME



NOIR MAT



NOIR MAT - CHAMPAGNE



NOIR MAT - OR ROSE



NOIR MAT - ROSE



OKTO RX GU10 PAGE 87



OKTO 2 GU10 PAGE 149



OKTO P GU10 PAGE 218



BLANC MAT



BLANC MAT - CHAMPAGNE



BLANC MAT - OR ROSE



BLANC MAT - ROSE





PLAFONNIERS

OKTO 2 C GU10

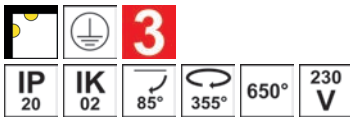

- Applique murale ou plafonnier orientable.

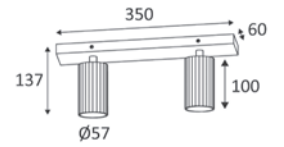

OKTO 2 C GU10	COULEUR	MATIÈRE	L(MM)	SOQUET	LAMPE	WATT MAX	€
WA23205	NOIR MAT	ALUMINIUM	350	GU10	PAR16 LED	2x10W	83,00
WA23208	NOIR MAT - CHAMPAGNE	ALUMINIUM	350	GU10	PAR16 LED	2x10W	88,00
WA23206	NOIR MAT - OR ROSE	ALUMINIUM	350	GU10	PAR16 LED	2x10W	88,00
WA23283	NOIR MAT - ROSE	ALUMINIUM	350	GU10	PAR16 LED	2x10W	88,00
WA23230	BLANC MAT	ALUMINIUM	350	GU10	PAR16 LED	2x10W	83,00
WA23249	BLANC MAT - CHAMPAGNE	ALUMINIUM	350	GU10	PAR16 LED	2x10W	88,00
WA23202	BLANC MAT - OR ROSE	ALUMINIUM	350	GU10	PAR16 LED	2x10W	88,00
WA23282	BLANC MAT - ROSE	ALUMINIUM	350	GU10	PAR16 LED	2x10W	88,00

DANS LA MÊME GAMME



NOIR MAT



NOIR MAT - CHAMPAGNE



NOIR MAT - OR ROSE



NOIR MAT - ROSE



OKTO RX GU10 PAGE 87



OKTO P GU10 PAGE 218



OKTO 2 GU10 PAGE 149



BLANC MAT



BLANC MAT - CHAMPAGNE



BLANC MAT - OR ROSE



BLANC MAT - ROSE

OKTO 4 C GU10

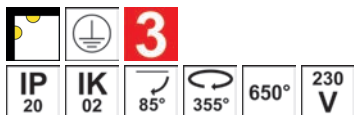

- Applique murale ou plafonnier orientable.

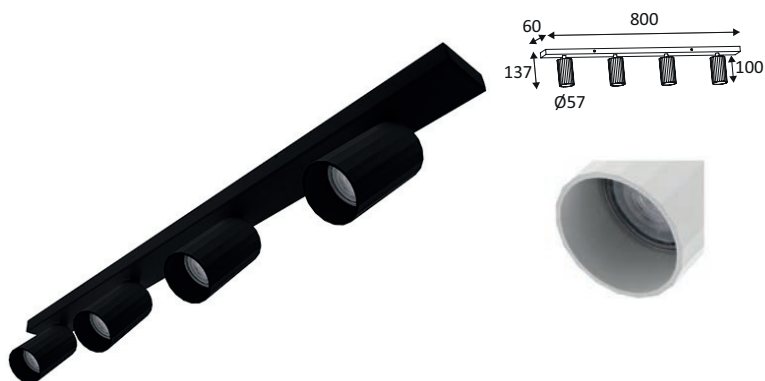

OKTO 4 C GU10	COULEUR	MATIÈRE	L(MM)	SOQUET	LAMPE	WATT MAX	€
WA23305	NOIR MAT	ALUMINIUM	800	GU10	PAR16 LED	4x10W	153,00
WA23308	NOIR MAT - CHAMPAGNE	ALUMINIUM	800	GU10	PAR16 LED	4x10W	164,00
WA23306	NOIR MAT - OR ROSE	ALUMINIUM	800	GU10	PAR16 LED	4x10W	164,00
WA23383	NOIR MAT - ROSE	ALUMINIUM	800	GU10	PAR16 LED	4x10W	161,00
WA23330	BLANC MAT	ALUMINIUM	800	GU10	PAR16 LED	4x10W	153,00
WA23349	BLANC MAT - CHAMPAGNE	ALUMINIUM	800	GU10	PAR16 LED	4x10W	164,00
WA23302	BLANC MAT - OR ROSE	ALUMINIUM	800	GU10	PAR16 LED	4x10W	164,00
WA23382	BLANC MAT - ROSE	ALUMINIUM	800	GU10	PAR16 LED	4x10W	164,00

DANS LA MÊME GAMME



OKTO RX GU10 PAGE 87



OKTO 2 GU10 PAGE 149



OKTO P GU10 PAGE 218

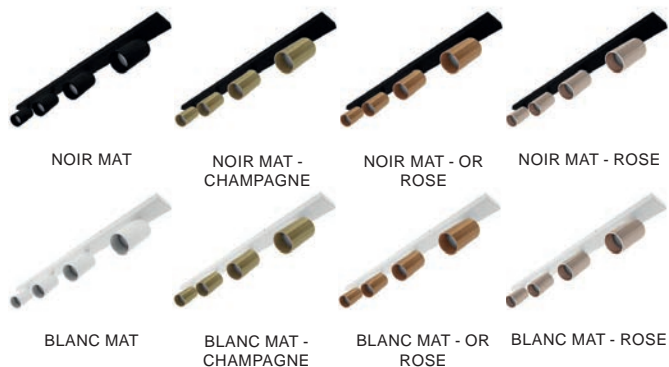



PLAFONNIERS

RIVA 2 GU10

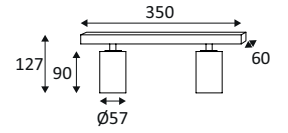
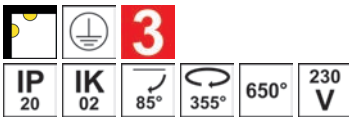

- Applique murale ou plafonnier orientable.

RIVA 2 GU10	COULEUR	MATIÈRE	L(MM)	SOQUET	LAMPE	WATT MAX	€
WA19905	■ NOIR MAT	ALUMINIUM	350	GU10	PAR16 LED	2x10W	88,00
WA19930	■ BLANC MAT	ALUMINIUM	350	GU10	PAR16 LED	2x10W	88,00



NOIR MAT



BLANC MAT

RIVA 3 GU10

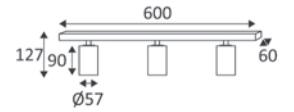
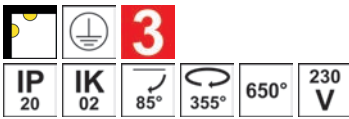

- Applique murale ou plafonnier orientable.

RIVA 3 GU10	COULEUR	MATIÈRE	L(MM)	SOQUET	LAMPE	WATT MAX	€
WA20005	■ NOIR MAT	ALUMINIUM	600	GU10	PAR16 LED	3x10W	118,00
WA20030	■ BLANC MAT	ALUMINIUM	600	GU10	PAR16 LED	3x10W	118,00



NOIR MAT



BLANC MAT

RIVA 4 GU10

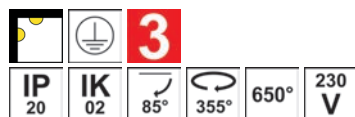

- Applique murale ou plafonnier orientable.

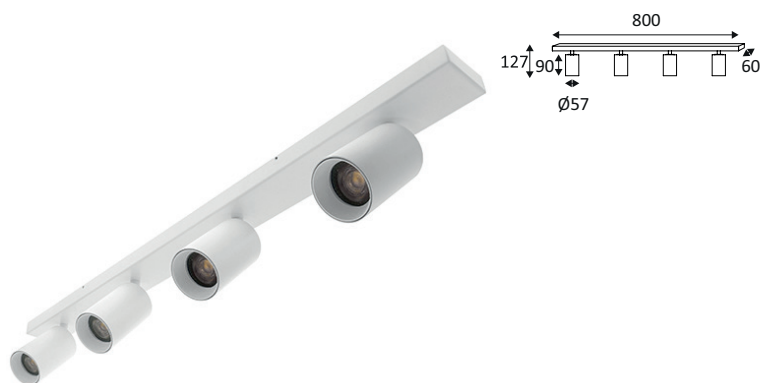

RIVA 4 GU10	COULEUR	MATIÈRE	L(MM)	SOQUET	LAMPE	WATT MAX	€
WA20105	■ NOIR MAT	ALUMINIUM	800	GU10	PAR16 LED	4x10W	154,00
WA20130	■ BLANC MAT	ALUMINIUM	800	GU10	PAR16 LED	4x10W	154,00



NOIR MAT

BLANC MAT





EVA 62 R

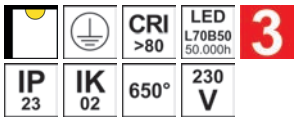

- Spot apparent rond.
- Ne nécessite pas de convertisseur.
- Non dimmable.

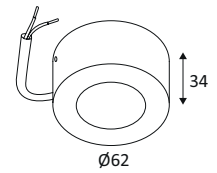

EVA 62 R	COULEUR	MATIÈRE	P	T°	LED LUMEN	SYSTEM LUMEN	α	€
DW1120R05	■ NOIR MAT	ALUMINIUM	8W	3000K	455Lm	335Lm	38°	79,00
DW1120R30	■ BLANC MAT	ALUMINIUM	8W	3000K	455Lm	335Lm	38°	79,00



NOIR MAT



BLANC MAT

EVA 62 S

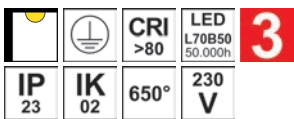

- Spot apparent carré.
- Ne nécessite pas de convertisseur.
- Non dimmable.

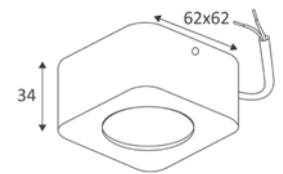

EVA 62 S	COULEUR	MATIÈRE	P	T°	L(MM)	LED LUMEN	SYSTEM LUMEN	α	€
DW1120S05	■ NOIR MAT	ALUMINIUM	8W	3000K	62	455Lm	335Lm	38°	80,00
DW1120S30	■ BLANC MAT	ALUMINIUM	8W	3000K	62	455Lm	335Lm	38°	80,00



NOIR MAT



BLANC MAT

HAPPY 1





PLAFONNIERS

HAPPY 1

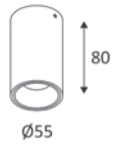
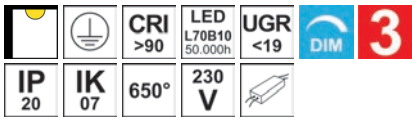

- Plafonnier rond fixe.
- Convertisseur dimmable intégré dans l'appareil.

HAPPY 1	COULEUR	MATIÈRE	P	T°	LED LUMEN	SYSTEM LUMEN	α	€
WA238WW05	NOIR MAT	ALUMINIUM	7W	3000K	600Lm	435Lm	40°	106,00
WA238WW08	NOIR MAT - CHAMPAGNE	ALUMINIUM	7W	3000K	600Lm	435Lm	40°	113,00
WA238WW17	NOIR MAT - ARGENT	ALUMINIUM	7W	3000K	600Lm	435Lm	40°	113,00
WA238WW23	NOIR MAT - CHROME NOIR	ALUMINIUM	7W	3000K	600Lm	435Lm	40°	113,00
WA238WW30	BLANC MAT	ALUMINIUM	7W	3000K	600Lm	435Lm	40°	106,00
WA238WW49	BLANC MAT - CHAMPAGNE	ALUMINIUM	7W	3000K	600Lm	435Lm	40°	113,00
WA238WW53	BLANC MAT - ARGENT	ALUMINIUM	7W	3000K	600Lm	435Lm	40°	113,00
WA238WW22	BLANC MAT - CHROME NOIR	ALUMINIUM	7W	3000K	600Lm	435Lm	40°	113,00



NOIR MAT



NOIR MAT - CHAMPAGNE



NOIR MAT - ARGENT



NOIR MAT - CHROME NOIR



BLANC MAT



BLANC MAT - CHAMPAGNE



BLANC MAT - ARGENT



BLANC MAT - CHROME NOIR



HAPPY 2

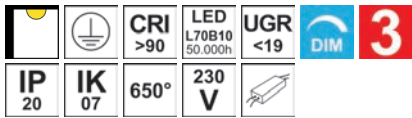

- Plafonnier rond fixe.
- Convertisseur dimmable intégré dans l'appareil.

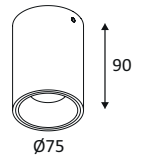

HAPPY 2	COULEUR	MATIÈRE	P	T°	LED LUMEN	SYSTEM LUMEN	α	€
WA239WW05	NOIR MAT	ALUMINIUM	13W	3000K	1155Lm	855Lm	40°	126,00
WA239WW08	NOIR MAT - CHAMPAGNE	ALUMINIUM	13W	3000K	1155Lm	855Lm	40°	138,00
WA239WW17	NOIR MAT - ARGENT	ALUMINIUM	13W	3000K	1155Lm	855Lm	40°	138,00
WA239WW23	NOIR MAT - CHROME NOIR	ALUMINIUM	13W	3000K	1155Lm	855Lm	40°	138,00
WA239WW30	BLANC MAT	ALUMINIUM	13W	3000K	1155Lm	855Lm	40°	126,00
WA239WW49	BLANC MAT - CHAMPAGNE	ALUMINIUM	13W	3000K	1155Lm	855Lm	40°	138,00
WA239WW53	BLANC MAT - ARGENT	ALUMINIUM	13W	3000K	1155Lm	855Lm	40°	138,00
WA239WW22	BLANC MAT - CHROME NOIR	ALUMINIUM	13W	3000K	1155Lm	855Lm	40°	138,00



NOIR MAT



NOIR MAT - CHAMPAGNE



NOIR MAT - ARGENT



NOIR MAT - CHROME NOIR



BLANC MAT



BLANC MAT - CHAMPAGNE



BLANC MAT - ARGENT



BLANC MAT - CHROME NOIR

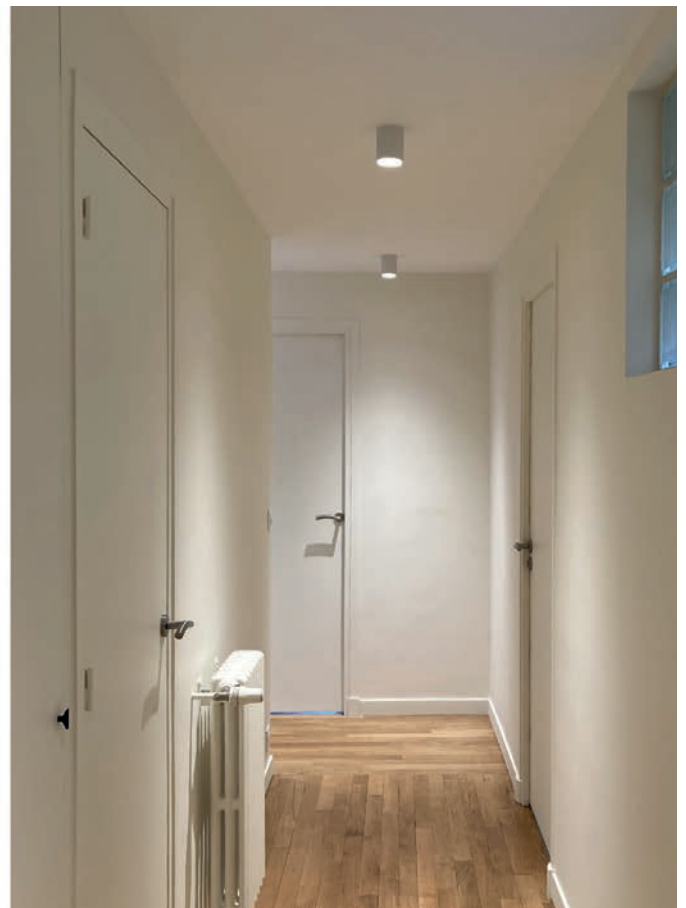



PLAFONNIERS

HAPPY 3

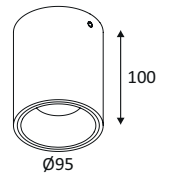
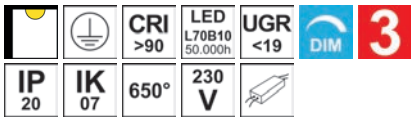

- Plafonnier rond fixe.
- Convertisseur dimmable intégré dans l'appareil.

HAPPY 3	COULEUR	MATIÈRE	P	T°	LED LUMEN	SYSTEM LUMEN	α	€
WA240WW05	NOIR MAT	ALUMINIUM	18W	3000K	1570Lm	1170Lm	40°	147,00
WA240WW08	NOIR MAT - CHAMPAGNE	ALUMINIUM	18W	3000K	1570Lm	1170Lm	40°	160,00
WA240WW17	NOIR MAT - ARGENT	ALUMINIUM	18W	3000K	1570Lm	1170Lm	40°	160,00
WA240WW23	NOIR MAT - CHROME NOIR	ALUMINIUM	18W	3000K	1570Lm	1170Lm	40°	160,00
WA240WW30	BLANC MAT	ALUMINIUM	18W	3000K	1570Lm	1170Lm	40°	147,00
WA240WW49	BLANC MAT - CHAMPAGNE	ALUMINIUM	18W	3000K	1570Lm	1170Lm	40°	160,00
WA240WW53	BLANC MAT - ARGENT	ALUMINIUM	18W	3000K	1570Lm	1170Lm	40°	160,00
WA240WW22	BLANC MAT - CHROME NOIR	ALUMINIUM	18W	3000K	1570Lm	1170Lm	40°	160,00



NOIR MAT



NOIR MAT - CHAMPAGNE



NOIR MAT - ARGENT



NOIR MAT - CHROME NOIR



BLANC MAT



BLANC MAT - CHAMPAGNE



BLANC MAT - ARGENT



BLANC MAT - CHROME NOIR



AUREA 1 C





AUREA 1 C

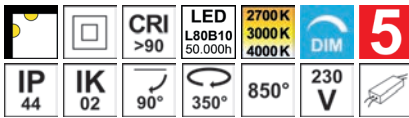

- Applique murale ou plafonnier rond orientable.
- 2700K, 3000K ou 4000K au choix via un interrupteur à l'arrière du luminaire.
- Convertisseur dimmable intégré dans l'appareil.
- Compatible avec variateur début de phase.

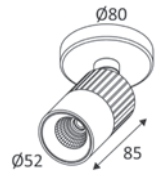

AUREA 1 C	COULEUR	MATIÈRE	P	T°	LED LUMEN	SYSTEM LUMEN	α	€
WA25605	NOIR MAT	ALUMINIUM	6W	2700K 3000K 4000K	715Lm (4000K)	550Lm (4000K)	38°	95,00
WA25608	NOIR MAT - CHAMPAGNE	ALUMINIUM	6W	2700K 3000K 4000K	715Lm (4000K)	550Lm (4000K)	38°	107,00
WA25683	NOIR MAT - ROSE	ALUMINIUM	6W	2700K 3000K 4000K	715Lm (4000K)	550Lm (4000K)	38°	107,00
WA25630	BLANC MAT	ALUMINIUM	6W	2700K 3000K 4000K	715Lm (4000K)	550Lm (4000K)	38°	95,00
WA25649	BLANC MAT - CHAMPAGNE	ALUMINIUM	6W	2700K 3000K 4000K	715Lm (4000K)	550Lm (4000K)	38°	107,00
WA25682	BLANC MAT - ROSE	ALUMINIUM	6W	2700K 3000K 4000K	715Lm (4000K)	550Lm (4000K)	38°	107,00



NOIR MAT

NOIR MAT -
CHAMPAGNE

NOIR MAT - ROSE



BLANC MAT

BLANC MAT -
CHAMPAGNE

BLANC MAT - ROSE

DANS LA MÊME GAMME



AUREA P PAGE 219



AUREA 4 W PAGE 157



AUREA 3 W PAGE 156



AUREA 2 W PAGE 155



AUREA 1 W PAGE 154

AUREA 2 C

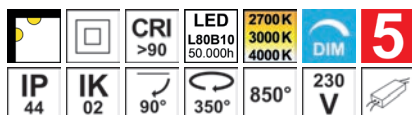

- Applique murale ou plafonnier orientable.
- 2700K, 3000K ou 4000K au choix via un interrupteur à l'arrière du luminaire.
- Convertisseur dimmable intégré dans l'appareil.
- Compatible avec variateur début de phase.

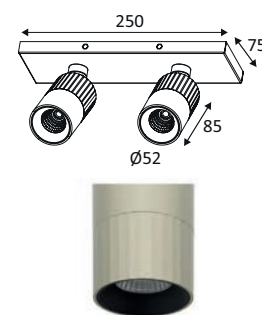

AUREA 2 C	COULEUR	MATIÈRE	P	T°	L(MM)	LED LUMEN	SYSTEM LUMEN	α	€
WA25705	■ NOIR MAT	ALUMINIUM	12W	2700K 3000K 4000K	250	715Lm (4000K)	1100Lm (4000K)	38°	193,00
WA25708	■ NOIR MAT - CHAMPAGNE	ALUMINIUM	12W	2700K 3000K 4000K	250	715Lm (4000K)	1100Lm (4000K)	38°	215,00
WA25783	■ NOIR MAT - ROSE	ALUMINIUM	12W	2700K 3000K 4000K	250	715Lm (4000K)	1100Lm (4000K)	38°	215,00
WA25730	■ BLANC MAT	ALUMINIUM	12W	2700K 3000K 4000K	250	715Lm (4000K)	1100Lm (4000K)	38°	193,00
WA25749	■ BLANC MAT - CHAMPAGNE	ALUMINIUM	12W	2700K 3000K 4000K	250	715Lm (4000K)	1100Lm (4000K)	38°	215,00
WA25782	■ BLANC MAT - ROSE	ALUMINIUM	12W	2700K 3000K 4000K	250	715Lm (4000K)	1100Lm (4000K)	38°	215,00



NOIR MAT

NOIR MAT -
CHAMPAGNE

NOIR MAT - ROSE



BLANC MAT

BLANC MAT -
CHAMPAGNE

BLANC MAT - ROSE

DANS LA MÊME GAMME



AUREA P PAGE 219



AUREA 4 W PAGE 157



AUREA 3 W PAGE 156



AUREA 2 W PAGE 155



AUREA 1 W PAGE 154



PLAFONNIERS

CLAC 1 MINI

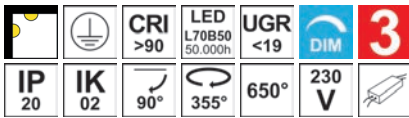

- Applique murale ou plafonnier rond orientable.
- Convertisseur dimmable intégré dans l'appareil.
- Compatible avec variateur fin de phase.

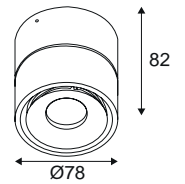

CLAC 1 MINI	COULEUR	MATIÈRE	P	T°	LED LUMEN	SYSTEM LUMEN	α	€
WA182SW05	NOIR MAT	ALUMINIUM	8W	2700K	710Lm	435Lm	38°	129,00
WA182SW30	BLANC MAT	ALUMINIUM	8W	2700K	710Lm	435Lm	38°	129,00
WA182WW05	NOIR MAT	ALUMINIUM	9W	3000K	930Lm	600Lm	38°	134,00
WA182WW30	BLANC MAT	ALUMINIUM	9W	3000K	930Lm	655Lm	38°	134,00

DANS LA MÊME GAMME



NOIR MAT



BLANC MAT



CLIC RDX MINI PAGE 92

CLAC 2 MINI

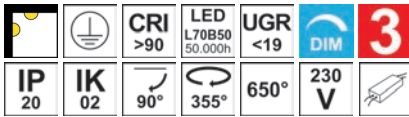

- Applique murale ou plafonnier orientable.
- Convertisseur dimmable intégré dans l'appareil.
- Compatible avec variateur fin de phase.

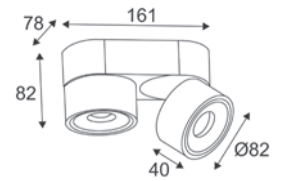

CLAC 2 MINI	COULEUR	MATIÈRE	P	T°	L(MM)	LED LUMEN	SYSTEM LUMEN	α	€
WA183SW05	NOIR MAT	ALUMINIUM	16W	2700K	161	2x710Lm	870Lm	38°	188,00
WA183SW30	BLANC MAT	ALUMINIUM	18W	2700K	161	2x920Lm	1230Lm	38°	188,00
WA183WW05	NOIR MAT	ALUMINIUM	18W	3000K	161	2x930Lm	1200Lm	38°	198,00
WA183WW30	BLANC MAT	ALUMINIUM	18W	3000K	161	2x930Lm	1310Lm	38°	198,00

DANS LA MÊME GAMME



NOIR MAT



BLANC MAT



CLIC RDX MINI 92

CLAC

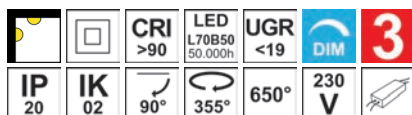

- Applique murale ou plafonnier rond orientable.
- Convertisseur dimmable intégré dans l'appareil.
- Compatible avec variateur fin de phase.

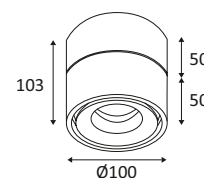

CLAC	COULEUR	MATIÈRE	P	T°	LED LUMEN	SYSTEM LUMEN	α	€
DO225SW05	NOIR MAT	ALUMINIUM	13W	2700K	1520Lm	865Lm	38°	198,00
DO225SW30	BLANC MAT	ALUMINIUM	13W	2700K	1120Lm	800Lm	38°	198,00
DO225WW05	NOIR MAT	ALUMINIUM	13W	3000K	1570Lm	900Lm	38°	198,00
DO225WW30	BLANC MAT	ALUMINIUM	13W	3000K	1570Lm	1010Lm	38°	198,00
DO225WW64	CUIVRE MAT	ALUMINIUM	13W	3000K	1180Lm	900Lm	38°	222,00

DANS LA MÊME GAMME



NOIR MAT



BLANC MAT



CUIVRE MAT



CLIC RDX PAGE 92





PLAFONNIERS

AUREA 1 C

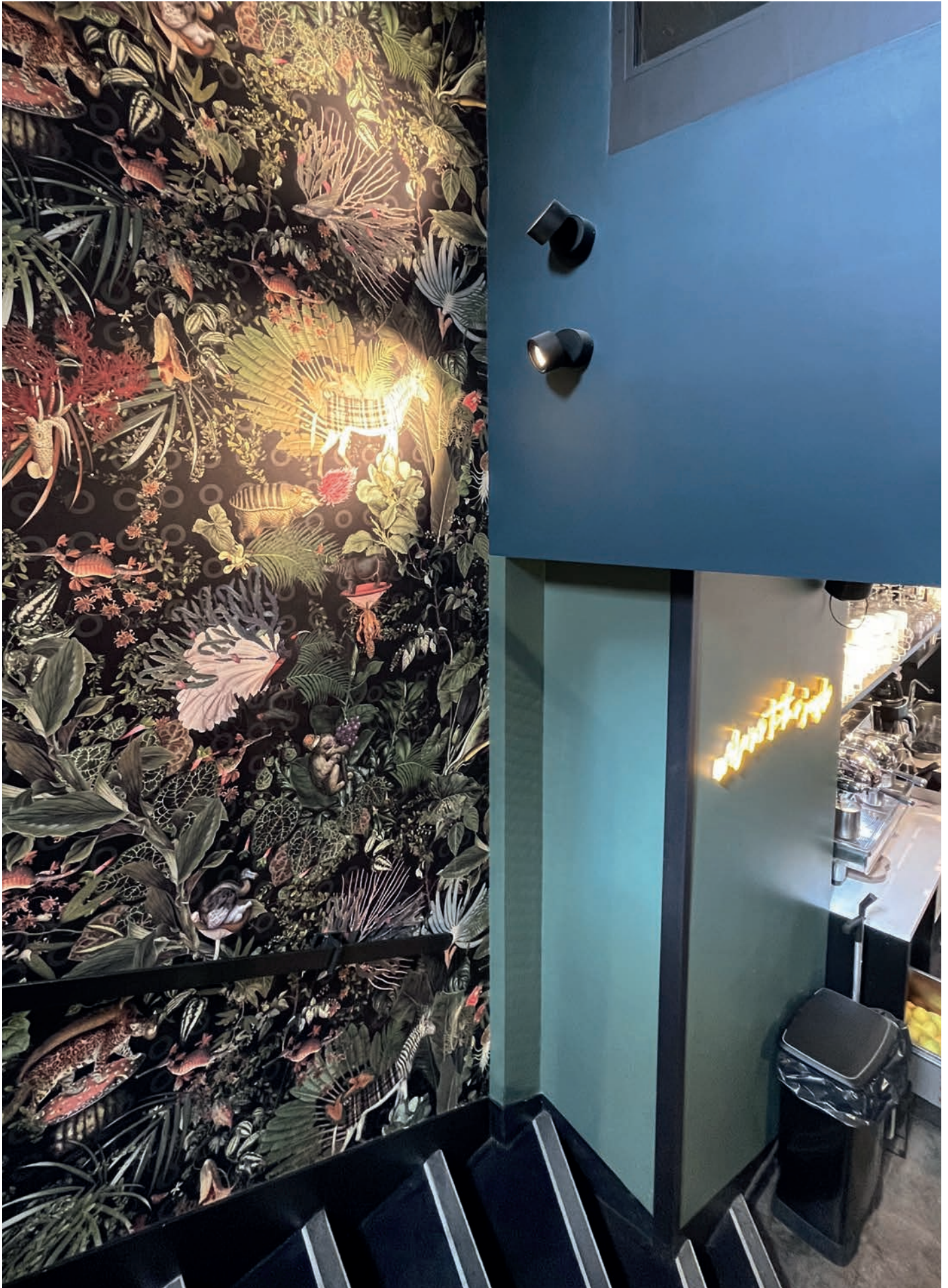

PIXA 1

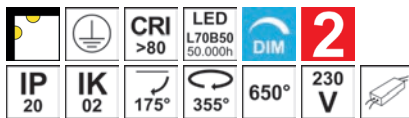

- Applique murale ou plafonnier orientable.
- Convertisseur dimmable intégré dans l'appareil.
- Compatible avec variateur fin de phase.

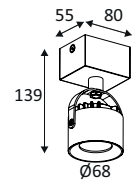

PIXA 1	COULEUR	MATIÈRE	P	T°	L(MM)	LED LUMEN	SYSTEM LUMEN	α	€
WA13205	■ NOIR MAT	FONTE D'ALUMINIUM	10W	3000K	80	1200Lm	745Lm	38°	177,00
WA13230	■ BLANC MAT	FONTE D'ALUMINIUM	10W	3000K	80	1200Lm	745Lm	38°	177,00



NOIR MAT



BLANC MAT

PIXA 2

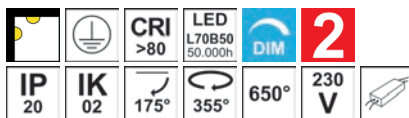

- Applique murale ou plafonnier orientable.
- Convertisseur dimmable intégré dans l'appareil.
- Compatible avec variateur fin de phase.

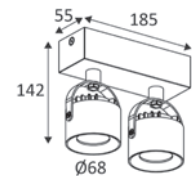

PIXA 2	COULEUR	MATIÈRE	P	T°	L(MM)	LED LUMEN	SYSTEM LUMEN	α	€
WA13305	■ NOIR MAT	FONTE D'ALUMINIUM	20W	3000K	185	2x1200Lm	1490Lm	38°	286,00
WA13330	■ BLANC MAT	FONTE D'ALUMINIUM	20W	3000K	185	2x1200Lm	1490Lm	38°	286,00



NOIR MAT



BLANC MAT



PLAFONNIERS

PIXA 3

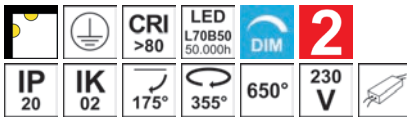

- Applique murale ou plafonnier orientable.
- Convertisseur dimmable intégré dans l'appareil.
- Compatible avec variateur fin de phase.

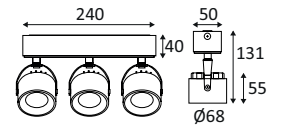

PIXA 3	COULEUR	MATIÈRE	P	T°	L(MM)	LED LUMEN	SYSTEM LUMEN	α	€
WA13405	■ NOIR MAT	FONTE D'ALUMINIUM	30W	3000K	240	3x1200Lm	2230Lm	38°	414,00
WA13430	■ BLANC MAT	FONTE D'ALUMINIUM	30W	3000K	240	3x1200Lm	2230Lm	38°	414,00



NOIR MAT



BLANC MAT

PIXA 2



TIPO 1 C

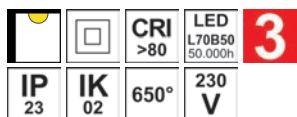

- Plafonnier extra-plat rond.
- Ne nécessite pas de convertisseur.
- Non dimmable.

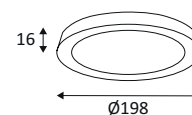

TIPO 1 C	COULEUR	MATIÈRE	P	T°	LED LUMEN	SYSTEM LUMEN	α	€
DO263WW30	BLANC MAT	COMPOSITE	18W	3000K	1350Lm	1000Lm	110°	78,00
DO263NW30	BLANC MAT	COMPOSITE	18W	4000K	1400Lm	1040Lm	110°	78,00

TIPO 2 C



- Plafonnier extra-plat rond.
- Ne nécessite pas de convertisseur.
- Non dimmable.

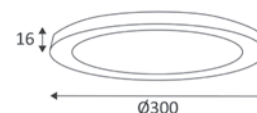

TIPO 2 C	COULEUR	MATIÈRE	P	T°	LED LUMEN	SYSTEM LUMEN	α	€
WA179WW30	BLANC MAT	COMPOSITE	24W	3000K	1950Lm	1500Lm	110°	90,00
WA179NW30	BLANC MAT	COMPOSITE	24W	4000K	2100Lm	1620Lm	110°	90,00



PLAFONNIERS

TIPO 2 C



HULA C

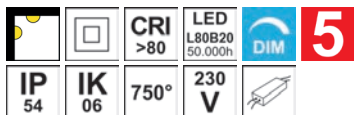

- Applique murale ou plafonnier décoratif.
- Eclairage direct diffus via l'anneau externe et indirect via le réflecteur au design ondulé créant une ambiance agréable.
- Convertisseur dimmable intégré dans l'appareil.
- Compatible avec variateur début et fin de phase.
- Entrée de câble supérieure ou latérale.

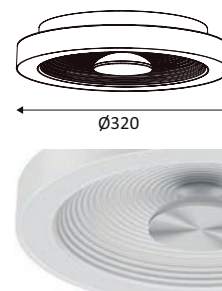
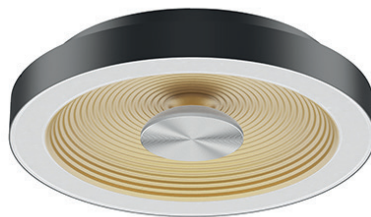

HULA C		COULEUR	MATIÈRE	P	T°	LED LUMEN	SYSTEM LUMEN	α	€
AIN3KCLBKWH	NEW	NOIR MAT - BLANC MAT	PLASTIQUE	18W	3000K	1850Lm	1000Lm	120°	119,00
AIN3KCLBKGD	NEW	NOIR MAT - DORÉ	PLASTIQUE	18W	3000K	1850Lm	1000Lm	120°	119,00
AIN3KCLHWHH	NEW	BLANC MAT	PLASTIQUE	18W	3000K	1850Lm	1000Lm	120°	119,00
AIN3KCLWHGD	NEW	BLANC MAT - DORÉ	PLASTIQUE	18W	3000K	1850Lm	1000Lm	120°	119,00

DANS LA MÊME GAMME



HULA P PAGE 227

NOIR MAT - BLANC
MAT

NOIR MAT - DORÉ

BLANC MAT

BLANC MAT - DORÉ



HULA C



- Réflecteur au design ondulé donnant un cachet à la décoration.
- Déclinable en différentes formes et combinaisons de couleurs.
- Dimmable.

JUNE 1 C

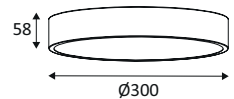
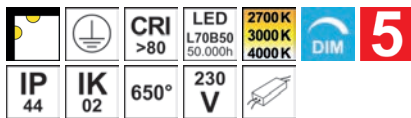

- Applique murale ou plafonnier décoratif.
- Diffuseur en PS opalin.
- 2700K, 3000K ou 4000K au choix via un interrupteur dans le luminaire.
- Convertisseur dimmable intégré dans l'appareil.
- Compatible avec variateur début et fin de phase.



JUNE 1 C	COULEUR	MATIÈRE	P	T°	LED LUMEN	SYSTEM LUMEN	α	€
WA22205	■ NOIR MAT	ALUMINIUM	18W	2700K 3000K 4000K	3300Lm (4000K)	1775Lm (4000K)	120°	115,00
WA22230	■ BLANC MAT	ALUMINIUM	18W	2700K 3000K 4000K	3300Lm (4000K)	1775Lm (4000K)	120°	115,00

DANS LA MÊME GAMME



JUNE 1 P PAGE 228

NOIR MAT

BLANC MAT

JUNE 2 C

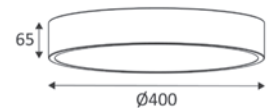
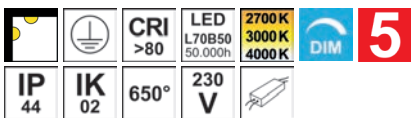

- Applique murale ou plafonnier décoratif.
- Diffuseur en PS opalin.
- 2700K, 3000K ou 4000K au choix via un interrupteur dans le luminaire.
- Convertisseur dimmable intégré dans l'appareil.
- Compatible avec variateur début et fin de phase.



JUNE 2 C	COULEUR	MATIÈRE	P	T°	LED LUMEN	SYSTEM LUMEN	α	€
WA22305	■ NOIR MAT	ALUMINIUM	30W	2700K 3000K 4000K	5600Lm (4000K)	3325Lm (4000K)	120°	186,00
WA22330	■ BLANC MAT	ALUMINIUM	30W	2700K 3000K 4000K	5600Lm (4000K)	3325Lm (4000K)	120°	186,00

DANS LA MÊME GAMME



JUNE 2 P PAGE 228

NOIR MAT

BLANC MAT



JUNE 3 C

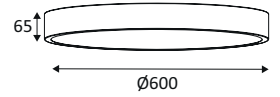
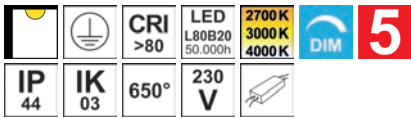

- Plafonnier décoratif.
- Diffuseur en PS opalin.
- 2700K, 3000K ou 4000K au choix via un interrupteur dans le luminaire.
- Convertisseur dimmable intégré dans l'appareil.
- Compatible avec variateur début et fin de phase.

JUNE 3 C	COULEUR	MATIÈRE	P	T°	LED LUMEN	SYSTEM LUMEN	α	€
WA24105	■ NOIR MAT	ALUMINIUM	50W	2700K 3000K 4000K	8000Lm (4000K)	5920Lm (4000K)	120°	283,00
WA24130	■ BLANC MAT	ALUMINIUM	50W	2700K 3000K 4000K	8000Lm (4000K)	5920Lm (4000K)	120°	283,00

DANS LA MÊME GAMME



NOIR MAT



BLANC MAT



JUNE 3 P PAGE 229

JUNE 2 C



CAPRI R 1 C



- Applique murale ou plafonnier.
- Diffuseur PS à structure prismatique.
- 2700K, 3000K ou 4000K au choix via un interrupteur dans le luminaire.
- Convertisseur dimmable coupure de phase ou dimmable DALI-push intégré dans l'appareil.

CAPRI R 1 C	COULEUR	MATIÈRE	P	T°	LED LUMEN	SYSTEM LUMEN	α	€
DIMMABLE COUPURE DE PHASE								
WA21605	■ NOIR MAT	ALUMINIUM	20W	2700K 3000K 4000K	2400Lm (4000K)	1360Lm (4000K)	90°	236,00
WA21630	■ BLANC MAT	ALUMINIUM	20W	2700K 3000K 4000K	2400Lm (4000K)	1360Lm (4000K)	90°	236,00
DIMMABLE DALI								
WA21605DA	■ NOIR MAT	ALUMINIUM	20W	2700K 3000K 4000K	2400Lm (4000K)	1360Lm (4000K)	90°	342,00
WA21630DA	■ BLANC MAT	ALUMINIUM	20W	2700K 3000K 4000K	2400Lm (4000K)	1360Lm (4000K)	90°	368,00

DANS LA MÊME GAMME



NOIR MAT

BLANC MAT



CAPRI R 1 P PAGE 230





CAPRI R 2 C

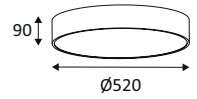

- Applique murale ou plafonnier.
- Diffuseur PS à structure prismatique.
- 2700K, 3000K ou 4000K au choix via un interrupteur dans le luminaire.
- Convertisseur dimmable coupure de phase ou dimmable DALI-push intégré dans l'appareil.

CAPRI R 2 C	COULEUR	MATIÈRE	P	T°	LED LUMEN	SYSTEM LUMEN	α	€
DIMMABLE COUPURE DE PHASE								
WA21705	■ NOIR MAT	ALUMINIUM	42W	2700K 3000K 4000K	5150Lm (4000K)	2910Lm (4000K)	90°	370,00
WA21730	■ BLANC MAT	ALUMINIUM	42W	2700K 3000K 4000K	5150Lm (4000K)	2910Lm (4000K)	90°	370,00
DIMMABLE DALI								
WA21705DA	■ NOIR MAT	ALUMINIUM	42W	2700K 3000K 4000K	5150Lm (4000K)	2910Lm (4000K)	90°	501,00
WA21730DA	■ BLANC MAT	ALUMINIUM	42W	2700K 3000K 4000K	5150Lm (4000K)	2910Lm (4000K)	90°	501,00

DANS LA MÊME GAMME



NOIR MAT



BLANC MAT



CAPRI R 2 P PAGE 230



CAPRI R 3 C

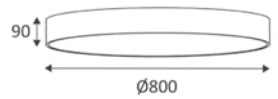

- Applique murale ou plafonnier.
- Diffuseur PS à structure prismatique.
- 2700K, 3000K ou 4000K au choix via un interrupteur dans le luminaire.
- Convertisseur dimmable DALI intégré dans l'appareil.

CAPRI R 3 C	COULEUR	MATIÈRE	P	T°	LED LUMEN	SYSTEM LUMEN	α	€
DIMMABLE DALI								
WA21805DA	■ NOIR MAT	ALUMINIUM	105W	2700K 3000K 4000K	11800Lm (4000K)	7070Lm (4000K)	90°	1157,00
WA21830DA	■ BLANC MAT	ALUMINIUM	105W	2700K 3000K 4000K	11800Lm (4000K)	7070Lm (4000K)	90°	1157,00



NOIR MAT

BLANC MAT

DANS LA MÊME GAMME



CAPRI R 3 P PAGE 231

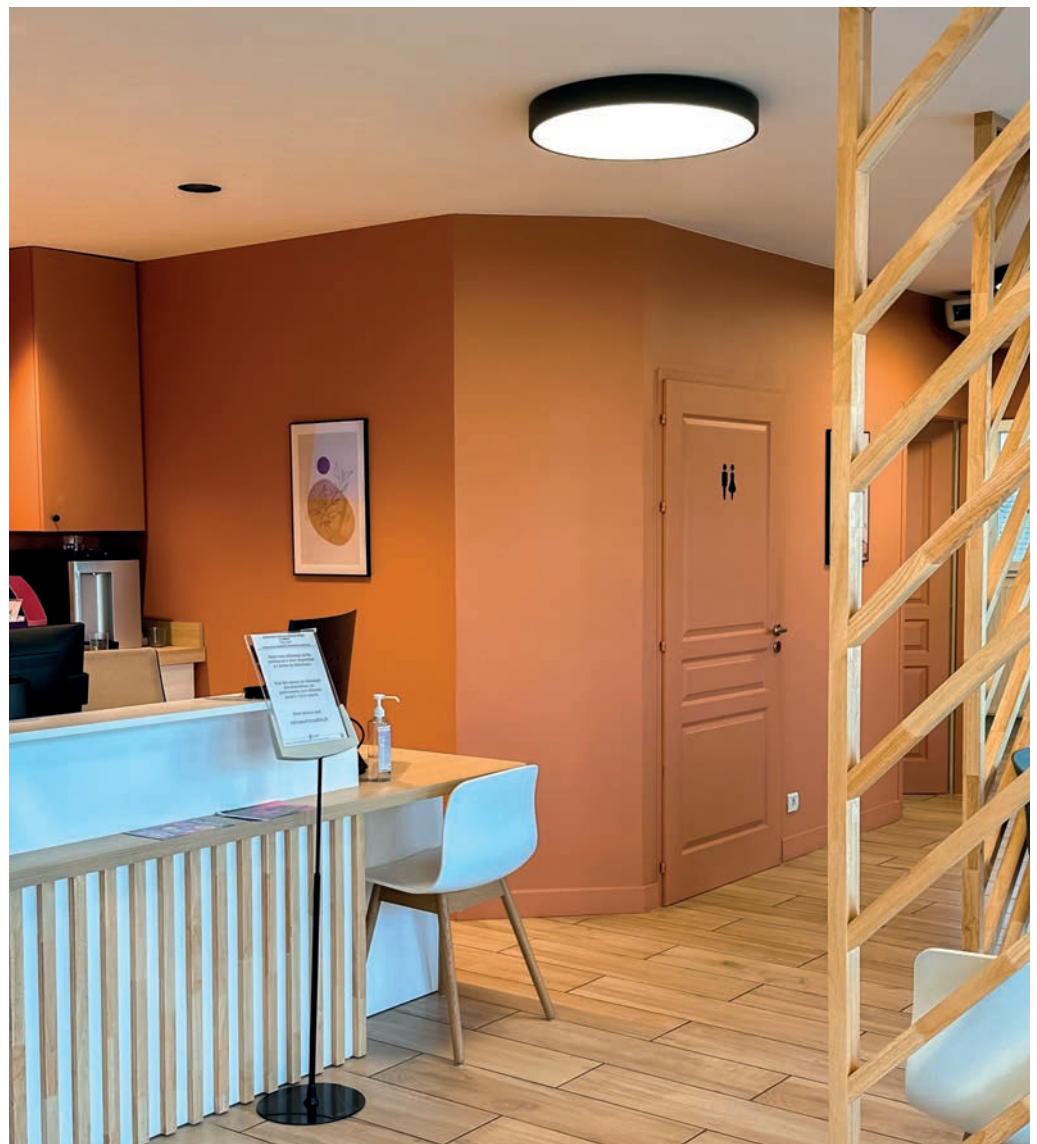



PLAFONNIERS

CAPRI S 1 C

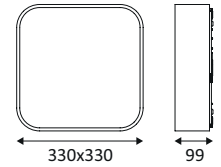

- Applique murale ou plafonnier.
- Diffuseur PS à structure prismatique.
- 2700K, 3000K ou 4000K au choix via un interrupteur dans le luminaire.
- Convertisseur dimmable coupe de phase ou dimmable DALI-push intégré dans l'appareil.

CAPRI S 1 C	COULEUR	MATIÈRE	P	T°	L(MM)	LED LUMEN	SYSTEM LUMEN	α	€
DIMMABLE COUPE DE PHASE									
WA24205	■ NOIR MAT	ALUMINIUM	20W	2700K 3000K 4000K	330	2400Lm (4000K)	1335Lm (4000K)	90°	258,00
WA24230	■ BLANC MAT	ALUMINIUM	20W	2700K 3000K 4000K	330	2400Lm (4000K)	1335Lm (4000K)	90°	258,00
DIMMABLE DALI									
WA24205DA	■ NOIR MAT	ALUMINIUM	20W	2700K 3000K 4000K	330	2400Lm (4000K)	1335Lm (4000K)	90°	373,00
WA24230DA	■ BLANC MAT	ALUMINIUM	20W	2700K 3000K 4000K	330	2400Lm (4000K)	1335Lm (4000K)	90°	373,00

DANS LA MÊME GAMME



CAPRI S 1 P PAGE 232



NOIR MAT

BLANC MAT

CAPRI S 2 C

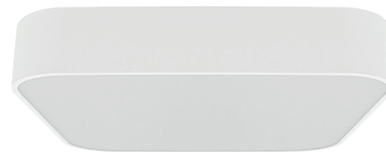
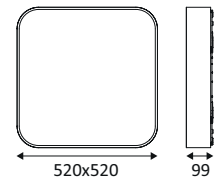

- Applique murale ou plafonnier.
- Diffuseur PS à structure prismatique.
- 2700K, 3000K ou 4000K au choix via un interrupteur dans le luminaire.
- Convertisseur dimmable coupe de phase ou dimmable DALI-push intégré dans l'appareil.

CAPRI S 2 C	COULEUR	MATIÈRE	P	T°	L(MM)	LED LUMEN	SYSTEM LUMEN	α	€
DIMMABLE COUPE DE PHASE									
WA24305	■ NOIR MAT	ALUMINIUM	42W	2700K 3000K 4000K	520	5150Lm (4000K)	3175Lm (4000K)	90°	404,00
WA24330	■ BLANC MAT	ALUMINIUM	42W	2700K 3000K 4000K	520	5150Lm (4000K)	3175Lm (4000K)	90°	404,00
DIMMABLE DALI									
WA24305DA	■ NOIR MAT	ALUMINIUM	42W	2700K 3000K 4000K	520	5150Lm (4000K)	3175Lm (4000K)	90°	546,00
WA24330DA	■ BLANC MAT	ALUMINIUM	42W	2700K 3000K 4000K	520	5150Lm (4000K)	3175Lm (4000K)	90°	546,00

DANS LA MÊME GAMME



CAPRI S 2 P PAGE 232



NOIR MAT

BLANC MAT

NOVA CSP 1 C

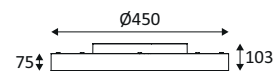
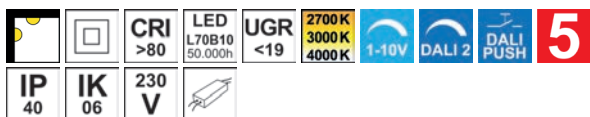

- Applique murale ou plafonnier rond.
- Diffuseur microprismatique.
- 2700K, 3000K ou 4000K au choix via un interrupteur dans le luminaire.
- Convertisseur dimmable DALI, Push-Dim et 1-10V intégré dans l'appareil.
- Kit d'éclairage indirect non-dimmable en option.



NOVA CSP 1 C	COULEUR	MATIÈRE	P	T°	LED LUMEN	SYSTEM LUMEN	α	€
NVB45DS	NOIR MAT - DORÉ	ALUMINIUM	26W	2700K 3000K 4000K	3930Lm (4000K)	3000Lm (4000K)	120°	561,00
NVW45DS	BLANC MAT - DORÉ	ALUMINIUM	26W	2700K 3000K 4000K	3930Lm (4000K)	3000Lm (4000K)	120°	561,00

ACCESSOIRES	MATIÈRE	DESCRIPTION	€
NV45UPM	POLYCARBONATE	KIT UPLIGHT 13W 3000K 1100Lm	124,00

DANS LA MÊME GAMME

NOVA CSP 1 P PAGE 234



NOIR MAT - DORÉ BLANC MAT - DORÉ

NOVA CSP 2 C



- Applique murale ou plafonnier rond.
- Diffuseur microprismatique.
- 2700K, 3000K ou 4000K au choix via un interrupteur dans le luminaire.
- Convertisseur dimmable DALI, Push-Dim et 1-10V intégré dans l'appareil.
- Kit d'éclairage indirect non-dimmable en option.

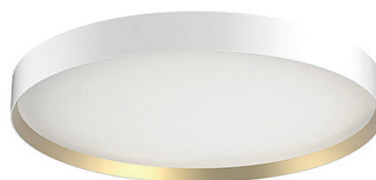

NOVA CSP 2 C	COULEUR	MATIÈRE	P	T°	LED LUMEN	SYSTEM LUMEN	α	€
NVB60DS	NOIR MAT - DORÉ	ALUMINIUM	40W	2700K 3000K 4000K	6075Lm (4000K)	4800Lm (4000K)	120°	762,00
NVW60DS	BLANC MAT - DORÉ	ALUMINIUM	40W	2700K 3000K 4000K	6075Lm (4000K)	4800Lm (4000K)	120°	762,00

ACCESSOIRES	MATIÈRE	DESCRIPTION	€
NV60UPM	POLYCARBONATE	KIT UPLIGHT 20W 3000K 1700Lm	181,00

DANS LA MÊME GAMME

NOVA CSP 2 P PAGE 234



NOIR MAT - DORÉ BLANC MAT - DORÉ



NOVA CSP 3 C

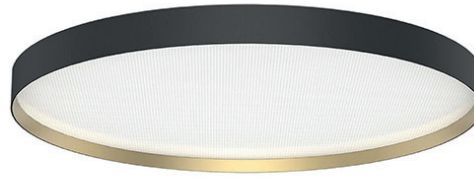
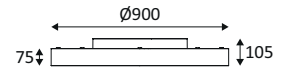

- Plafonnier rond.
- Diffuseur microprismatique.
- 2700K, 3000K ou 4000K au choix via un interrupteur dans le luminaire.
- Convertisseur dimmable DALI, Push-Dim et 1-10V intégré dans l'appareil.
- Kit d'éclairage indirect non-dimmable en option.

NOVA CSP 3 C	COULEUR	MATIÈRE	P	T°	LED LUMEN	SYSTEM LUMEN	α	€
NVB90DS	NOIR MAT - DORÉ	ALUMINIUM	68W	2700K 3000K 4000K	10740Lm (4000K)	9000Lm (4000K)	120°	1525,00
NVW90DS	BLANC MAT - DORÉ	ALUMINIUM	68W	2700K 3000K 4000K	10740Lm (4000K)	9000Lm (4000K)	120°	1525,00
ACCESSOIRES	MATIÈRE	DESCRIPTION						€
NV90UPM	POLYCARBONATE	KIT UPLIGHT 28W 3000K 2400Lm						274,00



DANS LA MÊME GAMME



NOVA CSP 3 P PAGE 235



NOIR MAT - DORÉ



BLANC MAT - DORÉ



- Luminaire apparent au design moderne et élégant.
- Excellent confort visuel grâce à un UGR inférieur à 19. Convient à l'éclairage de bureaux et salles de classe.
- Sélection de la température de couleur (2700K, 3000K ou 4000K).
- Rendement élevé (efficacité lumineuse supérieure à 115lm/W).
- Diffuseur à structure prismatique de haute qualité.
- Trois modes de variation : DALI, Push-dim ou 1-10V.
- Garantie de 5 ans.
- Kit d'éclairage indirect disponible séparément.

DOTS C

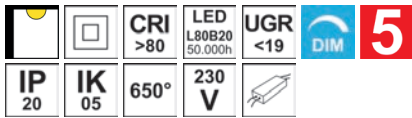

- Plafonnier rectangulaire fixe pour éclairage d'accentuation.
- Réflecteur basse luminance.
- Convertisseur dimmable intégré dans l'appareil.
- Compatible avec variateur début et fin de phase.

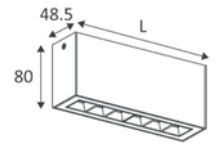

DOTS C	COULEUR	MATIÈRE	P	T°	L(MM)	LED LUMEN	SYSTEM LUMEN	α	€
WA248WW05	NOIR MAT	ALUMINIUM	6W	3000K	108	470Lm	300Lm	45°	78,00
WA248WW30	BLANC MAT	ALUMINIUM	6W	3000K	108	470Lm	300Lm	45°	78,00
WA249WW05	NOIR MAT	ALUMINIUM	12W	3000K	188	940Lm	565Lm	45°	111,00
WA249WW30	BLANC MAT	ALUMINIUM	12W	3000K	188	940Lm	565Lm	45°	111,00
WA250WW05	NOIR MAT	ALUMINIUM	16W	3000K	268	1400Lm	895Lm	45°	129,00
WA250WW30	BLANC MAT	ALUMINIUM	16W	3000K	268	1400Lm	895Lm	45°	129,00
WA251WW05	NOIR MAT	ALUMINIUM	20W	3000K	348	1880Lm	1165Lm	45°	150,00
WA251WW30	BLANC MAT	ALUMINIUM	20W	3000K	348	1880Lm	1165Lm	45°	150,00

DANS LA MÊME GAMME



DOTS PAGE 80

NOIR MAT

BLANC MAT

NOIR MAT

BLANC MAT



NOIR MAT

BLANC MAT

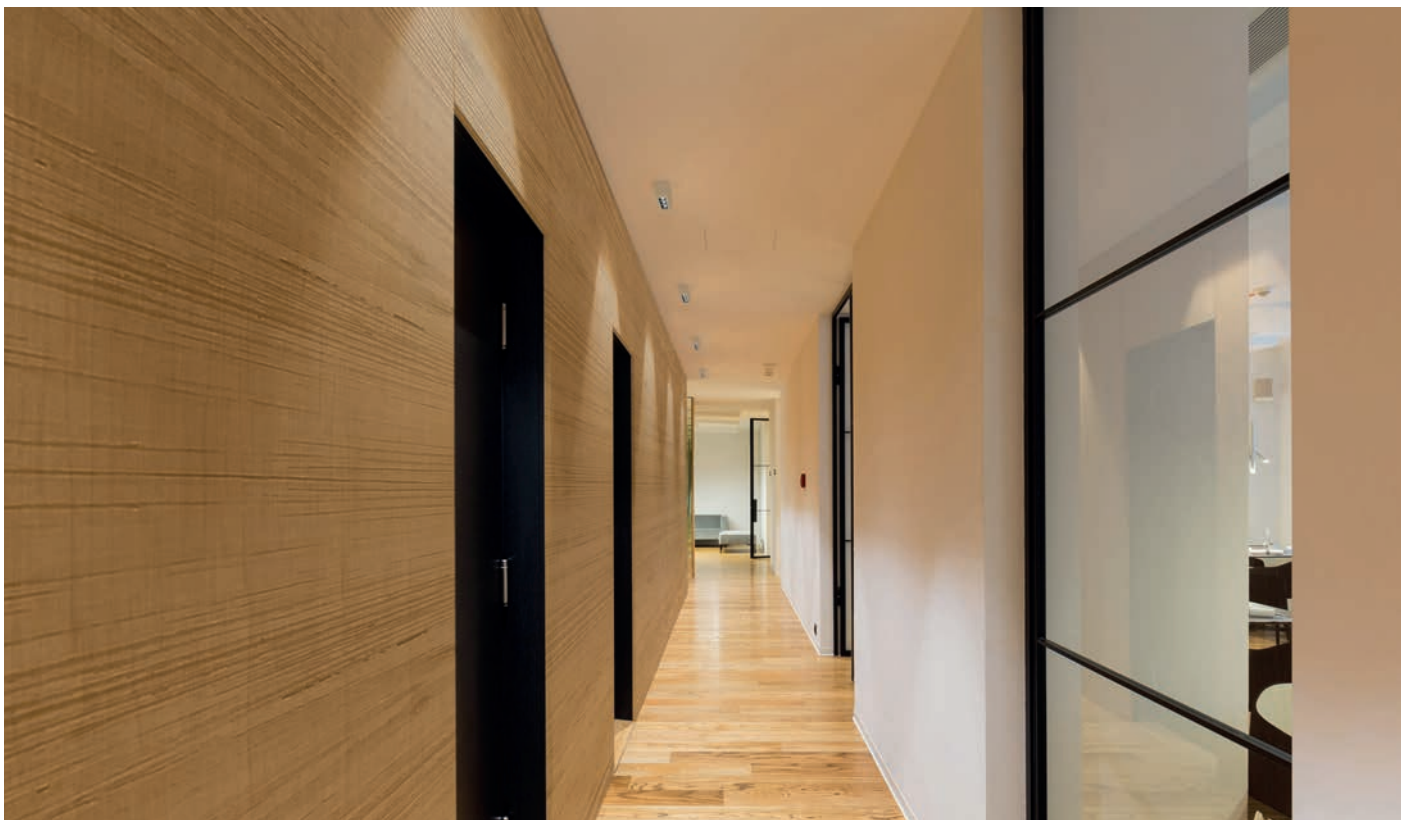



PLAFONNIERS

TOMY 1 C

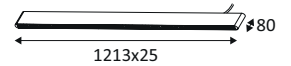
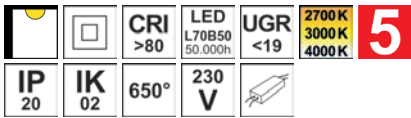

- Plafonnier linéaire.
- Réflecteur basse luminance.
- 2700K, 3000K ou 4000K au choix via un interrupteur à l'arrière du luminaire.
- Livré avec câble d'alimentation noir ou blanc.
- Convertisseur non dimmable intégré dans l'appareil.

TOMY 1 C	COULEUR	MATIÈRE	P	T°	L(MM)	LED LUMEN	SYSTEM LUMEN	α	€
WA22405	■ NOIR MAT	ALUMINIUM	36W	2700K 3000K 4000K	1213	4100Lm (4000K)	2835Lm (4000K)	36°	197,00
WA22430	■ BLANC MAT	ALUMINIUM	36W	2700K 3000K 4000K	1213	4100Lm (4000K)	2835Lm (4000K)	36°	197,00

DANS LA MÊME GAMME



NOIR MAT

BLANC MAT



TOMY 1 P PAGE 236



TOMY 2 P PAGE 236



INDIGO

LIGHTING



SUSPENSIONS



OKTO P GU10



- Suspension décorative.
- Livrée avec câble d'alimentation textile (réglable 1.50m max).
- Coloris 05 - 08 - 06 - 83 : câble noir.
- Coloris 30 - 49 - 02 - 82 : câble blanc.

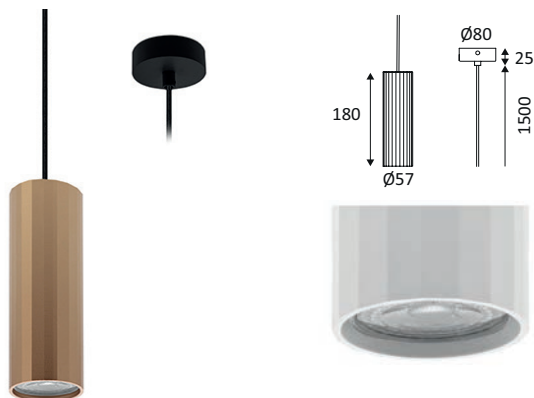

OKTO P GU10	COULEUR	MATIÈRE	SOQUET	LAMPE	WATT MAX	€
SU16005	NOIR MAT	ALUMINIUM	GU10	PAR16 LED	10W	75,00
SU16008	NOIR MAT - CHAMPAGNE	ALUMINIUM	GU10	PAR16 LED	10W	81,00
SU16006	NOIR MAT - OR ROSE	ALUMINIUM	GU10	PAR16 LED	10W	81,00
SU16083	NOIR MAT - ROSE	ALUMINIUM	GU10	PAR16 LED	10W	87,00
SU16030	BLANC MAT	ALUMINIUM	GU10	PAR16 LED	10W	75,00
SU16049	BLANC MAT - CHAMPAGNE	ALUMINIUM	GU10	PAR16 LED	10W	81,00
SU16002	BLANC MAT - OR ROSE	ALUMINIUM	GU10	PAR16 LED	10W	81,00
SU16082	BLANC MAT - ROSE	ALUMINIUM	GU10	PAR16 LED	10W	87,00

DANS LA MÊME GAMME



OKTO GU10 PAGE 182



OKTO 2 GU10 PAGE 149



OKTO RX GU10 PAGE 87





SUSPENSIONS

AUREA P

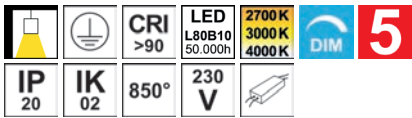

- Suspension décorative.
- Livrée avec câble d'alimentation (réglable 2.00m max).
- Coloris 05 - 08 - 83 : câble noir.
- Coloris 30 - 49 - 82 : câble blanc.
- 2700K, 3000K ou 4000K au choix via un interrupteur à l'arrière du luminaire.
- Convertisseur dimmable intégré dans l'appareil.
- Compatible avec variateur début de phase.

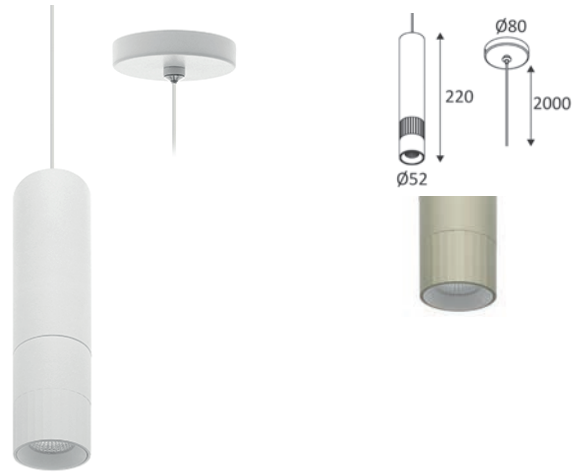

AUREA P	COULEUR	MATIÈRE	P	T°	LED LUMEN	SYSTEM LUMEN	α	€
SU16905	NOIR MAT	ALUMINIUM	6W	2700K 3000K 4000K	715Lm (4000K)	550Lm (4000K)	38°	146,00
SU16908	NOIR MAT - CHAMPAGNE	ALUMINIUM	6W	2700K 3000K 4000K	715Lm (4000K)	550Lm (4000K)	38°	149,00
SU16983	NOIR MAT - ROSE	ALUMINIUM	6W	2700K 3000K 4000K	715Lm (4000K)	550Lm (4000K)	38°	149,00
SU16930	BLANC MAT	ALUMINIUM	6W	2700K 3000K 4000K	715Lm (4000K)	550Lm (4000K)	38°	146,00
SU16949	BLANC MAT - CHAMPAGNE	ALUMINIUM	6W	2700K 3000K 4000K	715Lm (4000K)	550Lm (4000K)	38°	149,00
SU16982	BLANC MAT - ROSE	ALUMINIUM	6W	2700K 3000K 4000K	715Lm (4000K)	550Lm (4000K)	38°	149,00



JACK 3 P

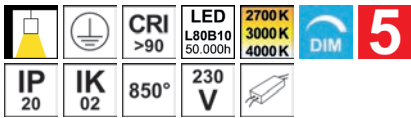

- Suspension décorative.
- Livrée avec câble d'alimentation textile (réglable 1.60m max).
- Coloris 05 - 13 - 06 : câble noir.
- Coloris 30 - 28 - 02 : câble blanc.
- 2700K, 3000K ou 4000K au choix via un interrupteur à l'arrière du luminaire.
- Convertisseur dimmable intégré dans l'appareil.
- Compatible avec variateur fin de phase.



JACK 3 P	COULEUR	MATIÈRE	P	T°	LED LUMEN	SYSTEM LUMEN	α	€
SU16105	NOIR MAT	ALUMINIUM	25W	2700K 3000K 4000K	2810Lm (4000K)	2270Lm (4000K)	60°	221,00
SU16113	NOIR MAT - LAITON	ALUMINIUM	25W	2700K 3000K 4000K	2810Lm (4000K)	2270Lm (4000K)	60°	245,00
SU16106	NOIR MAT - OR ROSE	ALUMINIUM	25W	2700K 3000K 4000K	2810Lm (4000K)	2270Lm (4000K)	60°	245,00
SU16130	BLANC MAT	ALUMINIUM	25W	2700K 3000K 4000K	2810Lm (4000K)	2270Lm (4000K)	60°	221,00
SU16128	BLANC MAT - LAITON	ALUMINIUM	25W	2700K 3000K 4000K	2810Lm (4000K)	2270Lm (4000K)	60°	245,00
SU16102	BLANC MAT - OR ROSE	ALUMINIUM	25W	2700K 3000K 4000K	2810Lm (4000K)	2270Lm (4000K)	60°	245,00





SUSPENSIONS

JACK 3 P



RETI P



- Suspension décorative.
- Faisceau lumineux précisément dessiné grâce à une lentille en verre de haute qualité.
- Livrée avec câble d'alimentation noir facilement réglable (de 1.00 à 2.30m) grâce à un système de poulie.
- Convertisseur non dimmable intégré dans l'appareil.



RETI P	COULEUR	MATIÈRE	P	T°	LED LUMEN	SYSTEM LUMEN	α	€
SU173WW05	NEW NOIR MAT	ALUMINIUM	12W	3000K	1080Lm	1035Lm	80°	299,00
SU173WW31	NEW NOIR MAT - BRONZE SATINÉ	ALUMINIUM	12W	3000K	1080Lm	1035Lm	80°	299,00
SU173WW30	NEW BLANC MAT	ALUMINIUM	12W	3000K	1080Lm	1035Lm	80°	299,00



DANS LA MÊME GAMME



RETI 2 RX PAGE 94



RETI 1 RX PAGE 94



RETI W PAGE 152

RETI P



- Déclinable en applique, suspension ou semi-encastré.
- Faisceau lumineux précisément dessiné donnant un effet graphique.
- Finition de qualité supérieure.

HELLO 1 P

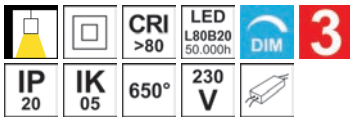

- Suspension décorative.
- Diffuseur en PMMA.
- Livrée avec câble d'alimentation textile noir ou blanc (réglable 2.00m max).
- Convertisseur dimmable intégré dans la base.
- Compatible avec variateur début et fin de phase.

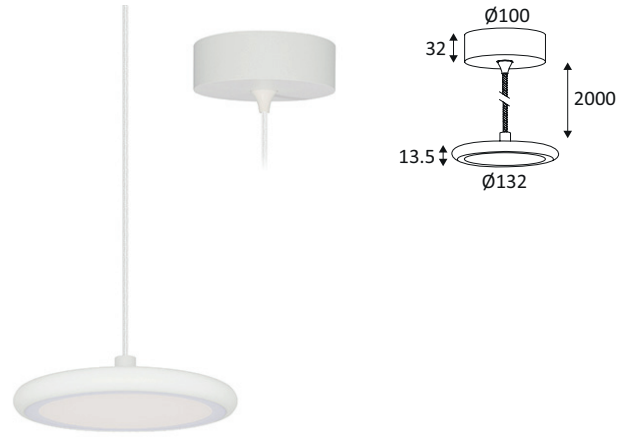

HELLO 1 P	COULEUR	MATIÈRE	P	T°	LED LUMEN	SYSTEM LUMEN	α	€
SU166WW05	NOIR MAT	ALUMINIUM	11W	3000K	1300Lm	1070Lm	110°	135,00
SU166WW30	BLANC MAT	ALUMINIUM	11W	3000K	1300Lm	1070Lm	110°	135,00



DANS LA MÊME GAMME



HELLO 1 D PAGE 286

HELLO 2 P

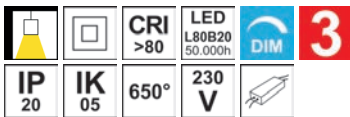

- Suspension décorative.
- Diffuseur en PMMA.
- Livrée avec câble d'alimentation textile noir ou blanc (réglable 2.00m max).
- Convertisseur dimmable intégré dans la base.
- Compatible avec variateur début et fin de phase.



HELLO 2 P	COULEUR	MATIÈRE	P	T°	LED LUMEN	SYSTEM LUMEN	α	€
SU167WW05	NOIR MAT	ALUMINIUM	18W	3000K	2160Lm	1835Lm	110°	179,00
SU167WW30	BLANC MAT	ALUMINIUM	18W	3000K	2160Lm	1835Lm	110°	179,00



DANS LA MÊME GAMME



HELLO 2 D PAGE 286



SUSPENSIONS

HELLO 2 P



HUBA P

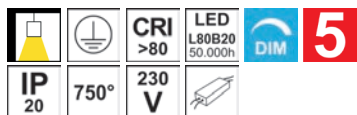

- Suspension décorative.
- Eclairage indirect via le réflecteur au design ondulé créant une ambiance agréable.
- Livrée avec câble d'alimentation textile noir ou blanc (réglable 1.40m max).
- Convertisseur dimmable intégré dans l'appareil.
- Compatible avec variateur début et fin de phase.



HUBA P	COULEUR	MATIÈRE	P	T°	LED LUMEN	SYSTEM LUMEN	α	€
AIN3KPLBKWH	NEW NOIR MAT - BLANC MAT	ACIER	15W	3000K	1600Lm	1140Lm	120°	119,00
AIN3KPLBKGD	NEW NOIR MAT - DORÉ	ACIER	15W	3000K	1600Lm	745Lm	120°	119,00
AIN3KPLWHWH	NEW BLANC MAT	ACIER	15W	3000K	1600Lm	1140Lm	120°	119,00
AIN3KPLWHGD	NEW BLANC MAT - DORÉ	ACIER	15W	3000K	1600Lm	745Lm	120°	119,00

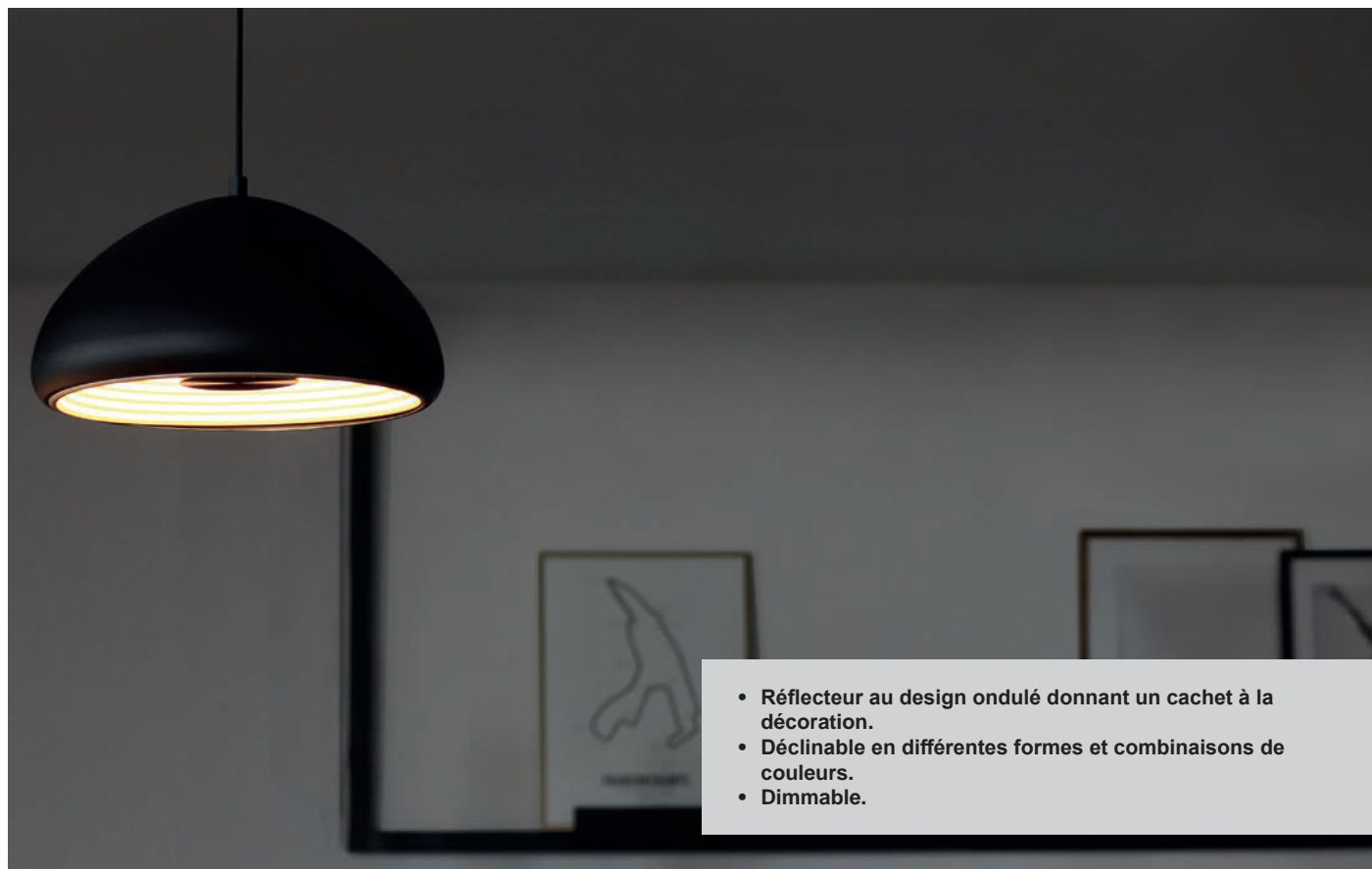

- Réflecteur au design ondulé donnant un cachet à la décoration.
- Déclinable en différentes formes et combinaisons de couleurs.
- Dimmable.



SUSPENSIONS

HULA P

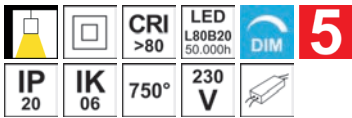

- Suspension décorative.
- Eclairage direct diffus via l'anneau externe et indirect via le réflecteur au design ondulé créant une ambiance agréable.
- Livrée avec câbles de suspension blancs ou noirs (réglables 1.50m max), base ronde et câble d'alimentation textile blancs ou noirs.
- Convertisseur dimmable intégré dans l'appareil.
- Compatible avec variateur début et fin de phase.



NEW

HULA P	COULEUR	MATIÈRE	P	T°	LED LUMEN	SYSTEM LUMEN	α	€
SU174WW35	NEW NOIR MAT - BLANC MAT	PLASTIQUE	18W	3000K	1850Lm	1000Lm	120°	156,00
SU174WW36	NEW NOIR MAT - DORÉ	PLASTIQUE	18W	3000K	1850Lm	1000Lm	120°	162,00
SU174WW30	NEW BLANC MAT	PLASTIQUE	18W	3000K	1850Lm	1000Lm	120°	156,00
SU174WW80	NEW BLANC MAT - DORÉ	PLASTIQUE	18W	3000K	1850Lm	1000Lm	120°	162,00



NOIR MAT - BLANC MAT NOIR MAT - DORÉ BLANC MAT BLANC MAT - DORÉ MAT

DANS LA MÊME GAMME



HULA C PAGE 204



- Réflecteur au design ondulé donnant un cachet à la décoration.
- Déclinable en différentes formes et combinaisons de couleurs.
- Dimmable.

JUNE 1 P

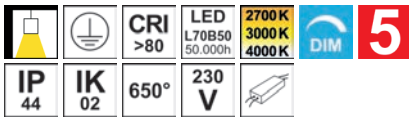

- Suspension décorative.
- Diffuseur en PS opalin.
- 2700K, 3000K ou 4000K au choix via un interrupteur dans le luminaire.
- Livrée avec câbles de suspension blancs ou noirs (réglables 1.50m max), base ronde et câble d'alimentation blancs ou noirs.
- Convertisseur dimmable intégré dans l'appareil.
- Compatible avec variateur début et fin de phase.

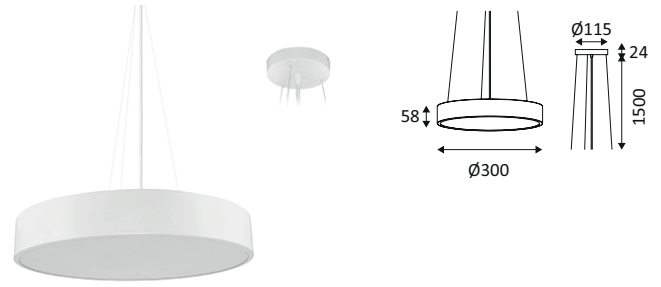

JUNE 1 P	COULEUR	MATIÈRE	P	T°	LED LUMEN	SYSTEM LUMEN	α	€
SU15605	■ NOIR MAT	ALUMINIUM	18W	2700K 3000K 4000K	3300Lm (4000K)	1775Lm (4000K)	120°	131,00
SU15630	■ BLANC MAT	ALUMINIUM	18W	2700K 3000K 4000K	3300Lm (4000K)	1775Lm (4000K)	120°	131,00



NOIR MAT BLANC MAT

DANS LA MÊME GAMME

JUNE 1 C PAGE 206

JUNE 2 P

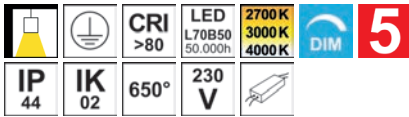

- Suspension décorative.
- Diffuseur en PS opalin.
- 2700K, 3000K ou 4000K au choix via un interrupteur dans le luminaire.
- Livrée avec câbles de suspension blancs ou noirs (réglables 1.50m max), base ronde et câble d'alimentation blancs ou noirs.
- Convertisseur dimmable intégré dans l'appareil.
- Compatible avec variateur début et fin de phase.

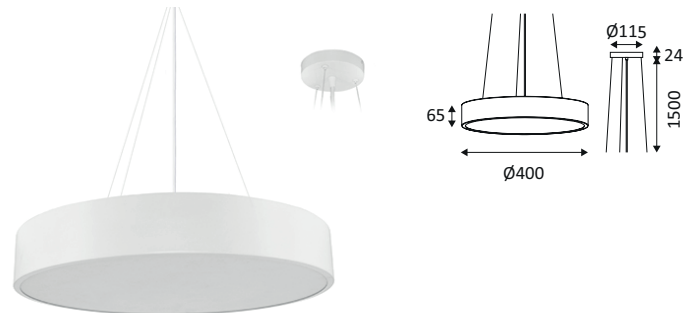

JUNE 2 P	COULEUR	MATIÈRE	P	T°	LED LUMEN	SYSTEM LUMEN	α	€
SU15705	■ NOIR MAT	ALUMINIUM	30W	2700K 3000K 4000K	5600Lm (4000K)	3325Lm (4000K)	120°	191,00
SU15730	■ BLANC MAT	ALUMINIUM	30W	2700K 3000K 4000K	5600Lm (4000K)	3325Lm (4000K)	120°	191,00



NOIR MAT BLANC MAT

DANS LA MÊME GAMME

JUNE 2 C PAGE 206



SUSPENSIONS

JUNE 3 P

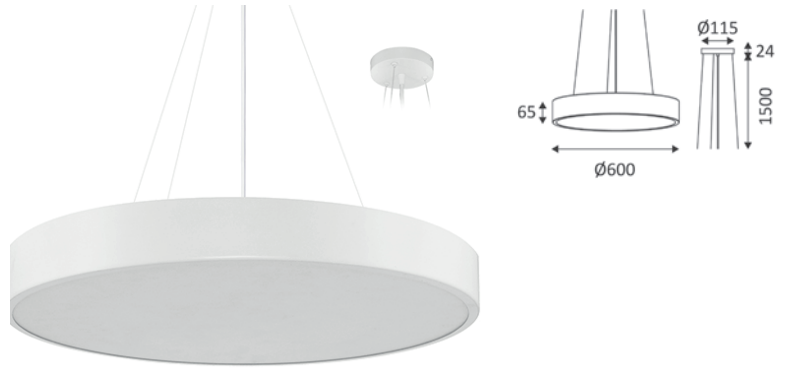
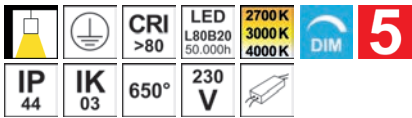

- Suspension décorative.
- Diffuseur en PS opalin.
- 2700K, 3000K ou 4000K au choix via un interrupteur dans le luminaire.
- Livrée avec câbles de suspension blancs ou noirs (réglables 1.50m max), base ronde et câble d'alimentation blancs ou noirs.
- Convertisseur dimmable intégré dans l'appareil.
- Compatible avec variateur début et fin de phase.

JUNE 3 P	COULEUR	MATIÈRE	P	T°	LED LUMEN	SYSTEM LUMEN	α	€
SU16305	■ NOIR MAT	ALUMINIUM	50W	2700K 3000K 4000K	8000Lm (4000K)	5920Lm (4000K)	120°	321,00
SU16330	■ BLANC MAT	ALUMINIUM	50W	2700K 3000K 4000K	8000Lm (4000K)	5920Lm (4000K)	120°	321,00

DANS LA MÊME GAMME



NOIR MAT

BLANC MAT



JUNE 3 C PAGE 207

JUNE 1 P



CAPRI R 1 P

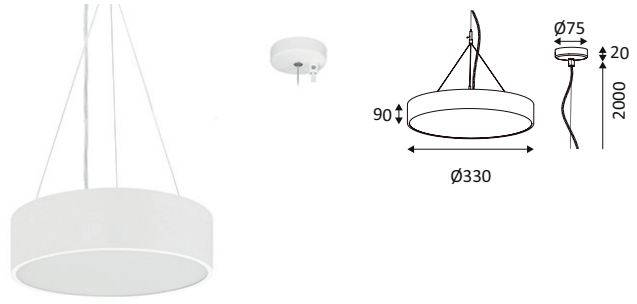

- Suspension ronde.
- Diffuseur PS à structure prismatique.
- 2700K, 3000K ou 4000K au choix via un interrupteur dans le luminaire.
- Livrée avec câbles de suspension en acier (réglables 2.00m max), base ronde et câble d'alimentation blancs ou noirs.
- Convertisseur dimmable coupure de phase ou dimmable DALI-push intégré dans l'appareil.

CAPRI R 1 P	COULEUR	MATIÈRE	P	T°	LED LUMEN	SYSTEM LUMEN	α	€
DIMMABLE COUPURE DE PHASE								
SU15305	NOIR MAT	ALUMINIUM	20W	2700K 3000K 4000K	2400Lm (4000K)	1360Lm (4000K)	90°	290,00
SU15330	BLANC MAT	ALUMINIUM	20W	2700K 3000K 4000K	2400Lm (4000K)	1360Lm (4000K)	90°	290,00
DIMMABLE DALI								
SU15305DA	NOIR MAT	ALUMINIUM	20W	2700K 3000K 4000K	2400Lm (4000K)	1360Lm (4000K)	90°	456,00
SU15330DA	BLANC MAT	ALUMINIUM	20W	2700K 3000K 4000K	2400Lm (4000K)	1360Lm (4000K)	90°	456,00



DANS LA MÊME GAMME

CAPRI R 1 C PAGE 208

CAPRI R 2 P

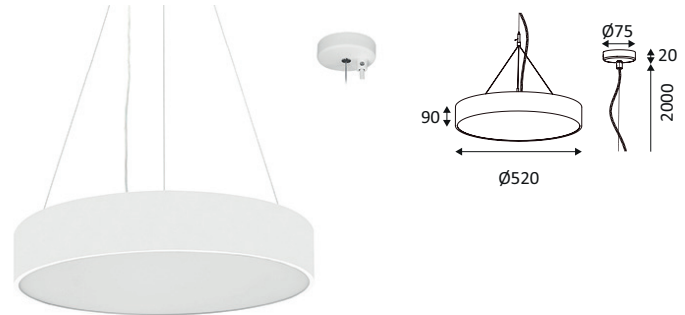

- Suspension ronde.
- Diffuseur PS à structure prismatique.
- 2700K, 3000K ou 4000K au choix via un interrupteur dans le luminaire.
- Livrée avec câbles de suspension en acier (réglables 2.00m max), base ronde et câble d'alimentation blancs ou noirs.
- Convertisseur dimmable coupure de phase ou dimmable DALI-push intégré dans l'appareil.

CAPRI R 2 P	COULEUR	MATIÈRE	P	T°	LED LUMEN	SYSTEM LUMEN	α	€
DIMMABLE COUPURE DE PHASE								
SU15405	NOIR MAT	ALUMINIUM	42W	2700K 3000K 4000K	5150Lm (4000K)	2910Lm (4000K)	90°	424,00
SU15430	BLANC MAT	ALUMINIUM	42W	2700K 3000K 4000K	5150Lm (4000K)	2910Lm (4000K)	90°	424,00
DIMMABLE DALI								
SU15405DA	NOIR MAT	ALUMINIUM	42W	2700K 3000K 4000K	5150Lm (4000K)	2910Lm (4000K)	90°	613,00
SU15430DA	BLANC MAT	ALUMINIUM	42W	2700K 3000K 4000K	5150Lm (4000K)	2910Lm (4000K)	90°	613,00



DANS LA MÊME GAMME

CAPRI R 2 C PAGE 209



SUSPENSIONS

CAPRI R 3 P



- Suspension ronde.
- Diffuseur PS à structure prismatique.
- 2700K, 3000K ou 4000K au choix via un interrupteur dans le luminaire.
- Livrée avec câbles de suspension en acier (réglables 2.00m max), base ronde et câble d'alimentation blancs ou noirs.
- Convertisseur dimmable DALI intégré dans l'appareil.

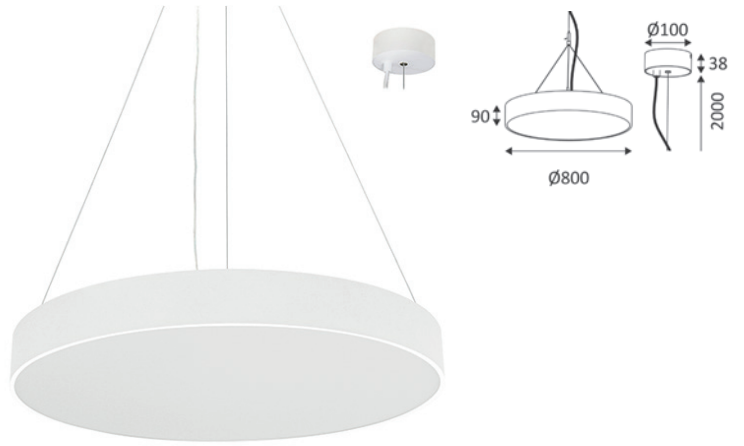

CAPRI R 3 P	COULEUR	MATIÈRE	P	T°	LED LUMEN	SYSTEM LUMEN	α	€
DIMMABLE DALI								
SU15505DA	■ NOIR MAT	ALUMINIUM	105W	2700K 3000K 4000K	11800Lm (4000K)	7070Lm (4000K)	90°	1203,00
SU15530DA	■ BLANC MAT	ALUMINIUM	105W	2700K 3000K 4000K	11800Lm (4000K)	7070Lm (4000K)	90°	1203,00



DANS LA MÊME GAMME

 CAPRI R 3 C PAGE 210

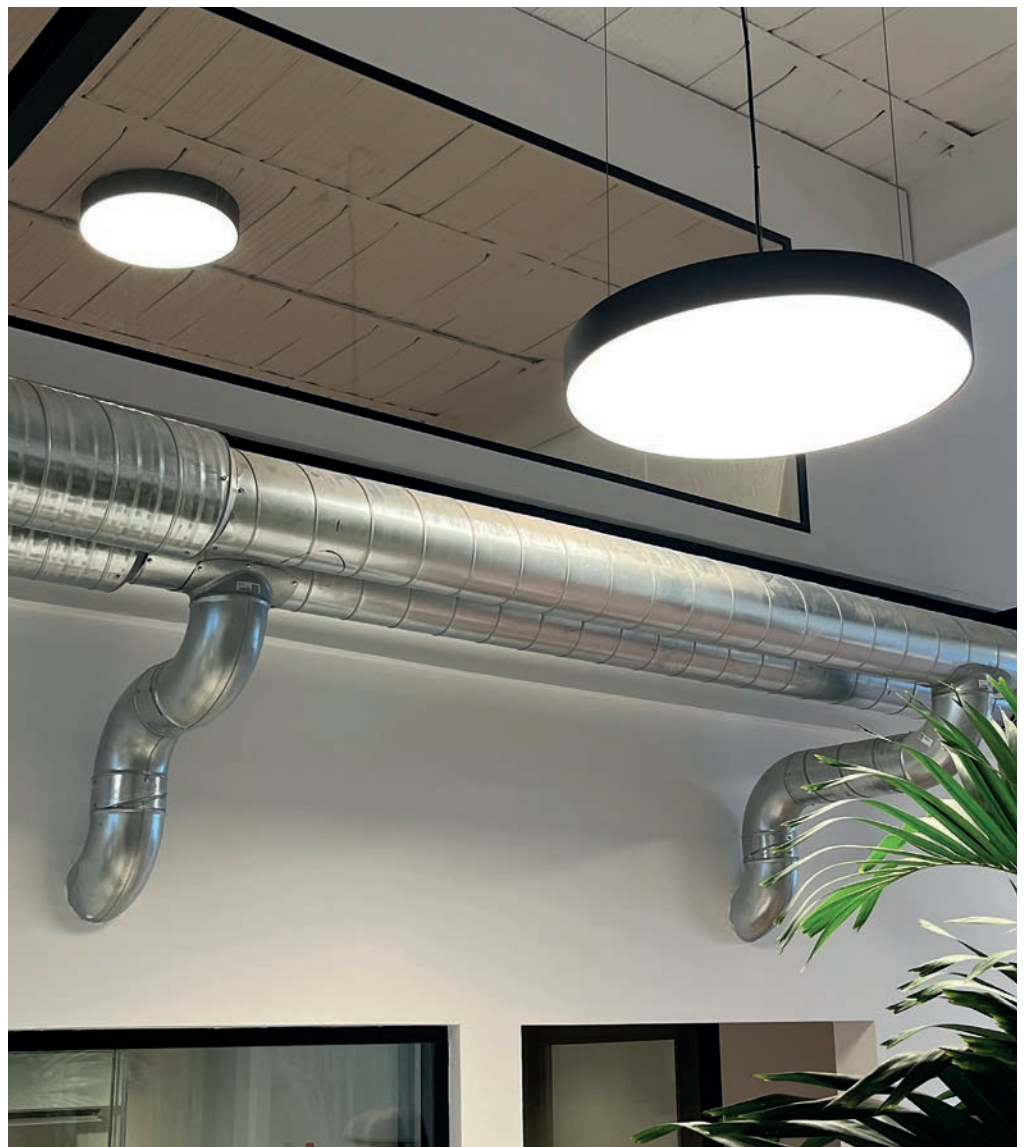

SUSPENSIONS

CAPRI S 1 P



- Suspension carrée.
- Diffuseur PS à structure prismatique.
- 2700K, 3000K ou 4000K au choix via un interrupteur dans le luminaire.
- Livrée avec câbles de suspension en acier (réglables 2.00m max), base ronde et câble d'alimentation blancs ou noirs.
- Convertisseur dimmable coupure de phase ou dimmable DALI-push intégré dans l'appareil.

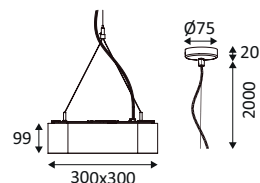

CAPRI S 1 P	COULEUR	MATIÈRE	P	T°	L(MM)	LED LUMEN	SYSTEM LUMEN	α	€
DIMMABLE COUPURE DE PHASE									
SU16405	■ NOIR MAT	ALUMINIUM	20W	2700K 3000K 4000K	300	2400Lm (4000K)	1335Lm (4000K)	90°	330,00
SU16430	■ BLANC MAT	ALUMINIUM	20W	2700K 3000K 4000K	300	2400Lm (4000K)	1335Lm (4000K)	90°	330,00
DIMMABLE DALI									
SU16405DA	■ NOIR MAT	ALUMINIUM	20W	2700K 3000K 4000K	300	2400Lm (4000K)	1335Lm (4000K)	90°	512,00
SU16430DA	■ BLANC MAT	ALUMINIUM	20W	2700K 3000K 4000K	300	2400Lm (4000K)	1335Lm (4000K)	90°	512,00



DANS LA MÊME GAMME

CAPRI S 1 C PAGE 211

CAPRI S 2 P



- Suspension carrée.
- Diffuseur PS à structure prismatique.
- 2700K, 3000K ou 4000K au choix via un interrupteur dans le luminaire.
- Livrée avec câbles de suspension en acier (réglables 2.00m max), base ronde et câble d'alimentation blancs ou noirs.
- Convertisseur dimmable coupure de phase ou dimmable DALI-push intégré dans l'appareil.

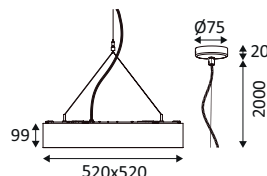

CAPRI S 2 P	COULEUR	MATIÈRE	P	T°	L(MM)	LED LUMEN	SYSTEM LUMEN	α	€
DIMMABLE COUPURE DE PHASE									
SU16505	■ NOIR MAT	ALUMINIUM	42W	2700K 3000K 4000K	520	5150Lm (4000K)	3175Lm (4000K)	90°	475,00
SU16530	■ BLANC MAT	ALUMINIUM	42W	2700K 3000K 4000K	520	5150Lm (4000K)	3175Lm (4000K)	90°	475,00
DIMMABLE DALI									
SU16505DA	■ NOIR MAT	ALUMINIUM	42W	2700K 3000K 4000K	520	5150Lm (4000K)	3175Lm (4000K)	90°	684,00
SU16530DA	■ BLANC MAT	ALUMINIUM	42W	2700K 3000K 4000K	520	5150Lm (4000K)	3175Lm (4000K)	90°	684,00

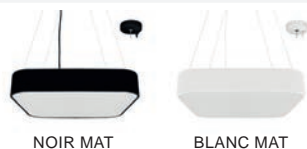

DANS LA MÊME GAMME

CAPRI S 2 C PAGE 211



SUSPENSIONS

CAPRI S 2 P



INDIGO

233

SUSPENSIONS

NOVA CSP 1 P



- Suspension ronde.
- Diffuseur microprismatique.
- 2700K, 3000K ou 4000K au choix via un interrupteur dans le luminaire.
- Livrée avec câbles de suspension en acier (réglables 2.00m max), base ronde et câble d'alimentation blancs ou noirs.
- Convertisseur dimmable DALI, Push-Dim et 1-10V intégré dans l'appareil.
- Kit d'éclairage indirect non-dimmable en option.



NOVA CSP 1 P	COULEUR	MATIÈRE	P	T°	LED LUMEN	SYSTEM LUMEN	α	€
SU17036	NOIR MAT - DORÉ	ALUMINIUM	26W	2700K 3000K 4000K	3930Lm (4000K)	3000Lm (4000K)	120°	610,00
SU17080	BLANC MAT - DORÉ	ALUMINIUM	26W	2700K 3000K 4000K	3930Lm (4000K)	3000Lm (4000K)	120°	673,00

ACCESSOIRES	MATIÈRE	DESCRIPTION	€
NV45UPM	POLYCARBONATE	KIT UPLIGHT 13W 3000K 1100Lm	124,00



NOIR MAT - DORÉ BLANC MAT - DORÉ

DANS LA MÊME GAMME



NOVA CSP 1 C PAGE 212

NOVA CSP 2 P



- Suspension ronde.
- Diffuseur microprismatique.
- 2700K, 3000K ou 4000K au choix via un interrupteur dans le luminaire.
- Livrée avec câbles de suspension en acier (réglables 2.00m max), base ronde et câble d'alimentation blancs ou noirs.
- Convertisseur dimmable DALI, Push-Dim et 1-10V intégré dans l'appareil.
- Kit d'éclairage indirect non-dimmable en option.



NOVA CSP 2 P	COULEUR	MATIÈRE	P	T°	LED LUMEN	SYSTEM LUMEN	α	€
SU17136	NOIR MAT - DORÉ	ALUMINIUM	40W	2700K 3000K 4000K	6075Lm (4000K)	4800Lm (4000K)	120°	811,00
SU17180	BLANC MAT - DORÉ	ALUMINIUM	40W	2700K 3000K 4000K	6075Lm (4000K)	4800Lm (4000K)	120°	874,00

ACCESSOIRES	MATIÈRE	DESCRIPTION	€
NV60UPM	POLYCARBONATE	KIT UPLIGHT 20W 3000K 1700Lm	181,00

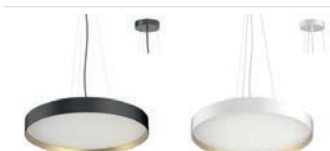

NOIR MAT - DORÉ BLANC MAT - DORÉ

DANS LA MÊME GAMME



NOVA CSP 2 C PAGE 212



SUSPENSIONS

NOVA CSP 3 P

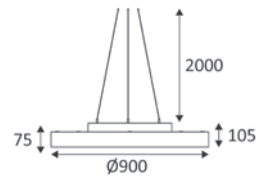

- Suspension ronde.
- Diffuseur microprismatique.
- 2700K, 3000K ou 4000K au choix via un interrupteur dans le luminaire.
- Livrée avec câbles de suspension en acier (réglables 2.00m max), base ronde et câble d'alimentation blancs ou noirs.
- Convertisseur dimmable DALI, Push-Dim et 1-10V intégré dans l'appareil.
- Kit d'éclairage indirect non-dimmable en option.

NOVA CSP 3 P	COULEUR	MATIÈRE	P	T°	LED LUMEN	SYSTEM LUMEN	α	€
SU17236	NOIR MAT - DORÉ	ALUMINIUM	68W	2700K 3000K 4000K	10740Lm (4000K)	9000Lm (4000K)	120°	1574,00
SU17280	BLANC MAT - DORÉ	ALUMINIUM	68W	2700K 3000K 4000K	10740Lm (4000K)	9000Lm (4000K)	120°	1637,00

ACCESSOIRES	MATIÈRE	DESCRIPTION	€
NV90UPM	POLYCARBONATE	KIT UPLIGHT 28W 3000K 2400Lm	274,00

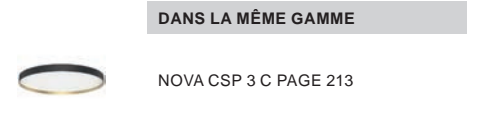

TOMY 1 P

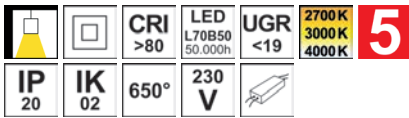

- Suspension linéaire.
- Réflecteur basse luminance.
- 2700K, 3000K ou 4000K au choix via un interrupteur à l'arrière du luminaire.
- Livrée avec câbles de suspension blancs ou noirs (réglables 2.00m max), base ronde et câble d'alimentation blancs ou noirs.
- Convertisseur non dimmable intégré dans l'appareil.

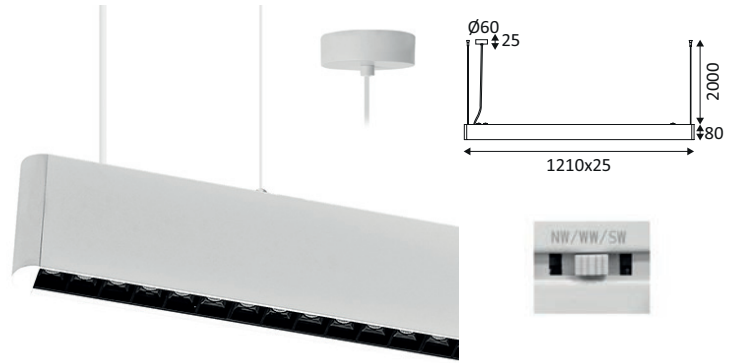

TOMY 1 P	COULEUR	MATIÈRE	P	T°	L(MM)	LED LUMEN	SYSTEM LUMEN	α	€
SU15805	■ NOIR MAT	ALUMINIUM	36W	2700K 3000K 4000K	1210	4100Lm (4000K)	2835Lm (4000K)	36°	200,00
SU15830	■ BLANC MAT	ALUMINIUM	36W	2700K 3000K 4000K	1210	4100Lm (4000K)	2835Lm (4000K)	36°	200,00



NOIR MAT

BLANC MAT

DANS LA MÊME GAMME



TOMY 1 C PAGE 215

TOMY 2 P

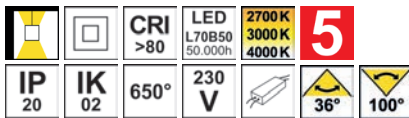

- Suspension linéaire.
- Eclairage «up», «down» ou «up&down» au choix via un interrupteur à l'arrière du luminaire.
- Réflecteur basse luminance (éclairage vers le bas) et diffuseur en polycarbonate (éclairage vers le haut).
- 2700K, 3000K ou 4000K au choix via un interrupteur à l'arrière du luminaire.
- Livrée avec câbles de suspension blancs ou noirs (réglables 2.00m max), base ronde et câble d'alimentation blancs ou noirs.
- Convertisseur non dimmable intégré dans l'appareil.

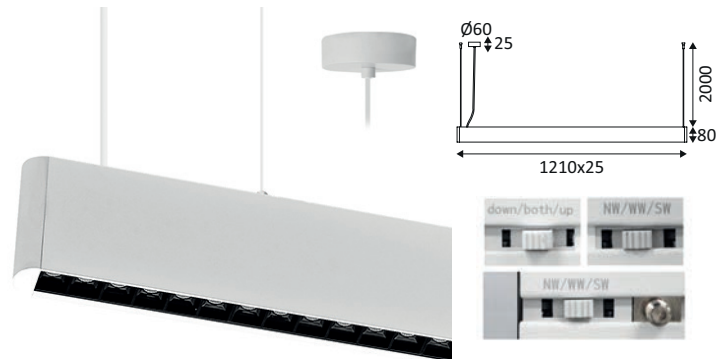

TOMY 2 P	COULEUR	MATIÈRE	P	T°	L(MM)	LED LUMEN	SYSTEM LUMEN	α	€
SU15905	■ NOIR MAT	ALUMINIUM	72W	2700K 3000K 4000K	1210	4100+3800Lm (4000K)	2835+2430Lm (4000K)	36° 100°	280,00
SU15930	■ BLANC MAT	ALUMINIUM	72W	2700K 3000K 4000K	1210	4100+3800Lm (4000K)	2835+2430Lm (4000K)	36° 100°	280,00



NOIR MAT

BLANC MAT

DANS LA MÊME GAMME



TOMY 1 C PAGE 215



SUSPENSIONS

OTIS 2 P

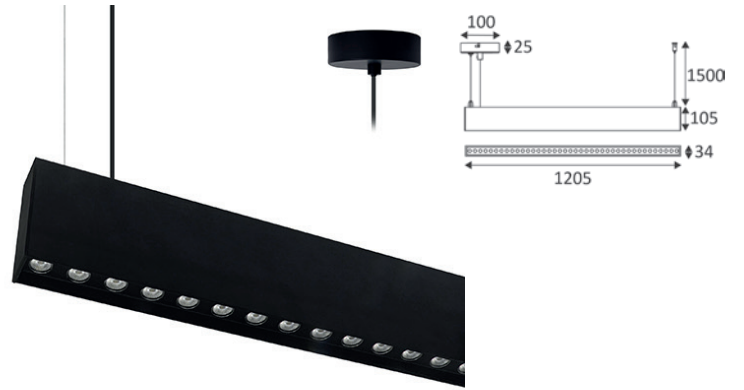
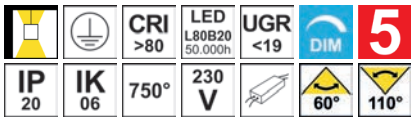

- Suspension linéaire.
- Eclairage «up», «down» ou «up&down» au choix via un interrupteur à l'arrière du luminaire.
- Réflecteur basse luminance (éclairage vers le bas) et diffuseur en polycarbonate (éclairage vers le haut).
- Livraison avec câbles de suspension blancs ou noirs (réglables 1.50m max), base ronde et câble d'alimentation blancs ou noirs.
- Convertisseur dimmable intégré dans l'appareil.
- Compatible avec variateur début et fin de phase.

OTIS 2 P	COULEUR	MATIÈRE	P	T°	L(MM)	LED LUMEN	SYSTEM LUMEN	α	€
SU168WW05	■ NOIR MAT	ALUMINIUM	35W	3000K	1205	3850Lm + 850Lm	3525Lm + 645Lm	60° 110°	350,00
SU168WW30	■ BLANC MAT	ALUMINIUM	35W	3000K	1205	3850Lm + 850Lm	3525Lm + 645Lm	60° 110°	350,00
SU168NW05	■ NOIR MAT	ALUMINIUM	35W	4000K	1205	4350Lm + 900Lm	3870Lm + 590Lm	60° 110°	350,00
SU168NW30	■ BLANC MAT	ALUMINIUM	35W	4000K	1205	4350Lm + 900Lm	3870Lm + 590Lm	60° 110°	350,00



NOIR MAT

BLANC MAT



INDIGO

LIGHTING



BANDEAUX & PROFILS



Tableau de compatibilité : PROFILS & BANDEAUX LEDS

	ST104	ST150	ST153	ST156	ST112	ST159	ST123	ST125	ST160	ST132
	5,4W/m	4,8W/m	9,6W/m	14,4W/m	14,4W/m	14,4W/m	14,4W/m	19,2W/m	22W/m	9,6W/m
PR115	V									
PR117	V	V	V					V	V	V
PR139	V	V	V							V
PR121			V	V	V	V	V			V
PR127	V									
PR130	V	V	V					V	V	V
PR146						V	V			
PR133		V	V							V
PR135		V	V							V
PR137				V	V	V	V	V	V	





Tableau de compatibilité : **CONVERTISSEURS** & BANDEAUX LEDS

BANDEAUX			CONVERTISSEURS														
			CD173	CD174	CD158	CD175	CD176	CD150	CD159	CD177	CD151	CD178	CD179	CD180	CD181	CD153	CD154
CODE	P	L max (m) ligne continue	30W	60W	60W	75W	120W	120W	150W	180W	200W	75W IP67	100W IP67	150W IP67	250W IP67	75W DIM	200W DIM
			LONGUEUR MAXIMALE DE BANDEAUX PAR ALIMENTATION (m)														
ST104	5,4W/m	10	5	10	10	12,5	20	20	25	30	33,3	12,5	16,6	25	41,6	12,5	33,3
ST150	4,8W/m	10	5,6	11,2	11,2	14	22,5	22,5	28,1	33,7	37,5	14	18,7	28,1	46,8	14	37,5
ST153	9,6W/m	10	2,8	5,6	5,6	7	11,2	11,2	14	16,8	18,7	7	9,3	14	23,4	7	18,7
ST156	14,4W/m	10	1,8	3,7	3,7	4,6	7,5	7,5	9,3	11,2	12,5	4,6	6,2	9,3	15,6	4,6	12,5
ST112	14,4W/m	10	1,8	3,7	3,7	4,6	7,5	7,5	9,3	11,2	12,5	4,6	6,2	9,3	15,6	4,6	12,5
ST159	14,4W/m	10	1,8	3,7	3,7	4,6	7,5	7,5	9,3	11,2	12,5	4,6	6,2	9,3	15,6	4,6	12,5
ST123	14,4W/m	10	1,8	3,7	3,7	4,6	7,5	7,5	9,3	11,2	12,5	4,6	6,2	9,3	15,6	4,6	12,5
ST125	19,2W/m	7	1,4	2,8	2,8	3,5	5,6	5,6	7	8,4	9,3	3,5	4,6	7	11,7	3,5	9,3
ST160	22W/m	6	1,2	2,4	2,4	3	4,9	4,9	6,1	7,3	8,1	3	4	6,1	10,2	3	8,1
ST132	9,6W/m	10	2,8	5,6	5,6	7	11,2	11,2	14	16,8	18,7	7	9,3	14	23,4	7	18,7
ST135	9,6W/m	10	2,8	5,6	5,6	7	11,2	11,2	14	16,8	18,7	7	9,3	14	23,4	7	18,7
ST135RGB	12W/m	10	2,2	4,5	4,5	5,6	9	9	11,2	13,5	15	5,6	7,5	11,2	18,8	5,6	15

Tableau de compatibilité : **CONTRÔLEURS** & BANDEAUX LEDS

BANDEAUX		CONTRÔLEURS				
		CD136	CD135	CD141	CD142	CD156
CODE	P (W/m)	Variateur	Contrôleur RGB	Contrôleur RGB+W	Contrôleur 2700-6000K	Contrôleur Bluetooth
ST104	5,4W/m	V				V
ST150	4,8W/m	V				V
ST153	9,6W/m	V				V
ST156	14,4W/m	V				V
ST112	14,4W/m		V	V		V
ST159	14,4W/m	V				V
ST123	14,4W/m		V	V		V
ST125	19,2W/m			V		V
ST160	22W/m	V				V
ST132	9,6W/m				V	V
ST135	9,6W/m	V				V
ST135RGB	12W/m		V	V		V

ST104

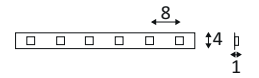

- Bandeau LED (SMD 2216).
- Rouleau 5m.
- Précâblé en début et fin de bandeau.
- Autocollant.
- Sécable toutes les 6 LEDs, 50mm.
- Convertisseur à commander séparément.



ST104	PUISSANCE PAR MÈTRE	T°	FLUX LUMINEUX PAR MÈTRE	L(MM)	€
ST104WW	5,4W	3000K	460Lm	5000	64,00
ST104NW	5,4W	4000K	475Lm	5000	64,00
ST104CW	5,4W	6000K	475Lm	5000	64,00

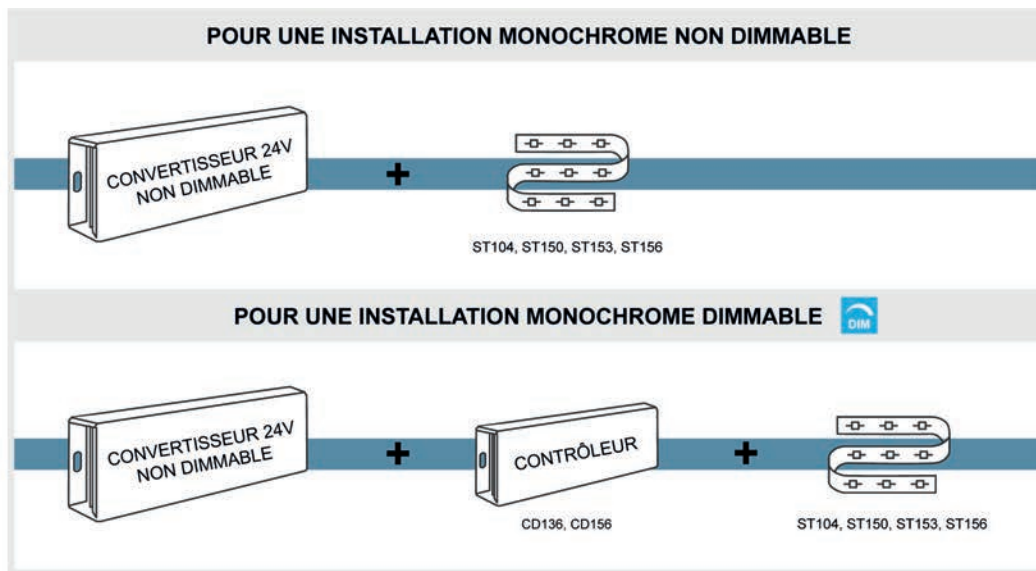



BANDEAUX



ST150



- Bandeau LED (SMD 2835).
- Rouleau 5m.
- Précâblé en début et fin de bandeau.
- Autocollant.
- Sécable toutes les 6 LEDs, 100mm.
- Convertisseur et accessoires à commander séparément.



ST150	PUISSANCE PAR MÈTRE	T°	FLUX LUMINEUX PAR MÈTRE	L(MM)	€
ST150SW	4,8W	2700K	380Lm	5000	48,00
ST150WW	4,8W	3000K	400Lm	5000	48,00
ST150NW	4,8W	4000K	410Lm	5000	48,00
ST150CW	4,8W	6000K	400Lm	5000	48,00

ACCESSOIRES	DESCRIPTION	L(MM)		€
ST151	CONNECTEUR	24		9,00
ST152	INTERCONNECTEUR	19,5		9,00







ST153



- Bandeau LED (SMD 2835).
- Rouleau 5m.
- Précâblé en début et fin de bandeau.
- Autocollant.
- Sécable toutes les 6 LEDs, 50mm.
- Convertisseur et accessoires à commander séparément.



ST153	PUISSANCE PAR MÈTRE	T°	FLUX LUMINEUX PAR MÈTRE	L(MM)	€
ST153SW	9,6W	2700K	750Lm	5000	68,00
ST153WW	9,6W	3000K	790Lm	5000	68,00
ST153NW	9,6W	4000K	800Lm	5000	68,00
ST153CW	9,6W	6000K	790Lm	5000	68,00

ACCESSOIRES	DESCRIPTION	L(MM)		€
ST151	CONNECTEUR	24	 	9,00
ST152	INTERCONNECTEUR	19,5	 	9,00

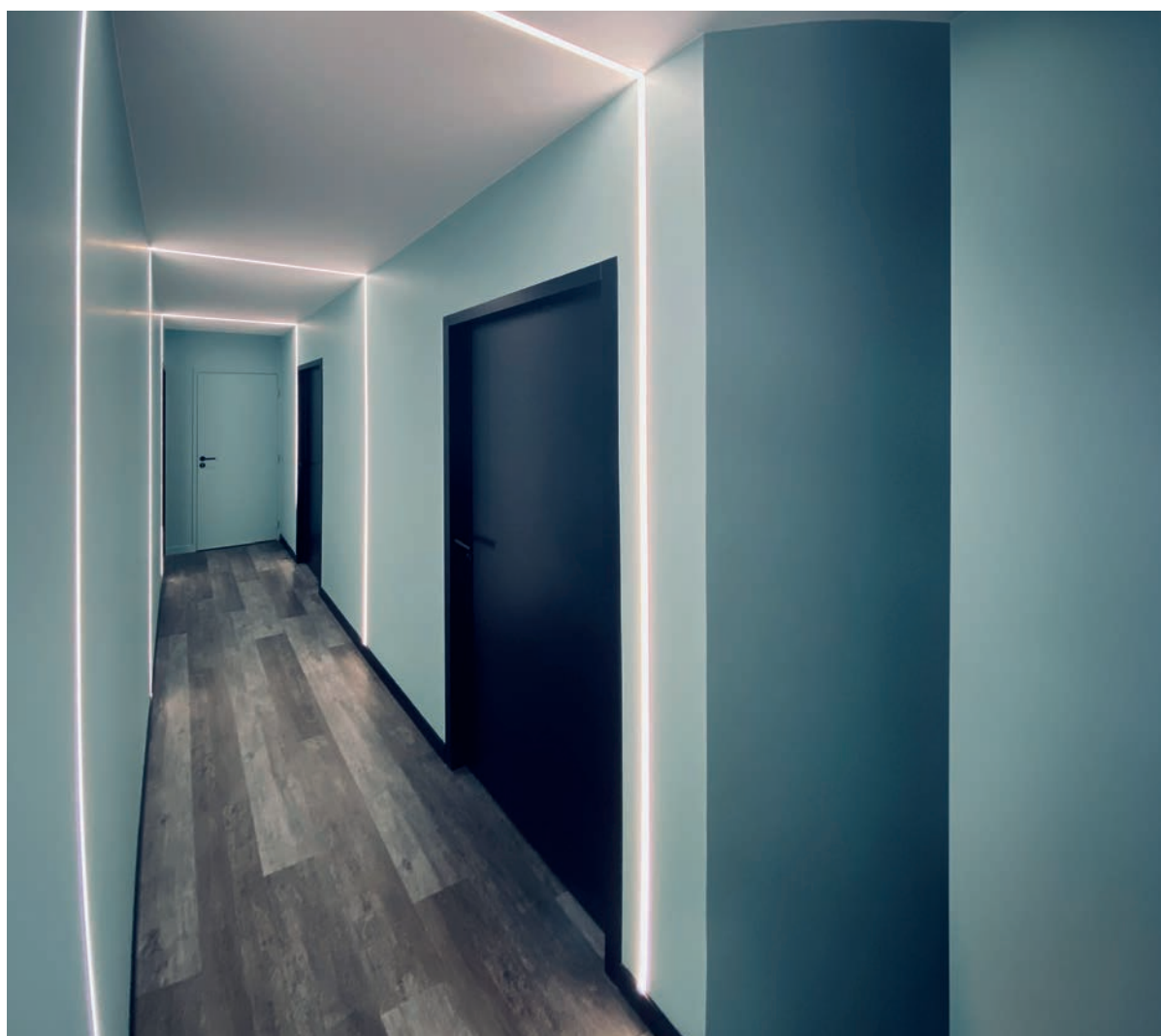



ST156



- Bandeau LED (SMD 2835).
- Rouleau 5m.
- Précâblé en début et fin de bandeau.
- Autocollant.
- Sécable toutes les 6 LEDs, 50mm.
- Convertisseur et accessoires à commander séparément.



ST156	PUISSANCE PAR MÈTRE	T°	FLUX LUMINEUX PAR MÈTRE	L(MM)	€
ST156SW	14,4W	2700K	1200Lm	5000	87,00
ST156WW	14,4W	3000K	1270Lm	5000	87,00
ST156NW	14,4W	4000K	1320Lm	5000	87,00
ST156CW	14,4W	6000K	1270Lm	5000	87,00

ACCESSOIRES	DESCRIPTION	L(MM)			€
ST151	CONNECTEUR	24			9,00
ST152	INTERCONNECTEUR	19,5			9,00

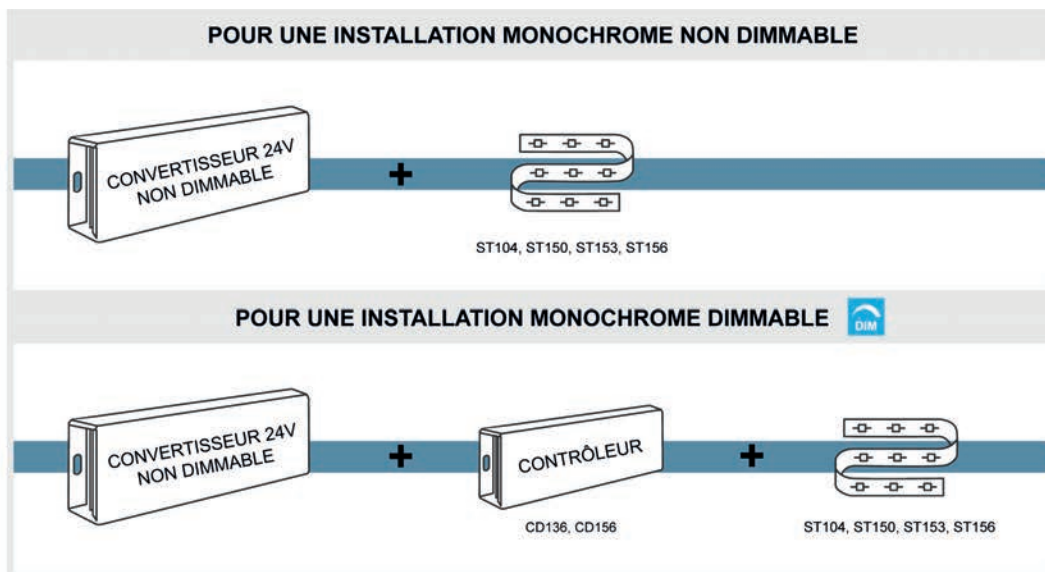

ST112



- Bandeau LED RGB.
- Rouleau 5m.
- Précâblé en début et fin de bandeau.
- Autocollant.
- Sécable toutes les 6 LEDs, 100mm.
- Convertisseur, contrôleur et accessoires à commander séparément.



ST112	PUISSANCE PAR MÈTRE	T°	L(MM)	€
ST112RGB	14,4W	RGB	5000	94,00

ACCESSOIRES	COULEUR	DESCRIPTION	€
ST118	BLANC	CONNECTEUR RGB	2,00
ST119	BLANC	INTERCONNECTEUR RGB	2,00
ST120	BLANC	CONNECTEUR L RGB	5,00
ST121	BLANC	CONNECTEUR T RGB	7,00
ST122	BLANC	CONNECTEUR X RGB	10,00

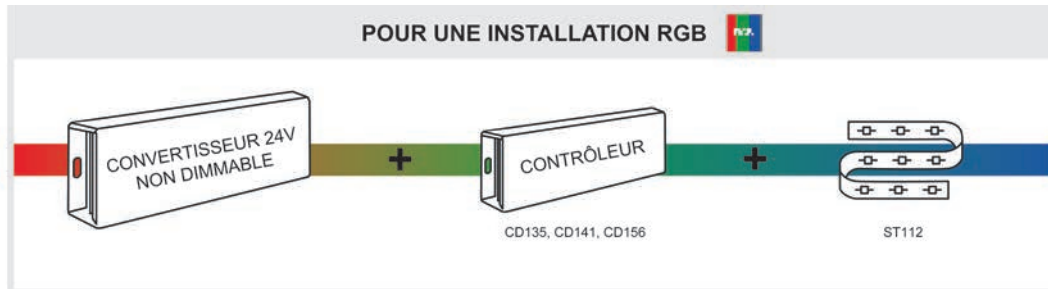



ST159

- Bandeau LED étanche (SMD 2835).
- Rouleau 5m.
- Précâblé en début et fin de bandeau.
- Autocollant.
- IP67 non coupé. Sécable toutes les 6 LEDs, 50mm.
- Accessoires inclus (5 embouts, 10 clips).
- Convertisseur à commander séparément.



ST159	PUISSANCE PAR MÈTRE	T°	FLUX LUMINEUX PAR MÈTRE	L(MM)	€
ST159SW	14,4W	2700K	1080Lm	5000	122,00
ST159WW	14,4W	3000K	1145Lm	5000	122,00
ST159NW	14,4W	4000K	1190Lm	5000	122,00
ST159CW	14,4W	6000K	1145Lm	5000	122,00

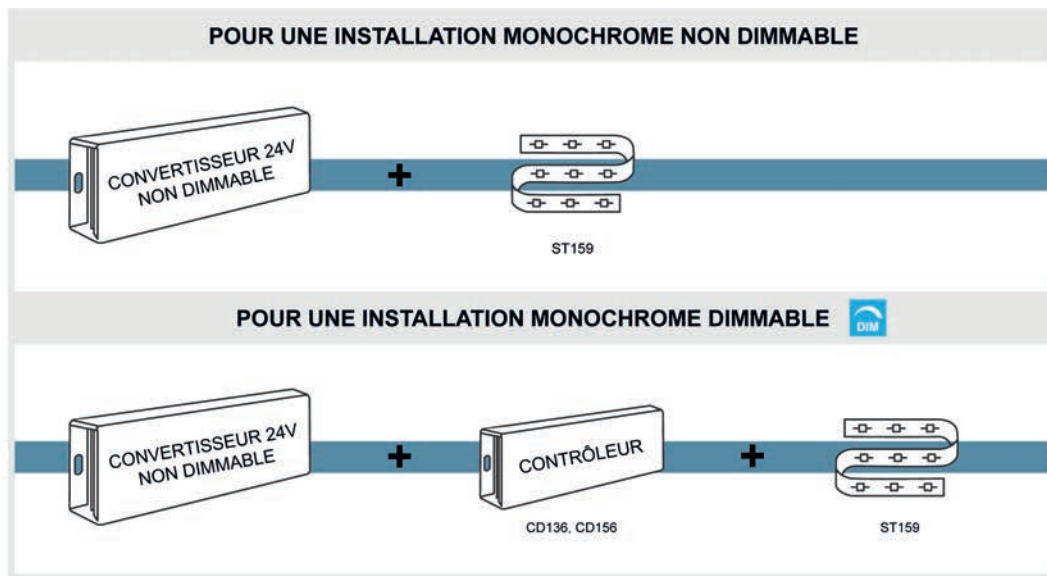

ST123



- Bandeau LED RGB étanche.
- Rouleau 5m.
- Précâblé en début et fin de bandeau.
- Autocollant.
- IP67 non coupé. Sécable toutes les 6 LEDs, 100mm.
- Accessoires inclus (5 embouts, 10 clips).
- Convertisseur et contrôleur à commander séparément.



ST123	PUISSANCE PAR MÈTRE	T°	L(MM)	€
ST123RGB	14,4W	RGB	5000	138,00

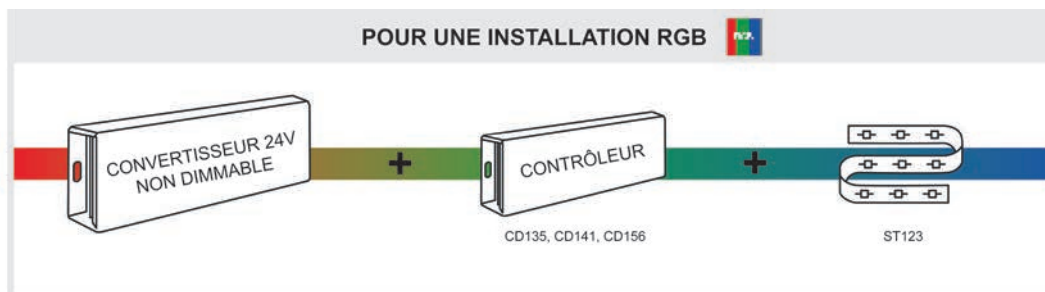



ST132

	CRI >90	2700K - 6000K	3
IP 33	24V DC		



- Bandeau LED blanc dynamique (SMD 2216).
- Rouleau 5m.
- Précâblé en début et fin de bandeau.
- Autocollant.
- Sécable toutes les 12 LEDs, 50mm.
- Convertisseur et contrôleur à commander séparément.

ST132	PUISSANCE PAR MÈTRE	T°	FLUX LUMINEUX PAR MÈTRE	L(MM)	€
ST132SWW	9,6W	2700K > 6000K	720Lm	5000	119,00

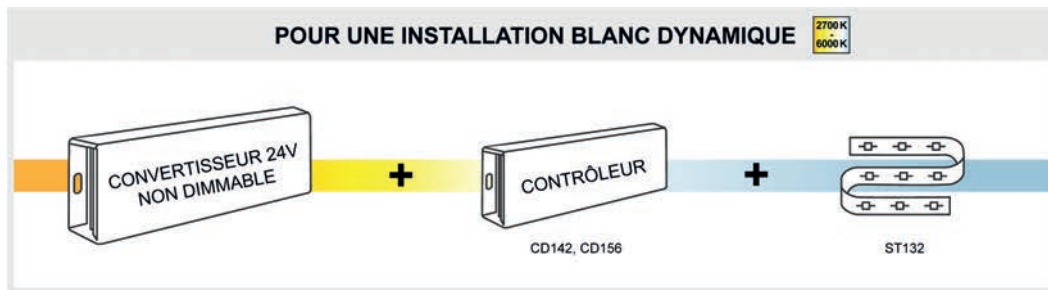



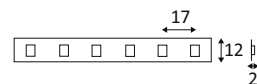

ST125



- Bandeau LED RGB+W (SMD 5050).
- Rouleau 5m.
- Précâblé en début et fin de bandeau.
- Autocollant.
- Sécable toutes les 6 LEDs, 100mm.
- Convertisseur, contrôleur et accessoires à commander séparément.

ST125	PUISSANCE PAR MÈTRE	T°	FLUX LUMINEUX PAR MÈTRE	L(MM)	€
ST125RGBW	19,2W	RGB + 6000K	320Lm	5000	148,00

ACCESSOIRES	COULEUR	DESCRIPTION		€
ST126	BLANC	CONNECTEUR RGBW		1,00
ST127	BLANC	INTERCONNECTEUR RGBW		2,00
ST128	BLANC	CONNECTEUR L RGBW		1,00
ST129	BLANC	CONNECTEUR T RGBW		1,00
ST130	BLANC	CONNECTEUR X RGBW		1,00

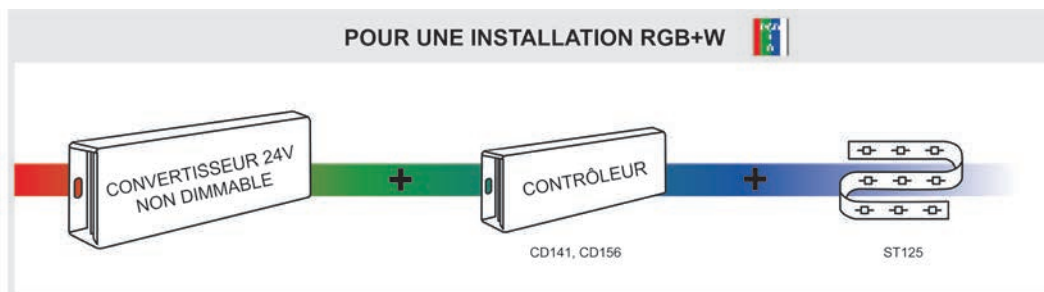



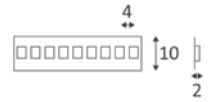

ST160



- Bandeau LED (SMD 2835).
- Rouleau 5m.
- Précâblé en début et fin de bandeau.
- Autocollant.
- Sécable toutes les 6 LEDs, 25mm.
- Convertisseur à commander séparément.

ST160	PUISSANCE PAR MÈTRE	T°	FLUX LUMINEUX PAR MÈTRE	L(MM)	€
ST160WW	22W	3000K	2460Lm	5000	120,00
ST160NW	22W	4000K	2495Lm	5000	120,00
ST160CW	22W	6000K	2460Lm	5000	120,00

ACCESSOIRES	DESCRIPTION	L(MM)		€
ST161	CONNECTEUR	24		10,00
ST162	INTERCONNECTEUR	19,5		10,00

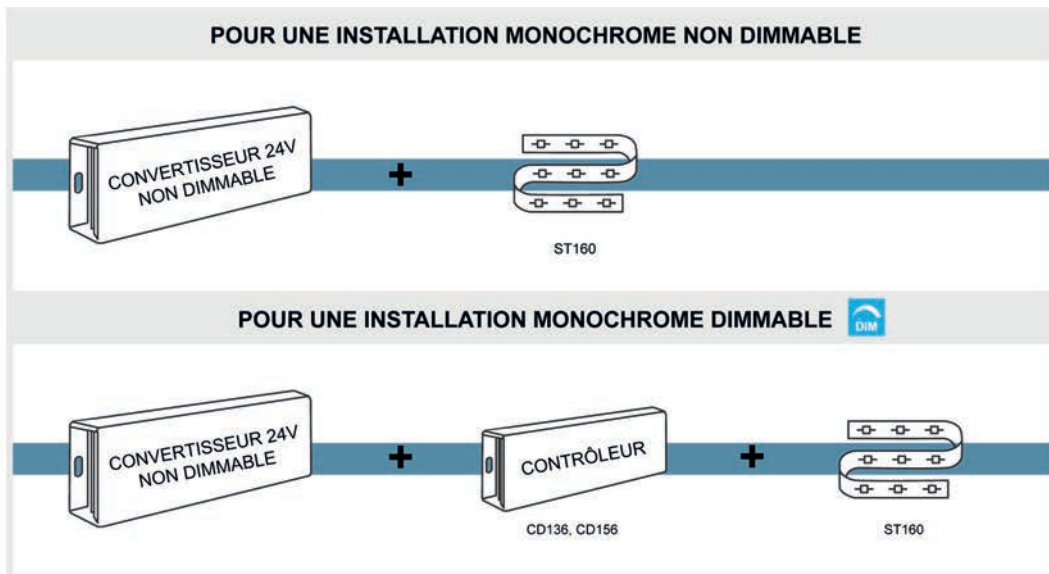



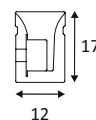







ST135



- Bandeau LED étanche (SMD 2835).
- Rouleau 5m. Précâblé en début de bandeau.
- Sécable tous les 50mm (uniquement 3000K et 4000K) et tous les 83mm (RGB).
- Convertisseur, contrôleur et accessoires à commander séparément.
- Accessoires compatibles uniquement avec ST135WW et ST135NW sauf profils et embout.

ST135	PUISSANCE PAR MÈTRE	T°	FLUX LUMINEUX PAR MÈTRE	L(MM)	€
ST135WW	9,6W	3000K	480Lm	5000	158,00
ST135NW	9,6W	4000K	510Lm	5000	158,00
ST135RGB	12W	RGB		5000	188,00

ACCESSOIRES	DESCRIPTION	L(MM)		€
WW - NW				
ST136	CONNECTEUR + CABLE FIN			12,00
ST137	CONNECTEUR + CABLE BAS			9,00
ST138	CONNECTEUR + CABLE GAUCHE			12,00
ST139	CONNECTEUR + CABLE DROIT			12,00
ST140	INTERCONNECTEUR			10,00
ST141	INTERCONNECTEUR + CABLE 30CM	300		21,00
WW - NW - RGB				
ST142	PROFIL FLEXIBLE L:0,5M 2PC	500		24,00
ST143	PROFIL PC L:1M	1000		7,00
ST144	PROFIL ALUMINIUM L:1M	1000		10,00
ST145	EMBOUT			7,00

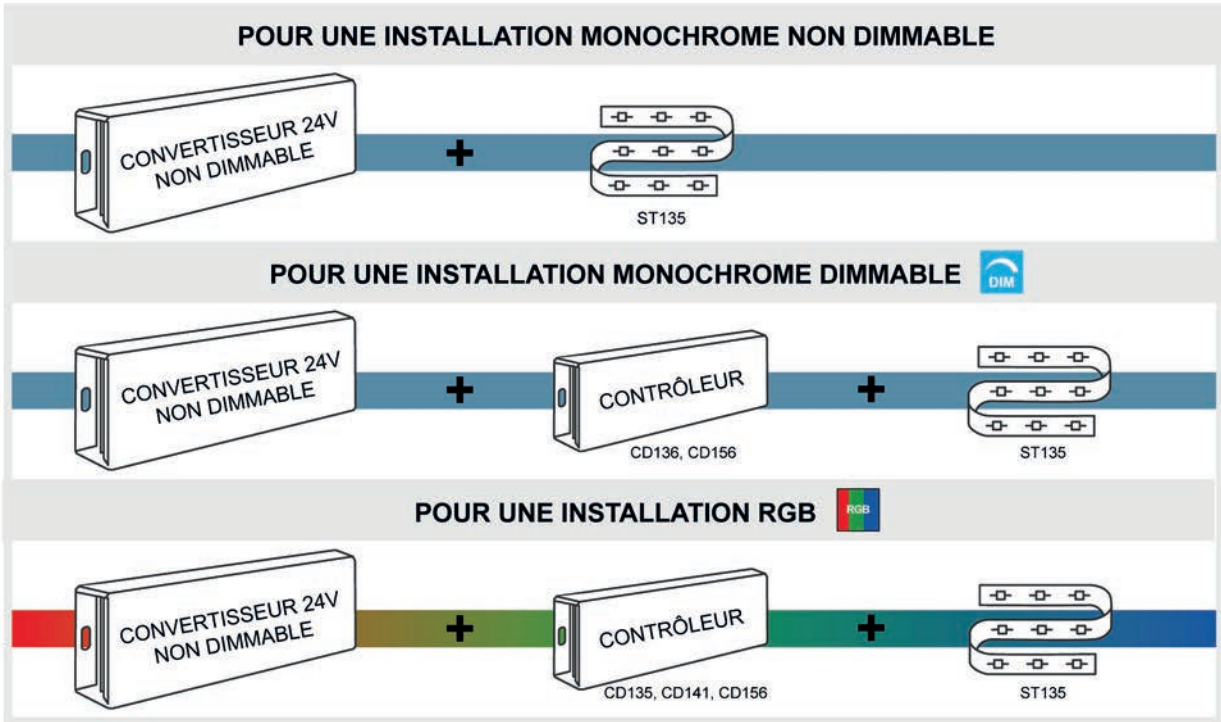

ST135



PR115

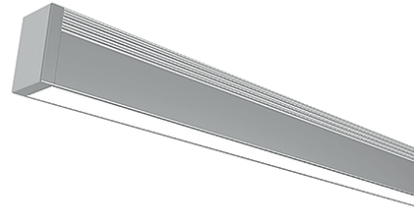
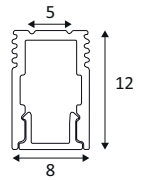

- Profil apparent pour bandeau LED.
- Compatible avec ST104.
- Diffuseur en polycarbonate, 2 embouts de finition fournis.
- Montage mural ou au plafond.
- Clips de montage, bandeau LED et convertisseur à commander séparément.

PR115	COULEUR	MATIÈRE	L(MM)	€
PR11530	BLANC MAT	ALUMINIUM	2000	35,00
PR11552	ALUMINIUM	ALUMINIUM	2000	35,00

ACCESSOIRES	COULEUR	MATIÈRE	DESCRIPTION	€
PR14052	ACIER INOXYDABLE	INOX 304	CLIPS DE MONTAGE 4PC	2,00
PR11630	BLANC MAT	POLYCARBONATE	EMBOUTS PERCES 2PC	4,00
PR11652	ALUMINIUM	POLYCARBONATE	EMBOUTS PERCES 2PC	4,00



BLANC MAT

ALUMINIUM





PROFILS

PR139

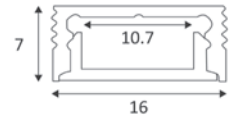

- Profil apparent pour bandeau LED.
- Compatible avec ST104, ST150, ST153, ST132.
- Diffuseur en polycarbonate, 2 embouts de finition fournis.
- Montage mural ou au plafond.
- Clips de montage, bandeau LED et convertisseur à commander séparément.

PR139	COULEUR	MATIÈRE	L(MM)	€		
PR13930		BLANC MAT	ALUMINIUM	2500	29,00	
PR13952		ALUMINIUM	ALUMINIUM	2500	29,00	
ACCESSOIRES	COULEUR	MATIÈRE	DESCRIPTION		€	
PR14152	ACIER INOXYDABLE	INOX 3 04	CLIPS DE MONTAGE 4PC			2,00
PR11952	ACIER INOXYDABLE	INOX 304	CLIPS DE MONTAGE 45° 4PC			5,00
PR12052	ACIER INOXYDABLE	INOX 304	CLIPS DE MONTAGE ORIENTABLES 0-180° 4PC			16,00
PR14530	BLANC MAT	POLYCARBONATE	EMBOUS PERCES 2PC			2,00
PR14552	ALUMINIUM	POLYCARBONATE	EMBOUS PERCES 2PC			3,00



BLANC MAT



ALUMINIUM



PR117

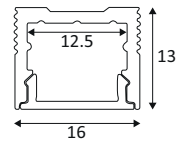

- Profil pour bandeau LED.
- Compatible avec ST104, ST150, ST153, ST125, ST160, ST132.
- Diffuseur en polycarbonate, 2 embouts de finition fournis.
- Montage apparent ou encastré (encastrement 16x13x2000mm).
- Clips de montage, bandeau LED et convertisseur à commander séparément.

PR117	COULEUR	MATIÈRE	L(MM)	€		
PR11730		BLANC MAT	ALUMINIUM	2000	45,00	
PR11752		ALUMINIUM	ALUMINIUM	2000	45,00	
ACCESSOIRES	COULEUR	MATIÈRE	DESCRIPTION		€	
PR14152	ACIER INOXYDABLE	INOX 304	CLIPS DE MONTAGE 4PC			2,00
PR11952	ACIER INOXYDABLE	INOX 304	CLIPS DE MONTAGE 45° 4PC			5,00
PR12052	ACIER INOXYDABLE	INOX 304	CLIPS DE MONTAGE ORIENTABLES 0-180° 4PC			16,00
PR11830	BLANC MAT	POLYCARBONATE	EMBOUTS PERCES 2PC			4,00
PR11852	ALUMINIUM	POLYCARBONATE	EMBOUTS PERCES 2PC			4,00





PROFILS

PR121

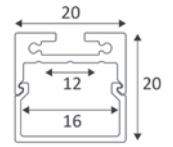
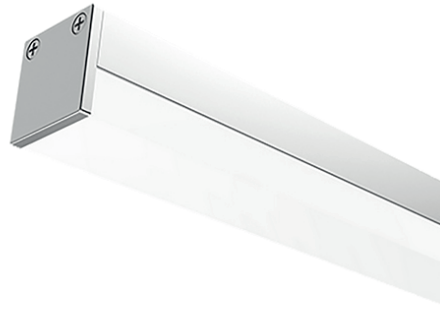
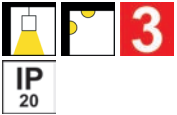

- Profil apparent pour bandeau LED.
- Compatible avec ST153, ST156, ST112, ST159, ST123, ST132.
- Diffuseur en polycarbonate, 2 embouts de finition fournis.
- Montage mural, au plafond ou en suspension.
- Clips de montage, bandeau LED et convertisseur à commander séparément.

PR121	COULEUR	MATIÈRE	L(MM)	€
PR12130	BLANC MAT	ALUMINIUM	2000	61,00
PR12152	ALUMINIUM	ALUMINIUM	2000	61,00
ACCESSOIRES	COULEUR	MATIÈRE	DESCRIPTION	€
PR14252	ACIER INOXYDABLE	INOX 304	CLIPS DE MONTAGE 4PC	4,00
PR12452	ALUMINIUM	ALUMINIUM	CONNECTEURS L:55MM 4PC	14,00
PR12230	BLANC MAT	POLYCARBONATE	EMBOUTS PERCES 2PC	5,00
PR12252	ALUMINIUM	POLYCARBONATE	EMBOUTS PERCES 2PC	5,00
PR12330	BLANC MAT	ALUMINIUM	KIT SUSPENSION L:2000MM	49,00
PR12352	ALUMINIUM	ALUMINIUM	KIT SUSPENSION L:2000MM	49,00



BLANC MAT

ALUMINIUM



PR127

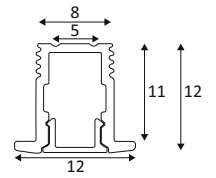
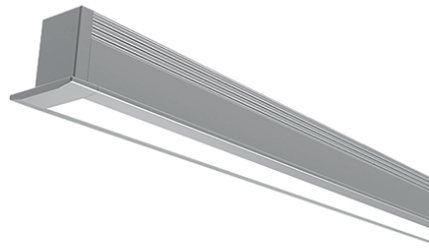

- Profil encastrable pour bandeau LED.
- Compatible avec ST104.
- Encastrement 10x13x2000mm.
- Diffuseur en polycarbonate, 2 embouts de finition fournis.
- Bandeau LED et convertisseur à commander séparément.

PR127	COULEUR	MATIÈRE	L(MM)	€
PR12730	BLANC MAT	ALUMINIUM	2000	35,00
PR12752	ALUMINIUM	ALUMINIUM	2000	35,00
ACCESSOIRES	COULEUR	MATIÈRE	DESCRIPTION	€
PR12952	ACIER INOXYDABLE	INOX 304	ETRIERS D'ENCASTREMENT 4PC	3,00
PR12830	BLANC MAT	POLYCARBONATE	EMBOUTS PERCES 2PC	4,00
PR12852	ALUMINIUM	POLYCARBONATE	EMBOUTS PERCES 2PC	4,00

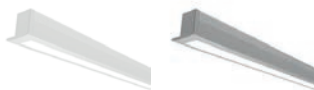

BLANC MAT

ALUMINIUM





PROFILS

PR130

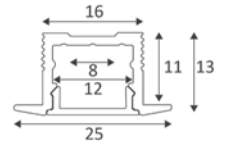
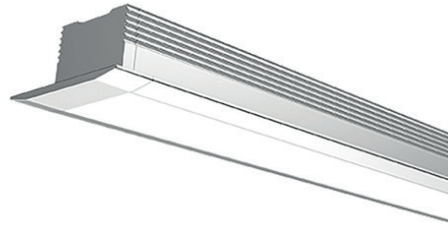

- Profil encastrable pour bandeau LED.
- Compatible avec ST104, ST150, ST153, ST125, ST160, ST132.
- Encastrement 19x13x2000mm.
- Diffuseur en polycarbonate, 2 embouts de finition fournis.
- Bandeau LED et convertisseur à commander séparément.

PR130	COULEUR	MATIÈRE	L(MM)	€
PR13030	BLANC MAT	ALUMINIUM	2000	50,00
PR13052	ALUMINIUM	ALUMINIUM	2000	50,00
ACCESSOIRES	COULEUR	MATIÈRE	DESCRIPTION	€
PR13130	BLANC MAT	POLYCARBONATE	EMBOUITS PERCES 2PC	5,00
PR13152	ALUMINIUM	POLYCARBONATE	EMBOUITS PERCES 2PC	4,00
PR13252	ACIER INOXYDABLE	INOX 304	ETRIERS D'ENCASTREMENT 4PC	3,00



BLANC MAT

ALUMINIUM

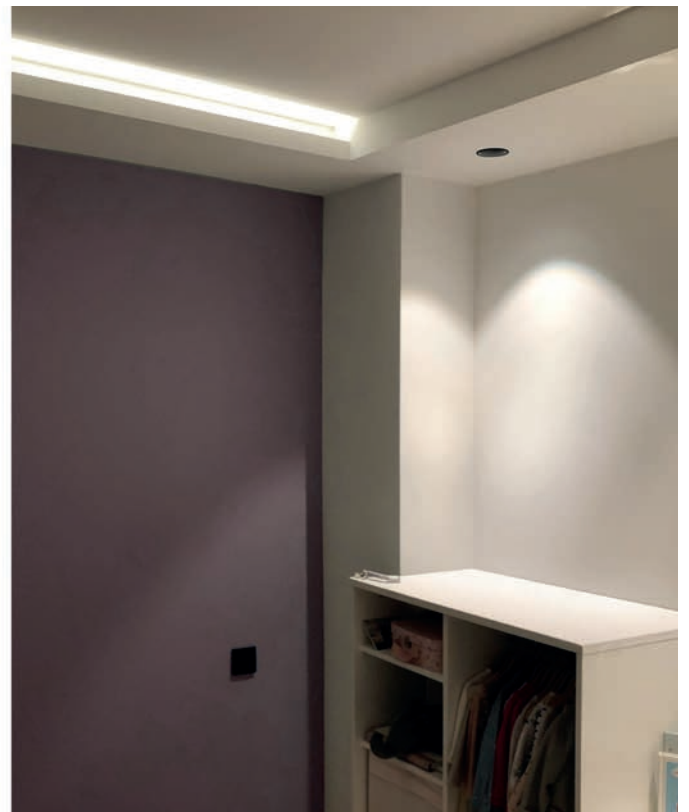

PR146



- Profil encastrable pour bandeau LED.
- Encastrement 22x12x2500mm.
- Compatible avec ST159, ST123.
- Diffuseur en polycarbonate, 2 embouts de finition fournis.
- Bandeau LED et convertisseur à commander séparément.

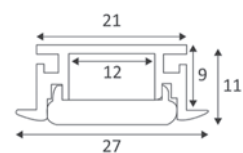

PR146	COULEUR	MATIÈRE	L(MM)	€
PR14652		ALUMINIUM	2500	53,00
ACCESSOIRES	COULEUR	MATIÈRE	DESCRIPTION	€
PR14752	ALUMINIUM	POLYCARBONATE	EMBOUS 2PC	1,00





PROFILS

PR133



- Profil apparent pour bandeau LED.
- Compatible avec ST150, ST153, ST132.
- Diffuseur en polycarbonate, 2 embouts de finition fournis.
- Montage mural.
- Clips de montage, bandeau LED et convertisseur à commander séparément.

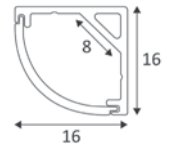
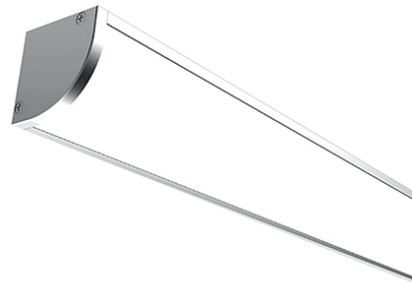

PR133	COULEUR	MATIÈRE	L(MM)	€
PR13330	BLANC MAT	ALUMINIUM	2000	43,00
PR13352	ALUMINIUM	ALUMINIUM	2000	43,00
ACCESSOIRES	COULEUR	MATIÈRE	DESCRIPTION	€
PR14352	ACIER INOXYDABLE	INOX 304	CLIPS DE MONTAGE 4PC	4,00
PR14340	BLANC MAT	POLYCARBONATE	EMBOUTS PERCES 2PC	4,00
PR13452	ALUMINIUM	POLYCARBONATE	EMBOUTS PERCES 2PC	4,00



BLANC MAT

ALUMINIUM



PR135



- Profil apparent pour bandeau LED.
- Compatible avec ST150, ST153, ST132.
- Diffuseur en polycarbonate, 2 embouts de finition fournis.
- Montage mural.
- Clips de montage, bandeau LED et convertisseur à commander séparément.

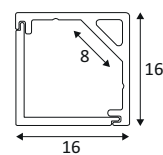
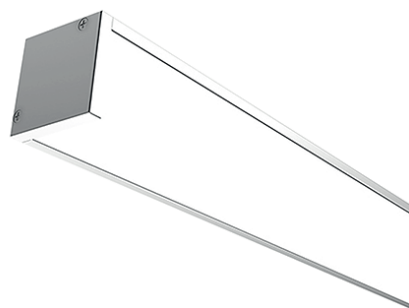

PR135	COULEUR	MATIÈRE	L(MM)	€
PR13530	BLANC MAT	ALUMINIUM	2000	45,00
PR13552	ALUMINIUM	ALUMINIUM	2000	45,00
ACCESSOIRES	COULEUR	MATIÈRE	DESCRIPTION	€
PR14352	ACIER INOXYDABLE	INOX 304	CLIPS DE MONTAGE 4PC	4,00
PR13630	BLANC MAT	POLYCARBONATE	EMBOUTS PERCES 2PC	4,00
PR13652	ALUMINIUM	POLYCARBONATE	EMBOUTS PERCES 2PC	4,00

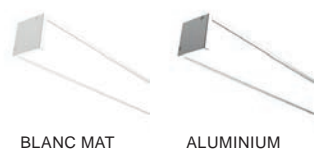



PROFILS

PR137

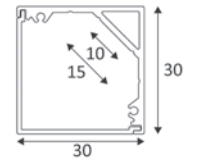
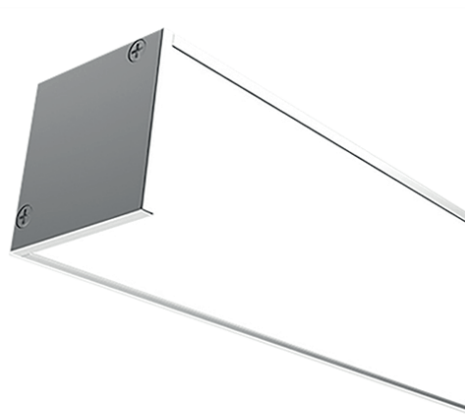

- Profil apparent pour bandeau LED.
- Compatible avec ST156, ST112, ST159, ST123, ST125, ST160.
- Diffuseur en polycarbonate, 2 embouts de finition fournis.
- Montage mural.
- Clips de montage, bandeau LED et convertisseur à commander séparément.

PR137	COULEUR	MATIÈRE	L(MM)	€
PR13730	BLANC MAT	ALUMINIUM	2000	76,00
PR13752	ALUMINIUM	ALUMINIUM	2000	76,00

ACCESSOIRES	COULEUR	MATIÈRE	DESCRIPTION	€
PR14452	ACIER INOXYDABLE	INOX 304	CLIPS DE MONTAGE 4PC	4,00
PR13830	BLANC MAT	POLYCARBONATE	EMBOUTS PERCES 2PC	5,00
PR13852	ALUMINIUM	POLYCARBONATE	EMBOUTS PERCES 2PC	5,00

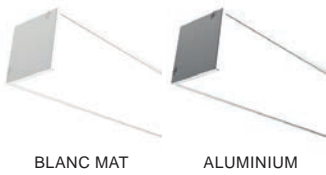

BLANC MAT

ALUMINIUM



INDIGO

LIGHTING



RAILS & PROJECTEURS 1 ALLUMAGE



TRACK UNO

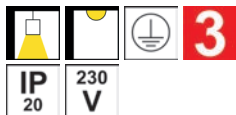

- Rail apparent.
- Tension secteur 220/250V.
- Le raccordement au monophasé autorise une intensité totale de 16A, qui correspond à 3680VA.
- Le rail peut supporter une charge de 10kg maximum entre 2 points de fixation.
- La pièce de renfort TR411 peut s'adapter au kit de suspension TR412.

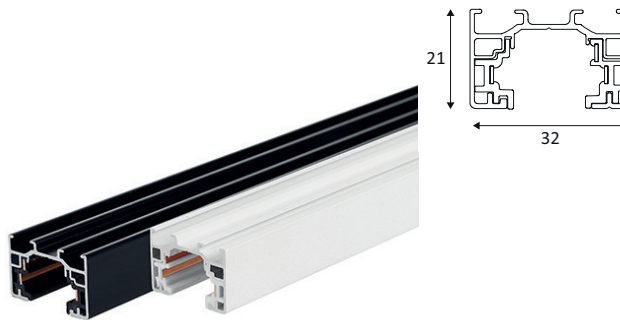

TRACK UNO	COULEUR	MATIÈRE	WATT MAX	L(MM)	€
TR40104	BLANC	ALUMINIUM	3680VA	2000	73,00
TR40105	NOIR	ALUMINIUM	3680VA	2000	73,00
TR40204	BLANC	ALUMINIUM	3680VA	3000	109,00
TR40205	NOIR	ALUMINIUM	3680VA	3000	109,00



BLANC

NOIR

ENTRAXES DE FIXATION



CHARGE SUPPORTÉE

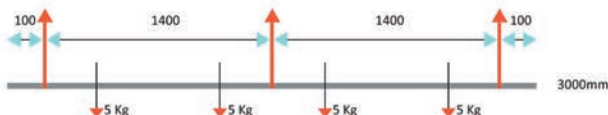
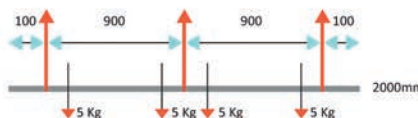

MONOPHASE

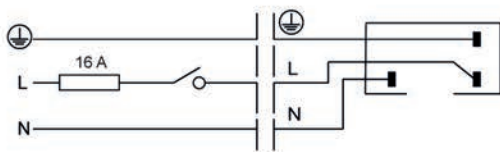

VUE EN PLAN

Les accessoires sont reliés aux rails de manière à assurer la continuité électrique et mécanique de l'installation, ainsi que la continuité de la mise à la terre.

La position latérale du fil de mise à la terre rend la structure asymétrique et, de ce fait, les raccords de connexion sont orientés gauche-droite ou intérieur-extérieur.

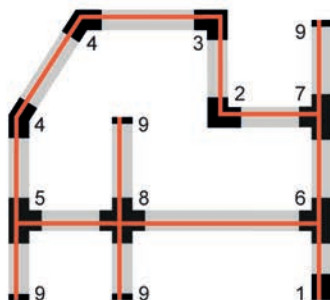

- 1 ALIMENTATION GAUCHE
- 2 CONNEXION L 90° INTERIEURE
- 3 CONNEXION L 90° EXTERIEURE
- 4 CONNEXION 20-180° INTERIEURE
- 5 CONNEXION T EXTERIEURE DROITE
- 6 CONNEXION T INTERIEURE GAUCHE
- 7 CONNEXION T INTERIEURE DROITE
- 8 CONNEXION EN CROIX
- 9 EMBOUT DE FINITION





TRACK UNO

ALIMENTATION DROITE

	€
TR40304 	6,00
TR40305 	6,00

ALIMENTATION GAUCHE

TR40404 	6,00
TR40405 	6,00

ALIMENTATION CENTRALE

TR40504 	13,00
TR40505 	13,00



CONNEXION ELECTRIQUE

TR40604 	9,00
TR40605 	9,00

CONNEXION L 90° INTERIEURE

TR40704 	13,00
TR40705 	13,00

CONNEXION L 90° EXTERIEURE

TR40804 	13,00
TR40805 	13,00



CONNEXION 20-180° INTERIEURE

TR40904 	24,00
TR40905 	24,00

CONNEXION 20-180° EXTERIEURE

TR42104 	27,00
TR42105 	27,00

CONNEXION T INTERIEURE DROITE

TR44104 	16,00
TR44105 	16,00

CONNEXION T EXTERIEURE DROITE

TR44004 	16,00
TR44005 	16,00



CONNEXION T INTERIEURE GAUCHE

TR44304 	16,00
TR44305 	16,00



CONNEXION T EXTERIEURE GAUCHE

TR44204 	16,00
TR44205 	16,00



CONNEXION EN CROIX

TR44404 	23,00
TR44405 	23,00



ADAPTATEUR 6A AVEC TUBE FILETE M10 MAX 5KG

TR41004 	6,00
TR41005 	6,00

PIECE DE RENFORT L:8CM

TR41120 	10,00
TR41104 	9,00
TR41105 	9,00

KIT SUSPENSION L:150CM

TR41204 	21,00
TR41205 	21,00

EMBOUT DE FINITION

TR41304 	1,00
TR41305 	1,00

MOULURE DE FINITION L:200CM

TR41404 	18,00
---	-------

MOULURE DE FINITION L:300CM

TR41405 	18,00
TR41504 	27,00
TR41505 	27,00

YERA 1 T GU10

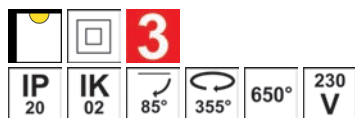

- Projecteur pour éclairage d'accentuation.
- Adaptateur pour Track UNO.

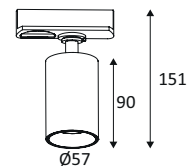

YERA 1 T GU10	COULEUR	MATIÈRE	SOQUET	LAMPE	WATT MAX	€
TR43105	■ NOIR MAT	ALUMINIUM	GU10	PAR16 LED	10W	40,00
TR43130	■ BLANC MAT	ALUMINIUM	GU10	PAR16 LED	10W	40,00



NOIR MAT

BLANC MAT

YERA 1 TP GU10



- Suspension décorative.
- Adaptateur pour Track UNO.
- Livrée avec câble d'alimentation textile noir ou blanc (réglable 1.50m max).

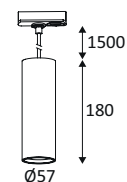

YERA 1 TP GU10	COULEUR	MATIÈRE	SOQUET	LAMPE	WATT MAX	€
TR43205	■ NOIR MAT	ALUMINIUM	GU10	PAR16 LED	10W	69,00
TR43230	■ BLANC MAT	ALUMINIUM	GU10	PAR16 LED	10W	69,00



NOIR MAT

BLANC MAT

YERA 1 TP GU10



OKTO T GU10

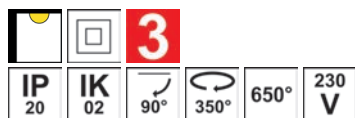

- Projecteur pour éclairage d'accentuation.
- Adaptateur pour Track UNO.

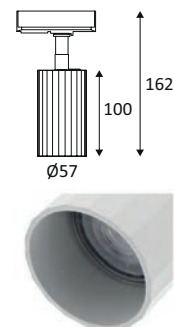
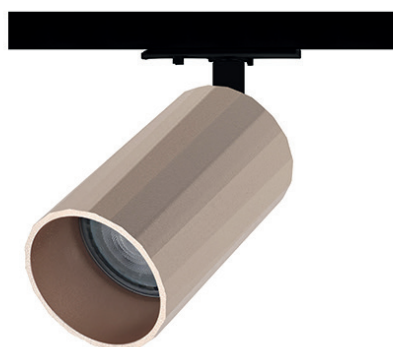

OKTO T GU10	COULEUR	MATIÈRE	SOQUET	LAMPE	WATT MAX	€
TR41905	NOIR MAT	ALUMINIUM	GU10	PAR16 LED	10W	52,00
TR41908	NOIR MAT - CHAMPAGNE	ALUMINIUM	GU10	PAR16 LED	10W	57,00
TR41906	NOIR MAT - OR ROSE	ALUMINIUM	GU10	PAR16 LED	10W	57,00
TR41983	NOIR MAT - ROSE	ALUMINIUM	GU10	PAR16 LED	10W	57,00
TR41930	BLANC MAT	ALUMINIUM	GU10	PAR16 LED	10W	52,00
TR41949	BLANC MAT - CHAMPAGNE	ALUMINIUM	GU10	PAR16 LED	10W	57,00
TR41902	BLANC MAT - OR ROSE	ALUMINIUM	GU10	PAR16 LED	10W	57,00
TR41982	BLANC MAT - ROSE	ALUMINIUM	GU10	PAR16 LED	10W	57,00

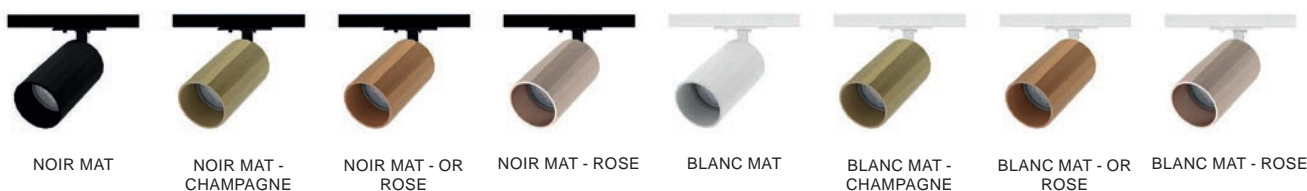

OKTO TP GU10



- Suspension décorative.
- Adaptateur pour Track UNO.
- Livrée avec câble d'alimentation textile (réglable 1.50m max).
- Coloris 05 - 08 - 06 - 83 : câble noir.
- Coloris 30 - 49 - 02 - 82 : câble blanc.

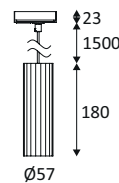
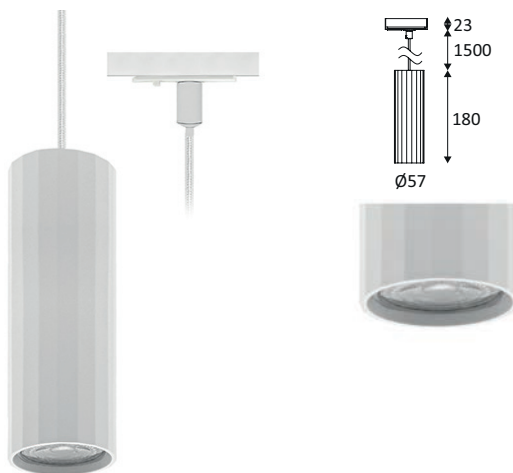

OKTO TP GU10	COULEUR	MATIÈRE	SOQUET	LAMPE	WATT MAX	€
TR42005	NOIR MAT	ALUMINIUM	GU10	PAR16 LED	10W	73,00
TR42008	NOIR MAT - CHAMPAGNE	ALUMINIUM	GU10	PAR16 LED	10W	77,00
TR42006	NOIR MAT - OR ROSE	ALUMINIUM	GU10	PAR16 LED	10W	77,00
TR42083	NOIR MAT - ROSE	ALUMINIUM	GU10	PAR16 LED	10W	77,00
TR42030	BLANC MAT	ALUMINIUM	GU10	PAR16 LED	10W	73,00
TR42049	BLANC MAT - CHAMPAGNE	ALUMINIUM	GU10	PAR16 LED	10W	77,00
TR42002	BLANC MAT - OR ROSE	ALUMINIUM	GU10	PAR16 LED	10W	77,00
TR42082	BLANC MAT - ROSE	ALUMINIUM	GU10	PAR16 LED	10W	77,00





OKTO TP GU10



JACK T

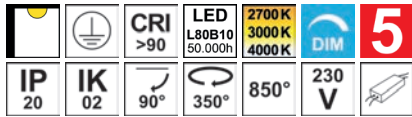

- Projecteur pour éclairage d'accentuation.
- Adaptateur pour Track UNO.
- 2700K, 3000K ou 4000K au choix via un interrupteur à l'arrière du luminaire.
- Convertisseur dimmable intégré dans l'appareil.
- Compatible avec variateur fin de phase.

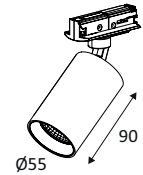

JACK T	COULEUR	MATIÈRE	P	T°	LED LUMEN	SYSTEM LUMEN	α	€
TR42805	NOIR MAT	ALUMINIUM	10W	2700K 3000K 4000K	1120Lm (4000K)	770Lm (4000K)	38°	74,00
TR42813	NOIR MAT - LAITON	ALUMINIUM	10W	2700K 3000K 4000K	1120Lm (4000K)	770Lm (4000K)	38°	75,00
TR42806	NOIR MAT - OR ROSE	ALUMINIUM	10W	2700K 3000K 4000K	1120Lm (4000K)	770Lm (4000K)	38°	93,00
TR42830	BLANC MAT	ALUMINIUM	10W	2700K 3000K 4000K	1120Lm (4000K)	770Lm (4000K)	38°	74,00
TR42828	BLANC MAT - LAITON	ALUMINIUM	10W	2700K 3000K 4000K	1120Lm (4000K)	770Lm (4000K)	38°	93,00
TR42802	BLANC MAT - OR ROSE	ALUMINIUM	10W	2700K 3000K 4000K	1120Lm (4000K)	770Lm (4000K)	38°	93,00



NOIR MAT

NOIR MAT - LAITON

NOIR MAT - OR ROSE

BLANC MAT

BLANC MAT - LAITON

BLANC MAT - OR ROSE





JACK TP

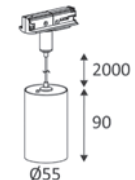
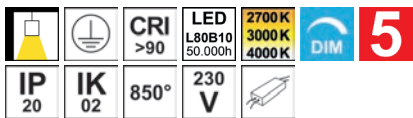

- Suspension décorative.
- Adaptateur pour Track UNO.
- Livrée avec câble d'alimentation (réglable 2.00m max).
- Coloris 05 - 13 - 06 : câble noir.
- Coloris 30 - 28 - 02 : câble blanc.
- 2700K, 3000K ou 4000K au choix via un interrupteur à l'arrière du luminaire.
- Convertisseur dimmable intégré dans l'appareil.
- Compatible avec variateur fin de phase.



JACK TP	COULEUR	MATIÈRE	P	T°	LED LUMEN	SYSTEM LUMEN	α	€
TR42905	NOIR MAT	ALUMINIUM	10W	2700K 3000K 4000K	1120Lm (4000K)	770Lm (4000K)	38°	79,00
TR42913	NOIR MAT - LAITON	ALUMINIUM	10W	2700K 3000K 4000K	1120Lm (4000K)	770Lm (4000K)	38°	98,00
TR42906	NOIR MAT - OR ROSE	ALUMINIUM	10W	2700K 3000K 4000K	1120Lm (4000K)	770Lm (4000K)	38°	98,00
TR42930	BLANC MAT	ALUMINIUM	10W	2700K 3000K 4000K	1120Lm (4000K)	770Lm (4000K)	38°	79,00
TR42928	BLANC MAT - LAITON	ALUMINIUM	10W	2700K 3000K 4000K	1120Lm (4000K)	770Lm (4000K)	38°	98,00
TR42902	BLANC MAT - OR ROSE	ALUMINIUM	10W	2700K 3000K 4000K	1120Lm (4000K)	770Lm (4000K)	38°	98,00



RAY

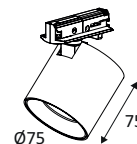
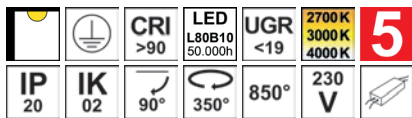

- Projecteur pour éclairage d'accentuation.
- Adaptateur pour Track UNO.
- 2700K, 3000K ou 4000K au choix via un interrupteur à l'arrière du luminaire.
- Convertisseur non dimmable ou dimmable intégré dans l'appareil.

RAY	COULEUR	MATIÈRE	P	T°	LED LUMEN	SYSTEM LUMEN	α	€
NON DIMMABLE								
TR41805	■ NOIR MAT	ALUMINIUM	13W	2700K 3000K 4000K	1405Lm (4000K)	995Lm (4000K)	38°	93,00
TR41830	■ BLANC MAT	ALUMINIUM	13W	2700K 3000K 4000K	1405Lm (4000K)	1015Lm (4000K)	38°	93,00
DIMMABLE COUPURE DE PHASE								
TR43005	■ NOIR MAT	ALUMINIUM	15W	2700K 3000K 4000K	1580Lm (4000K)	1050Lm (4000K)	38°	106,00
TR43030	■ BLANC MAT	ALUMINIUM	15W	2700K 3000K 4000K	1580Lm (4000K)	1050Lm (4000K)	38°	106,00



NOIR MAT

BLANC MAT



RAY



INDIGO

LIGHTING



RAILS & PROJECTEURS 3 ALLUMAGES



TRACK III SURFACE

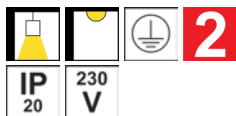

- Rail apparent.
- Tension secteur 220/250V.
- Le raccordement au triphasé autorise une intensité totale de 16A sur chaque circuit, ce qui correspond à $3 \times 3680VA = 11040VA$.
- Un rail peut supporter une charge de 6kg/0.20m avec une distance max de 1.00m entre les points de fixation ou une charge de 3kg/0.20m avec une distance max de 2.00m entre les points de fixation.

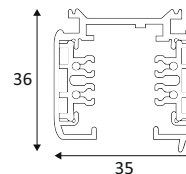

TRACK III SURFACE	COULEUR	MATIÈRE	WATT MAX	L(MM)	€
TR22030	■ NOIR	ALUMINIUM	(3X) 3680VA	1000	35,00
TR22031	■ BLANC	ALUMINIUM	(3X) 3680VA	1000	35,00
TR22130	■ NOIR	ALUMINIUM	(3X) 3680VA	2000	68,00
TR22131	■ BLANC	ALUMINIUM	(3X) 3680VA	2000	68,00
TR22230	■ NOIR	ALUMINIUM	(3X) 3680VA	3000	101,00
TR22231	■ BLANC	ALUMINIUM	(3X) 3680VA	3000	101,00



NOIR

BLANC

CHARGE POIDS D'INSTALLATION

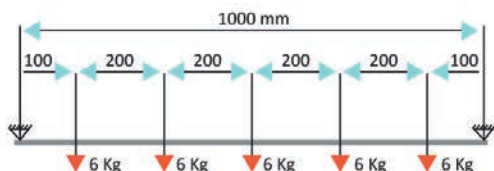

TRIPHASE

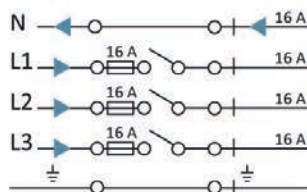

MONOPHASE

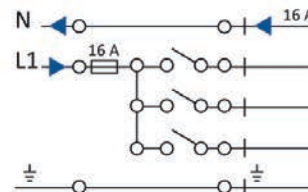

VUE EN PLAN

Les accessoires sont reliés aux rails de manière à assurer la continuité électrique et mécanique de l'installation, ainsi que la continuité de la mise à la terre.

La position latérale du fil de mise à la terre rend la structure asymétrique et, de ce fait, les raccords de connexion sont orientés gauche-droite ou intérieur-extérieur.

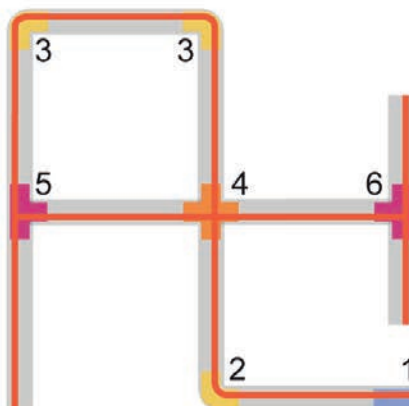

- 1 ALIMENTATION DROITE
- 2 CONNEXION L 90° INTÉRIEURE
- 3 CONNEXION L 90° EXTÉRIEURE
- 4 CONNEXION EN CROIX
- 5 CONNEXION T DROITE
- 6 CONNEXION T GAUCHE





TRACK III SURFACE

		€			€			€			
ALIMENTATION DROITE			CONNEXION EN CROIX			KIT FIXATION PLAFOND					
TR22330			17,00	TR23030			48,00	TR23530			5,00
TR22331			16,00	TR23031			48,00	TR23531			5,00
ALIMENTATION GAUCHE			CONNEXION T DROITE			KIT SUSPENSION L:500CM					
TR22430			16,00	TR23130			41,00	TR23630			22,00
TR22431			16,00	TR23131			41,00	TR23631			21,00
ALIMENTATION CENTRALE			CONNEXION T GAUCHE			PIECE DE RENFORT L:18CM					
TR22530			28,00	TR23230			41,00	TR23930			11,00
TR22531			28,00	TR23231			41,00	TR23931			11,00
CONNEXION ELECTRIQUE			CONNEXION ELECTRIQUE SOUPLE			EMBOUT DE FINITION					
TR22630			9,00	TR36030			36,00	TR23730			2,00
TR22631			9,00	TR36031			36,00	TR23731			2,00
CONNEXION MECANIQUE			ADAPTATEUR MECANIQUE MAX. 10KG			MOULURE DE FINITION L:300CM					
TR22730			7,00	TR23330			13,00	TR23830			6,00
TR22731			7,00	TR23331			13,00	TR23831			6,00
CONNEXION L 90° INTERIEURE			ADAPTATEUR 10A MAX 5KG								
TR22830			28,00	TR23430			12,00				
TR22831			28,00	TR23431			12,00				
CONNEXION L 90° EXTERIEURE			CROCHET DE SUSPENSION MAX. 15KG								
TR22930			28,00	TR24030			2,00				
TR22931			29,00	TR24031			2,00				

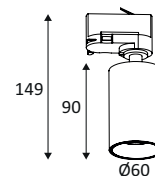
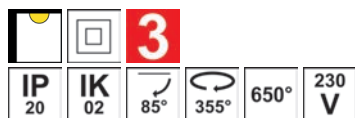
YERA GU10



- Projecteur pour éclairage d'accentuation.
- Adaptateur pour Track III SURFACE.
- Base apparente TR241 à commander séparément.

YERA GU10	COULEUR	MATIÈRE	SOQUET	LAMPE	WATT MAX	€
TR35905	■ NOIR MAT	ALUMINIUM	GU10	PAR16 LED	10W	51,00
TR35930	■ BLANC MAT	ALUMINIUM	GU10	PAR16 LED	10W	51,00
ACCESSOIRES	COULEUR	DESCRIPTION				€
TR24130	■ NOIR	BASE APPARENTE				29,00
TR24131	■ BLANC	BASE APPARENTE				29,00



NOIR MAT



BLANC MAT



YERA GU10



OKTO 3 T GU10

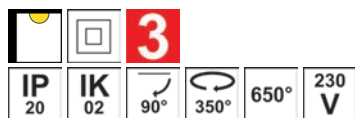

- Projecteur pour éclairage d'accentuation.
- Adaptateur pour Track III SURFACE.
- Base apparente TR241 à commander séparément.

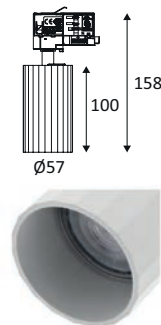

OKTO 3 T GU10	COULEUR	MATIÈRE	SOQUET	LAMPE	WATT MAX	€
TR42205	NOIR MAT	ALUMINIUM	GU10	PAR16 LED	10W	51,00
TR42208	NOIR MAT - CHAMPAGNE	ALUMINIUM	GU10	PAR16 LED	10W	57,00
TR42206	NOIR MAT - OR ROSE	ALUMINIUM	GU10	PAR16 LED	10W	57,00
TR42283	NOIR MAT - ROSE	ALUMINIUM	GU10	PAR16 LED	10W	57,00
TR42230	BLANC MAT	ALUMINIUM	GU10	PAR16 LED	10W	51,00
TR42249	BLANC MAT - CHAMPAGNE	ALUMINIUM	GU10	PAR16 LED	10W	57,00
TR42202	BLANC MAT - OR ROSE	ALUMINIUM	GU10	PAR16 LED	10W	57,00
TR42282	BLANC MAT - ROSE	ALUMINIUM	GU10	PAR16 LED	10W	57,00

ACCESSOIRES	COULEUR	DESCRIPTION	€
TR24130	NOIR	BASE APPARENTE	29,00
TR24131	BLANC	BASE APPARENTE	29,00





OKTO 3 TP GU10



- Suspension décorative.
- Adaptateur pour Track III SURFACE.
- Livrée avec câble d'alimentation textile (réglable 1.50m max).
- Coloris 05 - 08 - 06 - 83 : câble noir.
- Coloris 30 - 49 - 02 - 82 : câble blanc.



OKTO 3 TP GU10	COULEUR	MATIÈRE	SOQUET	LAMPE	WATT MAX	€
TR42305	■ NOIR MAT	ALUMINIUM	GU10	PAR16 LED	10W	65,00
TR42308	■ NOIR MAT - CHAMPAGNE	ALUMINIUM	GU10	PAR16 LED	10W	80,00
TR42306	■ NOIR MAT - OR ROSE	ALUMINIUM	GU10	PAR16 LED	10W	80,00
TR42383	■ NOIR MAT - ROSE	ALUMINIUM	GU10	PAR16 LED	10W	80,00
TR42330	■ BLANC MAT	ALUMINIUM	GU10	PAR16 LED	10W	67,00
TR42349	■ BLANC MAT - CHAMPAGNE	ALUMINIUM	GU10	PAR16 LED	10W	80,00
TR42302	■ BLANC MAT - OR ROSE	ALUMINIUM	GU10	PAR16 LED	10W	80,00
TR42382	■ BLANC MAT - ROSE	ALUMINIUM	GU10	PAR16 LED	10W	80,00



AUREA 3 T

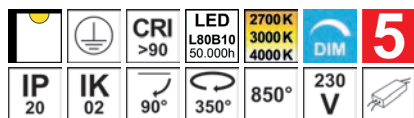

- Projecteur pour éclairage d'accentuation.
- Adaptateur pour Track III SURFACE.
- 2700K, 3000K ou 4000K au choix via un interrupteur à l'arrière du luminaire.
- Convertisseur dimmable intégré dans l'appareil.
- Compatible avec variateur début de phase.
- Réserver une phase spécifique du rail pour les produits dimmables.
- Base apparente TR241 à commander séparément.



AUREA 3 T	COULEUR	MATIÈRE	P	T°	LED LUMEN	SYSTEM LUMEN	α	€
TR43305	NOIR MAT	ALUMINIUM	6W	2700K 3000K 4000K	715Lm (4000K)	550Lm (4000K)	38°	79,00
TR43308	NOIR MAT - CHAMPAGNE	ALUMINIUM	6W	2700K 3000K 4000K	715Lm (4000K)	550Lm (4000K)	38°	79,00
TR43383	NOIR MAT - ROSE	ALUMINIUM	6W	2700K 3000K 4000K	715Lm (4000K)	550Lm (4000K)	38°	95,00
TR43330	BLANC MAT	ALUMINIUM	6W	2700K 3000K 4000K	715Lm (4000K)	550Lm (4000K)	38°	79,00
TR43349	BLANC MAT - CHAMPAGNE	ALUMINIUM	6W	2700K 3000K 4000K	715Lm (4000K)	550Lm (4000K)	38°	95,00
TR43382	BLANC MAT - ROSE	ALUMINIUM	6W	2700K 3000K 4000K	715Lm (4000K)	550Lm (4000K)	38°	95,00
ACCESSOIRES	COULEUR	DESCRIPTION						€
TR24130	NOIR	BASE APPARENTE						29,00
TR24131	BLANC	BASE APPARENTE						29,00



NOIR MAT

NOIR MAT -
CHAMPAGNE

NOIR MAT - ROSE

BLANC MAT

BLANC MAT -
CHAMPAGNE

BLANC MAT - ROSE



AUREA 3 TP

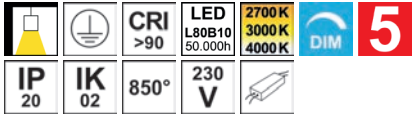

- Suspension décorative.
- Adaptateur pour Track III SURFACE.
- Livrée avec câble d'alimentation (réglable 2.00m max).
- Coloris 05 - 08 - 83 : câble noir.
- Coloris 30 - 49 - 82 : câble blanc.
- 2700K, 3000K ou 4000K au choix via un interrupteur à l'arrière du luminaire.
- Convertisseur dimmable intégré dans l'appareil.
- Compatible avec variateur début de phase.
- Réserver une phase spécifique du rail pour les produits dimmables.

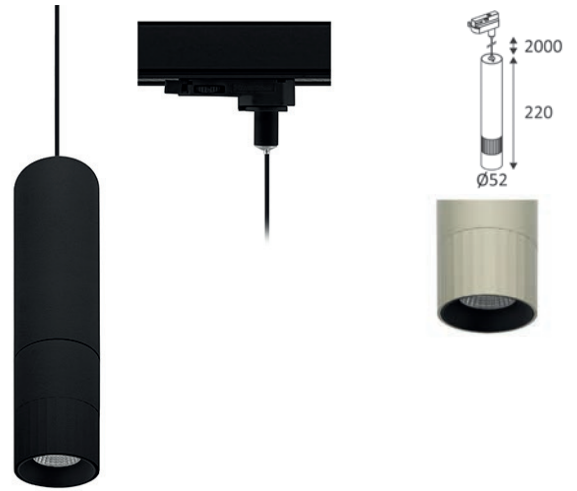

AUREA 3 TP	COULEUR	MATIÈRE	P	T°	LED LUMEN	SYSTEM LUMEN	α	€
TR43405	NOIR MAT	ALUMINIUM	6W	2700K 3000K 4000K	715Lm (4000K)	550Lm (4000K)	38°	117,00
TR43408	NOIR MAT - CHAMPAGNE	ALUMINIUM	6W	2700K 3000K 4000K	715Lm (4000K)	550Lm (4000K)	38°	128,00
TR43483	NOIR MAT - ROSE	ALUMINIUM	6W	2700K 3000K 4000K	715Lm (4000K)	550Lm (4000K)	38°	128,00
TR43430	BLANC MAT	ALUMINIUM	6W	2700K 3000K 4000K	715Lm (4000K)	550Lm (4000K)	38°	117,00
TR43449	BLANC MAT - CHAMPAGNE	ALUMINIUM	6W	2700K 3000K 4000K	715Lm (4000K)	550Lm (4000K)	38°	128,00
TR43482	BLANC MAT - ROSE	ALUMINIUM	6W	2700K 3000K 4000K	715Lm (4000K)	550Lm (4000K)	38°	128,00



HELLO 1 D

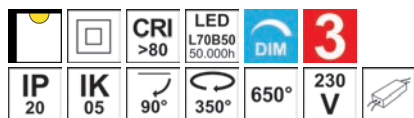

- Projecteur pour éclairage diffus.
- Adaptateur pour Track III SURFACE.
- Convertisseur dimmable intégré dans l'appareil.
- Compatible avec variateur fin de phase.
- Réserver une phase spécifique du rail pour les produits dimmables.

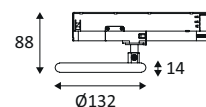

HELLO 1 D	COULEUR	MATIÈRE	P	T°	LED LUMEN	SYSTEM LUMEN	α	€
TR389WW05	■ NOIR MAT	ALUMINIUM	10W	3000K	1300Lm	825Lm	100°	134,00
TR389WW30	■ BLANC MAT	ALUMINIUM	10W	3000K	1300Lm	825Lm	100°	134,00



NOIR MAT

BLANC MAT

DANS LA MÊME GAMME



HELLO 1 P PAGE 224

HELLO 2 D

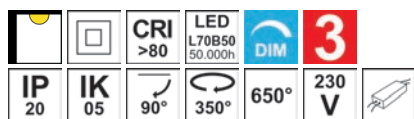

- Projecteur pour éclairage diffus.
- Adaptateur pour Track III SURFACE.
- Convertisseur dimmable intégré dans l'appareil.
- Compatible avec variateur fin de phase.
- Réserver une phase spécifique du rail pour les produits dimmables.

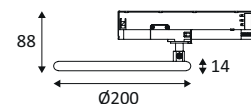

HELLO 2 D	COULEUR	MATIÈRE	P	T°	LED LUMEN	SYSTEM LUMEN	α	€
TR390WW05	■ NOIR MAT	ALUMINIUM	17W	3000K	2160Lm	1740Lm	100°	186,00
TR390WW30	■ BLANC MAT	ALUMINIUM	17W	3000K	2160Lm	1740Lm	100°	186,00



NOIR MAT

BLANC MAT

DANS LA MÊME GAMME



HELLO 2 P PAGE 224

HELLO 2 D



OSIS 2 PLUS





OSIS 1 PLUS

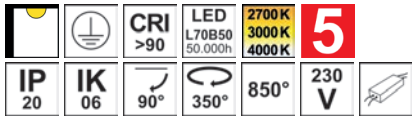

- Projecteur pour éclairage d'accentuation.
- Adaptateur pour Track III SURFACE.
- 2700K, 3000K ou 4000K au choix via un interrupteur sur l'adaptateur.
- Convertisseur non dimmable intégré dans l'appareil.

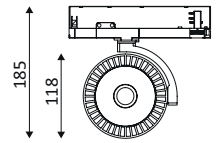

OSIS 1 PLUS	COULEUR	MATIÈRE	P	T°	LED LUMEN	SYSTEM LUMEN	α	€
TR43805	■ NOIR MAT	FONTE D'ALUMINIUM	25W	2700K 3000K 4000K	3200Lm (4000K)	2100Lm (4000K)	60°	86,00
TR43830	■ BLANC MAT	FONTE D'ALUMINIUM	25W	2700K 3000K 4000K	3200Lm (4000K)	2210Lm (4000K)	60°	86,00



NOIR MAT

BLANC MAT

OSIS 2 PLUS

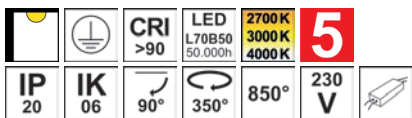

- Projecteur pour éclairage d'accentuation.
- Adaptateur pour Track III SURFACE.
- 2700K, 3000K ou 4000K au choix via un interrupteur sur l'adaptateur.
- Convertisseur non dimmable intégré dans l'appareil.

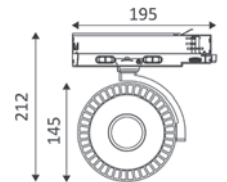

OSIS 2 PLUS	COULEUR	MATIÈRE	P	T°	LED LUMEN	SYSTEM LUMEN	α	€
TR43905	■ NOIR MAT	FONTE D'ALUMINIUM	40W	2700K 3000K 4000K	5250Lm (4000K)	3420Lm (4000K)	60°	103,00
TR43930	■ BLANC MAT	FONTE D'ALUMINIUM	40W	2700K 3000K 4000K	5250Lm (4000K)	4000Lm (4000K)	60°	103,00



NOIR MAT

BLANC MAT

TED

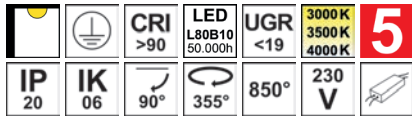

- Projecteur pour éclairage d'accentuation.
- Adaptateur pour Track III SURFACE.
- 3000K, 3500K ou 4000K au choix via un interrupteur à l'arrière du luminaire.
- Convertisseur non dimmable intégré dans l'appareil.

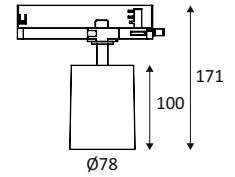

TED	COULEUR	MATIÈRE	P	T°	LED LUMEN	SYSTEM LUMEN	α	€
TR43505	NOIR MAT	ALUMINIUM	28W	3000K 3500K 4000K	3000Lm (4000K)	2140Lm (4000K)	45°	114,00
TR43530	BLANC MAT	ALUMINIUM	28W	3000K 3500K 4000K	3000Lm (4000K)	2140Lm (4000K)	45°	114,00



NOIR MAT



BLANC MAT





FOCAL

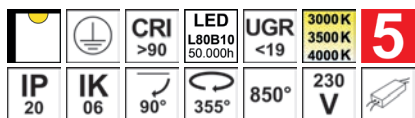

- Projecteur pour éclairage d'accentuation.
- Adaptateur pour Track III SURFACE.
- 3000K, 3500K ou 4000K au choix via un interrupteur à l'arrière du luminaire.
- Faisceau ajustable de 30° à 60°.
- Convertisseur non dimmable intégré dans l'appareil.

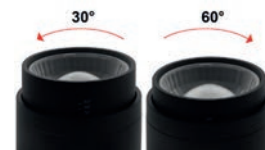
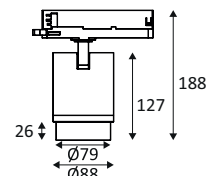

FOCAL	COULEUR	MATIÈRE	P	T°	LED LUMEN	SYSTEM LUMEN	α	€
TR43705	NOIR MAT	ALUMINIUM	32W	3000K 3500K 4000K	3550Lm (4000K)	2535Lm (4000K)	30-60°	136,00
TR43730	BLANC MAT	ALUMINIUM	32W	3000K 3500K 4000K	3550Lm (4000K)	2535Lm (4000K)	30-60°	136,00



NOIR MAT



BLANC MAT

FOCUS

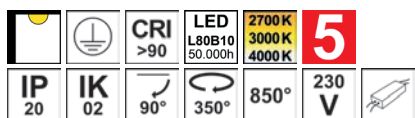

- Projecteur pour éclairage d'accentuation.
- Adaptateur pour Track III SURFACE.
- 2700K, 3000K ou 4000K au choix via un interrupteur à l'arrière du luminaire.
- Faisceau ajustable de 15° à 35° (TR393), ou de 35° à 60° (TR394).
- Convertisseur non dimmable intégré dans l'appareil.
- Base apparente TR241 à commander séparément.

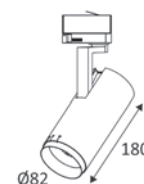

FOCUS	COULEUR	MATIÈRE	P	T°	LED LUMEN	SYSTEM LUMEN	α	€
TR39305	NOIR MAT	ALUMINIUM	35W	2700K 3000K 4000K	5400Lm (4000K)	4260Lm (4000K)	15-35°	197,00
TR39330	BLANC MAT	ALUMINIUM	35W	2700K 3000K 4000K	2815Lm (4000K)	2430Lm (4000K)	15-35°	197,00
TR39405	NOIR MAT	ALUMINIUM	35W	2700K 3000K 4000K	2815Lm (4000K)	2570Lm (4000K)	35-60°	197,00
TR39430	BLANC MAT	ALUMINIUM	35W	2700K 3000K 4000K	2815Lm (4000K)	2645Lm (4000K)	35-60°	197,00

ACCESSOIRES	COULEUR	DESCRIPTION	€
TR24130	NOIR	BASE APPARENTE	29,00
TR24131	BLANC	BASE APPARENTE	29,00



NOIR MAT



BLANC MAT

JACK 3 T

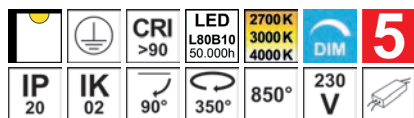

- Projecteur pour éclairage d'accentuation.
- Adaptateur pour Track III SURFACE.
- 2700K, 3000K ou 4000K au choix via un interrupteur à l'arrière du luminaire.
- Convertisseur dimmable intégré dans l'appareil.
- Compatible avec variateur fin de phase.
- Réserver une phase spécifique du rail pour les produits dimmables.
- Base apparente TR241 à commander séparément.

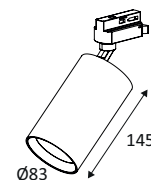

JACK 3 T	COULEUR	MATIÈRE	P	T°	LED LUMEN	SYSTEM LUMEN	α	€
TR42405	NOIR MAT	ALUMINIUM	30W	2700K 3000K 4000K	3310Lm (4000K)	2700Lm (4000K)	40°	207,00
TR42413	NOIR MAT - LAITON	ALUMINIUM	30W	2700K 3000K 4000K	3310Lm (4000K)	2700Lm (4000K)	40°	211,00
TR42406	NOIR MAT - OR ROSE	ALUMINIUM	30W	2700K 3000K 4000K	3310Lm (4000K)	2700Lm (4000K)	40°	235,00
TR42430	BLANC MAT	ALUMINIUM	30W	2700K 3000K 4000K	3310Lm (4000K)	2700Lm (4000K)	40°	207,00
TR42428	BLANC MAT - LAITON	ALUMINIUM	30W	2700K 3000K 4000K	3310Lm (4000K)	2700Lm (4000K)	40°	235,00
TR42402	BLANC MAT - OR ROSE	ALUMINIUM	30W	2700K 3000K 4000K	3310Lm (4000K)	2700Lm (4000K)	40°	235,00
TR42505	NOIR MAT	ALUMINIUM	30W	2700K 3000K 4000K	3310Lm (4000K)	2615Lm (4000K)	60°	207,00
TR42513	NOIR MAT - LAITON	ALUMINIUM	30W	2700K 3000K 4000K	3310Lm (4000K)	2615Lm (4000K)	60°	235,00
TR42506	NOIR MAT - OR ROSE	ALUMINIUM	30W	2700K 3000K 4000K	3310Lm (4000K)	2615Lm (4000K)	60°	235,00
TR42530	BLANC MAT	ALUMINIUM	30W	2700K 3000K 4000K	3310Lm (4000K)	2615Lm (4000K)	60°	207,00
TR42528	BLANC MAT - LAITON	ALUMINIUM	30W	2700K 3000K 4000K	3310Lm (4000K)	2615Lm (4000K)	60°	235,00
TR42502	BLANC MAT - OR ROSE	ALUMINIUM	30W	2700K 3000K 4000K	3310Lm (4000K)	2615Lm (4000K)	60°	235,00

ACCESSOIRES	COULEUR	DESCRIPTION	€
TR24130	NOIR	BASE APPARENTE	29,00
TR24131	BLANC	BASE APPARENTE	29,00



DANS LA MÊME GAMME



JACK 3 P PAGE 220



JACK 3 T



JACK 3 TP

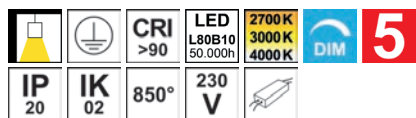

- Suspension décorative.
- Adaptateur pour Track III SURFACE.
- Livrée avec câble d'alimentation textile (réglable 1.60m max).
- Coloris 05 - 13 - 06 : câble noir.
- Coloris 30 - 28 - 02 : câble blanc.
- 2700K, 3000K ou 4000K au choix via un interrupteur à l'arrière du luminaire.
- Convertisseur dimmable intégré dans l'appareil.
- Compatible avec variateur fin de phase.
- Réserver une phase spécifique du rail pour les produits dimmables.

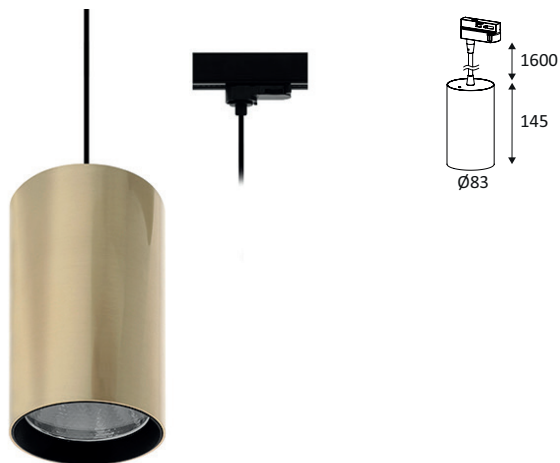

JACK 3 TP	COULEUR	MATIÈRE	P	T°	LED LUMEN	SYSTEM LUMEN	α	€
TR42605	NOIR MAT	ALUMINIUM	25W	2700K 3000K 4000K	2810Lm (4000K)	2270Lm (4000K)	60°	197,00
TR42613	NOIR MAT - LAITON	ALUMINIUM	25W	2700K 3000K 4000K	2810Lm (4000K)	2270Lm (4000K)	60°	230,00
TR42606	NOIR MAT - OR ROSE	ALUMINIUM	25W	2700K 3000K 4000K	2810Lm (4000K)	2270Lm (4000K)	60°	230,00
TR42630	BLANC MAT	ALUMINIUM	25W	2700K 3000K 4000K	2810Lm (4000K)	2270Lm (4000K)	60°	197,00
TR42628	BLANC MAT - LAITON	ALUMINIUM	25W	2700K 3000K 4000K	2810Lm (4000K)	2270Lm (4000K)	60°	230,00
TR42602	BLANC MAT - OR ROSE	ALUMINIUM	25W	2700K 3000K 4000K	2810Lm (4000K)	2270Lm (4000K)	60°	230,00



DANS LA MÊME GAMME



JACK 3 P PAGE 220



JACK 3 TP





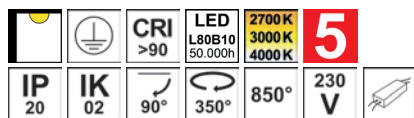





LIMA 1 PLUS



- Projecteur pour éclairage d'accentuation.
- Adaptateur pour Track III SURFACE.
- 2700K, 3000K ou 4000K au choix via un interrupteur à l'arrière du luminaire.
- Convertisseur non dimmable intégré dans l'appareil.
- Utiliser les verres pour alimentation avec la température de couleur 3000K.
- Base apparente TR241 à commander séparément.



LIMA 1 PLUS	COULEUR	MATIÈRE	P	T°	LED LUMEN	SYSTEM LUMEN	α	€
TR39505	■ NOIR MAT	ALUMINIUM	25W	2700K 3000K 4000K	3000Lm (4000K)	2645Lm (4000K)	40°	153,00
TR39530	■ BLANC MAT	ALUMINIUM	25W	2700K 3000K 4000K	3000Lm (4000K)	2865Lm (4000K)	40°	153,00
TR39605	■ NOIR MAT	ALUMINIUM	25W	2700K 3000K 4000K	3000Lm (4000K)	2655Lm (4000K)	60°	153,00
TR39630	■ BLANC MAT	ALUMINIUM	25W	2700K 3000K 4000K	3000Lm (4000K)	2855Lm (4000K)	60°	153,00
ACCESSOIRES	COULEUR	DESCRIPTION						€
TR32105	NOIR	GRILLE NID D'ABEILLE DIA.71MM						5,00
TR32432		VERRE ALIMENTATION DIA.71MM						27,00
TR32756		VERRE ALIMENTATION DIA.71MM						27,00
TR33058		FILTRE LAME DE LUMIERE DIA.71MM						4,00
TR38505	NOIR MAT	VOLET COUPE FLUX DIA.71MM						19,00
TR38530	BLANC MAT	VOLET COUPE FLUX DIA.71MM						19,00
TR24130	NOIR	BASE APPARENTE						29,00
TR24131	BLANC	BASE APPARENTE						29,00



NOIR MAT







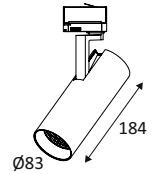
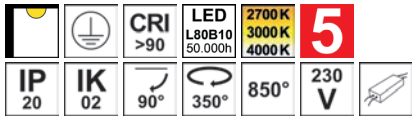

BLANC MAT



LIMA 2 PLUS



- Projecteur pour éclairage d'accentuation.
- Adaptateur pour Track III SURFACE.
- 2700K, 3000K ou 4000K au choix via un interrupteur à l'arrière du luminaire.
- Convertisseur non dimmable intégré dans l'appareil.
- Utiliser les verres pour alimentation avec la température de couleur 3000K.
- Base apparente TR241 à commander séparément.

LIMA 2 PLUS	COULEUR	MATIÈRE	P	T°	LED LUMEN	SYSTEM LUMEN	α	€
TR39705	NOIR MAT	ALUMINIUM	35W	2700K 3000K 4000K	4500Lm (4000K)	3485Lm (4000K)	40°	173,00
TR39730	BLANC MAT	ALUMINIUM	35W	2700K 3000K 4000K	4500Lm (4000K)	4045Lm (4000K)	40°	173,00
TR39805	NOIR MAT	ALUMINIUM	35W	2700K 3000K 4000K	4500Lm (4000K)	3550Lm (4000K)	60°	173,00
TR39830	BLANC MAT	ALUMINIUM	35W	2700K 3000K 4000K	4500Lm (4000K)	4050Lm (4000K)	60°	173,00
ACCESSOIRES	COULEUR	DESCRIPTION						€
TR32205	NOIR	GRILLE NID D'ABEILLE DIA.83MM						6,00
TR32532		VERRE ALIMENTATION DIA.83MM						28,00
TR32856		VERRE ALIMENTATION DIA.83MM						28,00
TR33158		FILTRE LAME DE LUMIERE DIA.83MM						4,00
TR38605	NOIR MAT	VOLET COUPE FLUX DIA.83MM						21,00
TR38630	BLANC MAT	VOLET COUPE FLUX DIA.83MM						21,00
TR24130	NOIR	BASE APPARENTE						29,00
TR24131	BLANC	BASE APPARENTE						29,00



NOIR MAT







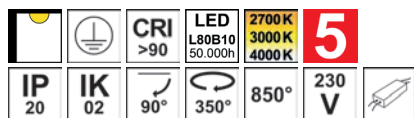

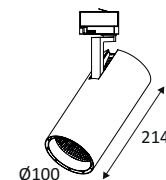

BLANC MAT

LIMA 3 PLUS



- Projecteur pour éclairage d'accentuation.
- Adaptateur pour Track III SURFACE.
- 2700K, 3000K ou 4000K au choix via un interrupteur à l'arrière du luminaire.
- Convertisseur non dimmable intégré dans l'appareil.
- Utiliser les verres pour alimentation avec la température de couleur 3000K.
- Base apparente TR241 à commander séparément.



LIMA 3 PLUS	COULEUR	MATIÈRE	P	T°	LED LUMEN	SYSTEM LUMEN	α	€
TR39905	■ NOIR MAT	ALUMINIUM	50W	2700K 3000K 4000K	5600Lm (4000K)	4165Lm (4000K)	40°	213,00
TR39930	■ BLANC MAT	ALUMINIUM	50W	2700K 3000K 4000K	5600Lm (4000K)	4580Lm (4000K)	40°	213,00
TR40005	■ NOIR MAT	ALUMINIUM	50W	2700K 3000K 4000K	5600Lm (4000K)	4110Lm (4000K)	60°	213,00
TR40030	■ BLANC MAT	ALUMINIUM	50W	2700K 3000K 4000K	5600Lm (4000K)	4440Lm (4000K)	60°	213,00
ACCESSOIRES	COULEUR	DESCRIPTION						€
TR32305	NOIR	GRILLE NID D'ABEILLE DIA.100MM						7,00
TR32632		VERRE ALIMENTATION DIA.100MM						31,00
TR32956		VERRE ALIMENTATION DIA.100MM						31,00
TR33258		FILTRE LAME DE LUMIERE DIA.100MM						5,00
TR38705	NOIR MAT	VOLET COUPE FLUX DIA.100MM						24,00
TR38730	BLANC MAT	VOLET COUPE FLUX DIA.100MM						24,00
TR24130	NOIR	BASE APPARENTE						29,00
TR24131	BLANC	BASE APPARENTE						29,00



NOIR MAT



BLANC MAT



LIMA 3 PLUS



LINEA 1

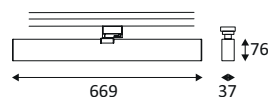

- Structure linéaire pour éclairage diffus.
- Adaptateur pour Track III SURFACE.
- Convertisseur non dimmable intégré dans l'appareil.
- Grille nid d'abeille en option.

LINEA 1	COULEUR	MATIÈRE	P	T°	L(MM)	LED LUMEN	SYSTEM LUMEN	α	€
TR357WW05	NOIR	ALUMINIUM	30W	3000K	669	3750Lm	3190Lm	120°	211,00
TR357WW30	BLANC	ALUMINIUM	30W	3000K	669	3750Lm	3190Lm	120°	211,00
TR357NW05	NOIR	ALUMINIUM	30W	4000K	669	3900Lm	3270Lm	120°	211,00
TR357NW30	BLANC	ALUMINIUM	30W	4000K	669	3900Lm	3270Lm	120°	211,00

ACCESSOIRES	COULEUR	DESCRIPTION	€
TR38805	NOIR	GRILLE NID D'ABEILLE 665X35MM	5,00



NOIR



BLANC

LINEA 2



- Structure linéaire pour éclairage diffus.
- Adaptateur pour Track III SURFACE.
- Convertisseur non dimmable intégré dans l'appareil.
- Grilles nid d'abeille en option.

LINEA 2	COULEUR	MATIÈRE	P	T°	L(MM)	LED LUMEN	SYSTEM LUMEN	α	€
TR358WW05	NOIR	ALUMINIUM	60W	3000K	669	2x3750Lm	6375Lm	120°	318,00
TR358WW30	BLANC	ALUMINIUM	60W	3000K	669	2x3750Lm	6375Lm	120°	318,00
TR358NW05	NOIR	ALUMINIUM	60W	4000K	669	2x3900Lm	6540Lm	120°	318,00
TR358NW30	BLANC	ALUMINIUM	60W	4000K	669	2x3900Lm	6540Lm	120°	318,00

ACCESSOIRES	COULEUR	DESCRIPTION	L(MM)	€
TR38805	NOIR	GRILLE NID D'ABEILLE 665X35MM	665	5,00



NOIR



BLANC

LINEA 1



LINEA 2

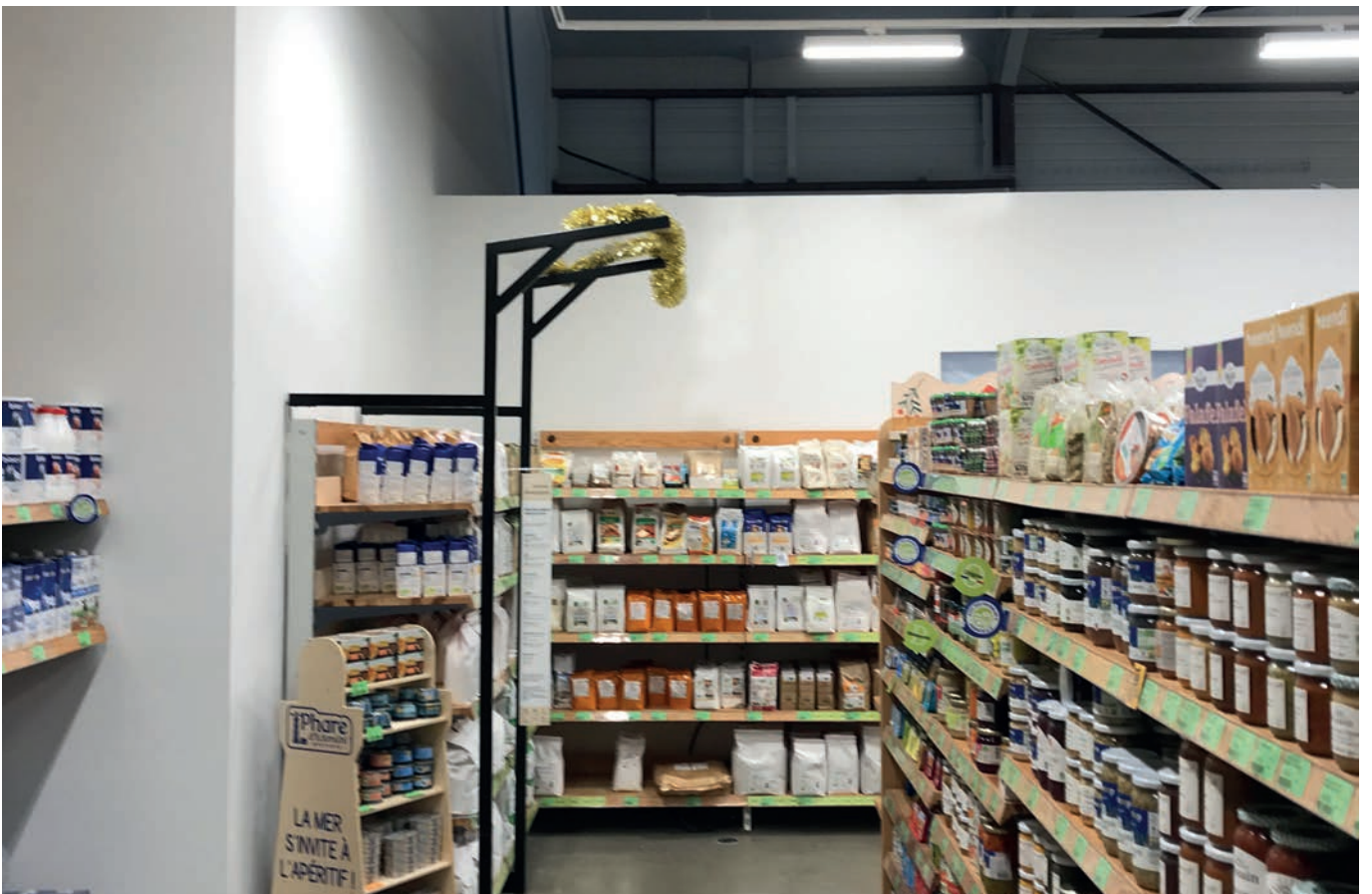

INDIGO

LIGHTING



RAILS & PROJECTEURS TRACK 48VDC









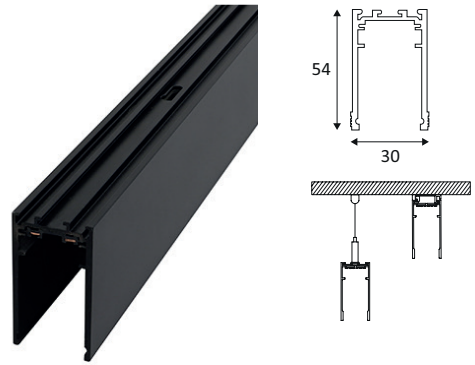







TRACK 48VDC SURFACE



- Rail apparent 48Vdc.
- Convertisseur à commander séparément.
- Le convertisseur peut être déporté ou inclus dans le rail en utilisant un boîtier prévu à cet effet (TR25005 + CD144 ou TR37505).
- Max. 20m et 400W en ligne continue.



TRACK 48VDC SURFACE	COULEUR	MATIÈRE	L(MM)	€	
TR24005	■	NOIR MAT	ALUMINIUM	1000	72,00
TR24105	■	NOIR MAT	ALUMINIUM	2000	143,00
TR24205	■	NOIR MAT	ALUMINIUM	3000	214,00
ACCESSOIRES	COULEUR	DESCRIPTION	L(MM)	€	
ALIMENTATIONS					
TR24605	NOIR MAT	ALIMENTATION + CABLE 150CM	75	 38,00	
CONNECTEURS					
TR24805	NOIR MAT	CONNEXION MECANIQUE	24	 7,00	
TR24705	NOIR MAT	CONNEXION ELECTRIQUE	75	 14,00	
TR24305	NOIR MAT	CONNEXION L 90° PLAFOND AVEC TR24805	74	 15,00	
TR24405	NOIR MAT	CONNEXION L 90° MUR INT AVEC TR24805	99	 17,00	
TR24505	NOIR MAT	CONNEXION L 90° MUR EXT AVEC TR24805	99	 15,00	
TR24905	NOIR MAT	CONNEXION ELEC + CABLE POUR TR243/244/245 TR263/264/265	75	 37,00	
TR36505	NOIR MAT	CONNEXION ELEC L 90° INTERIEUR PLAFOND	74	 35,00	
TR36605	NOIR MAT	CONNEXION ELEC T GAUCHE PLAFOND	110	 44,00	
TR36705	NOIR MAT	CONNEXION ELEC T DROITE PLAFOND	110	 44,00	
TR36805	NOIR MAT	CONNEXION ELEC X PLAFOND	110	 46,00	
TR37205	NOIR MAT	CONNEXION ELEC DOUBLE 120° PLAFOND	110	 38,00	
TR37305	NOIR MAT	CONNEXION ELEC TRIPLE 120° PLAFOND	128	 42,00	
TR37405	NOIR MAT	CONNEXION MECANIQUE MULTIPLE PLAFOND	134	 159,00	



CONVERTISSEURS					
TR25005	NOIR MAT	BOITIER + CABLE 150CM POUR DRIVER 90W	280		86,00
CD144		CONVERTISSEUR 90W 48V	205		149,00
CD145		CONVERTISSEUR 180W 48V	244		173,00
CD146		CONVERTISSEUR 400W 48V	240		374,00
TR37505	NOIR MAT	CONVERTISSEUR 225W 48V AVEC BOITIER	543		450,00
CONVERTISSEURS DIMMABLES					
CD166		CONVERTISSEUR 135W 48V DALI-PUSH	235		448,00
ACCESSOIRES DE FIXATION					
TR25105	NOIR MAT	FILIN DE SUSPENSION 150CM	1500		15,00
MOULURES					
TR25205	NOIR MAT	MOULURE DE FINITION 100CM	1000		7,00
TR25305	NOIR MAT	MOULURE DE FINITION 200CM	2000		10,00
TR25405	NOIR MAT	MOULURE DE FINITION 300CM	3000		13,00
EMBOUS					
TR25505	NOIR MAT	EMBOUT DE FINITION	54		5,00

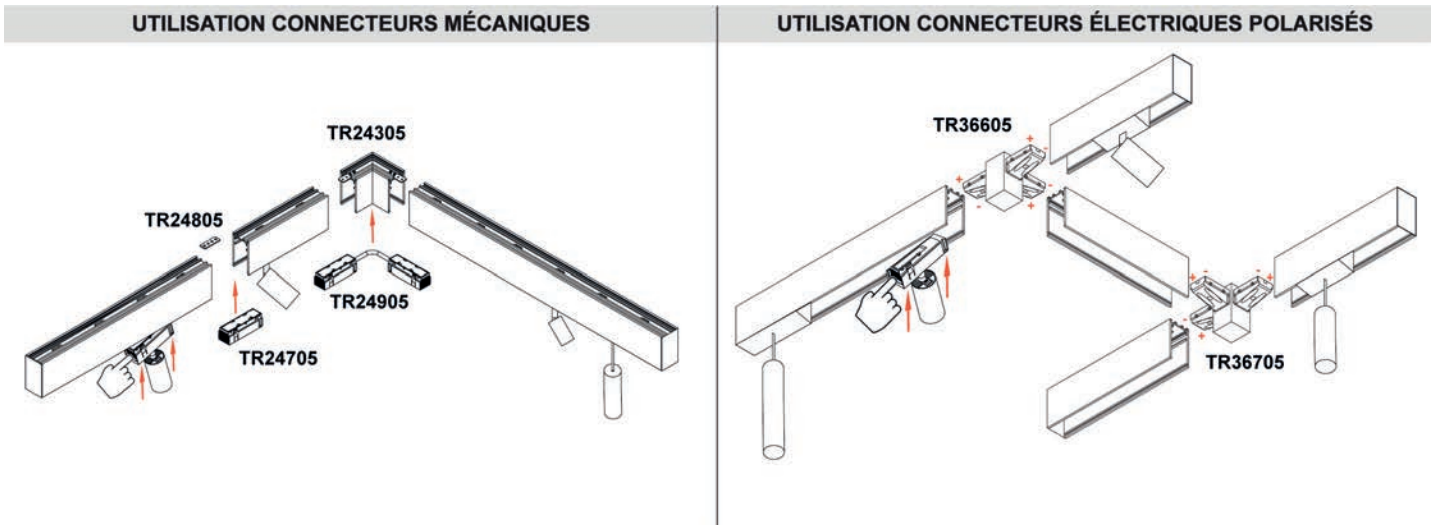

TRACK 48VDC RECESSED

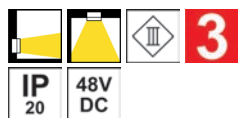

- Rail encastré 48Vdc.
- Enduit de finition à réaliser.
- Convertisseur à commander séparément.
- Le convertisseur peut être déporté ou inclus dans le rail en utilisant un boîtier prévu à cet effet (TR25005 + CD144 ou TR37505).
- Max. 20m et 400W en ligne continue.

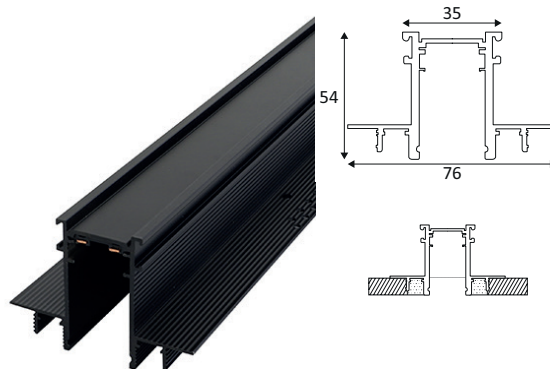

TRACK 48VDC RECESSED	COULEUR	MATIÈRE	L(MM)	€	
TR26005		NOIR MAT	ALUMINIUM	1000	83,00
TR26105		NOIR MAT	ALUMINIUM	2000	166,00
TR26205		NOIR MAT	ALUMINIUM	3000	248,00
ACCESSOIRES	COULEUR	DESCRIPTION		€	
ALIMENTATIONS					
TR24605	NOIR MAT	ALIMENTATION + CABLE 150CM		38,00	
CONNECTEURS					
TR24805	NOIR MAT	CONNEXION MECANIQUE		7,00	
TR24705	NOIR MAT	CONNEXION ELECTRIQUE		14,00	
TR26305	NOIR MAT	CONNEXION L 90° PLAFOND AVEC TR24805		17,00	
TR26405	NOIR MAT	CONNEXION L 90° MUR INT AVEC TR24805		17,00	
TR26505	NOIR MAT	CONNEXION L 90° MUR EXT AVEC TR24805		17,00	
TR24905	NOIR MAT	CONNEXION ELEC + CABLE POUR TR243/244/245 TR263/264/265		37,00	
CONVERTISSEURS					
TR25005	NOIR MAT	BOITIER + CABLE 150CM POUR DRIVER 90W		86,00	
CD144		CONVERTISSEUR 90W 48V		149,00	
CD145		CONVERTISSEUR 180W 48V		173,00	
CD146		CONVERTISSEUR 400W 48V		374,00	
TR37505	NOIR MAT	CONVERTISSEUR 225W 48V AVEC BOITIER		450,00	
CONVERTISSEURS DIMMABLES					
CD166		CONVERTISSEUR 135W 48V DALI-PUSH		448,00	
EMBOUTS					
TR25505	NOIR MAT	EMBOUT DE FINITION		5,00	

UTILISATION CONNECTEURS MÉCANIQUES

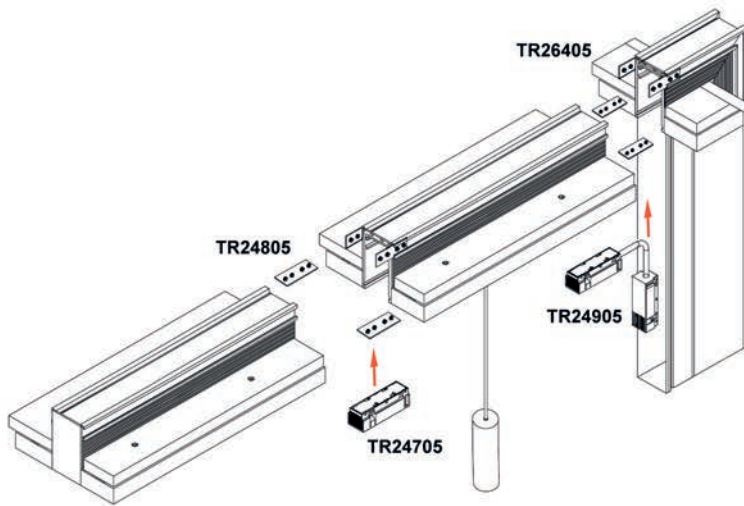

INSTALLATION AVANT LE MONTAGE DU FAUX PLAFOND

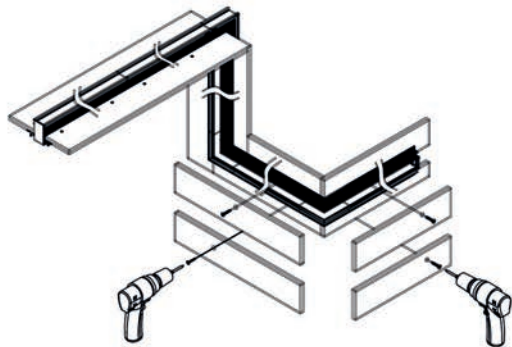

INSTALLATION FAUX PLAFOND EXISTANT

(uniquement en ligne continue)



KARO 1

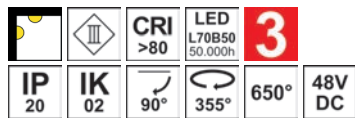

- Luminaire pour éclairage d'accentuation pour TRACK 48VDC SURFACE et RECESSED.
- Non dimmable.

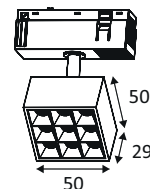

KARO 1	COULEUR	MATIÈRE	P	T°	L(MM)	LED LUMEN	SYSTEM LUMEN	α	€
NON DIMMABLE									
TR360WW05	■ NOIR MAT	ALUMINIUM	7W	3000K	50	1150Lm	525Lm	30°	78,00
TR360NW05	■ NOIR MAT	ALUMINIUM	7W	4000K	50	1250Lm	530Lm	30°	78,00

KARO 2

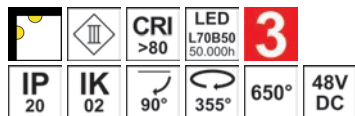

- Luminaire pour éclairage d'accentuation pour TRACK 48VDC SURFACE et RECESSED.
- Non dimmable.

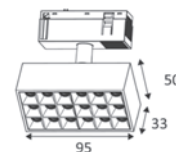

KARO 2	COULEUR	MATIÈRE	P	T°	L(MM)	LED LUMEN	SYSTEM LUMEN	α	€
NON DIMMABLE									
TR361WW05	■ NOIR MAT	ALUMINIUM	15W	3000K	95	1750Lm	1140Lm	30°	105,00
TR361NW05	■ NOIR MAT	ALUMINIUM	15W	4000K	95	1850Lm	1145Lm	30°	105,00



KARO 3

- Luminaire pour éclairage d'accentuation pour TRACK 48VDC SURFACE et RECESSED.
- Non dimmable.

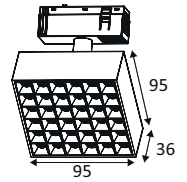

KARO 3	COULEUR	MATIÈRE	P	T°	L(MM)	LED LUMEN	SYSTEM LUMEN	α	€
NON DIMMABLE									
TR362WW05	■ NOIR MAT	ALUMINIUM	25W	3000K	95	3000Lm	2115Lm	30°	130,00
TR362NW05	■ NOIR MAT	ALUMINIUM	25W	4000K	95	3100Lm	2220Lm	30°	130,00



LOOP 1





LOOP 1

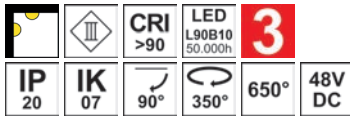

- Projecteur pour éclairage d'accentuation pour TRACK 48VDC SURFACE et RECESSED.
- Non dimmable.

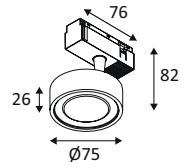

LOOP 1	COULEUR	MATIÈRE	P	T°	L(MM)	LED LUMEN	SYSTEM LUMEN	α	€
NON DIMMABLE									
TR391WW05	■ NOIR MAT	ALUMINIUM	10W	3000K	76	630Lm	555Lm	38°	105,00

LOOP 2

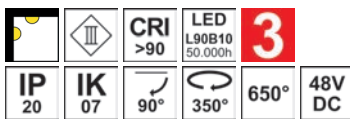

- Projecteur pour éclairage d'accentuation pour TRACK 48VDC SURFACE et RECESSED.
- Non dimmable.

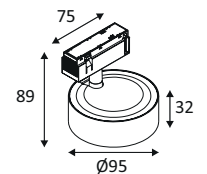

LOOP 2	COULEUR	MATIÈRE	P	T°	L(MM)	LED LUMEN	SYSTEM LUMEN	α	€
NON DIMMABLE									
TR392WW05	■ NOIR MAT	ALUMINIUM	13W	3000K	76	1430Lm	1220Lm	38°	111,00
TR392WW13	■ NOIR MAT - LAITON MAT	ALUMINIUM	13W	3000K	76	1430Lm	1220Lm	38°	114,00
TR392WW14	■ NOIR MAT - CUIVRE MAT	ALUMINIUM	13W	3000K	76	1430Lm	1220Lm	38°	114,00



NOIR MAT

NOIR MAT - LAITON MAT

NOIR MAT - CUIVRE MAT

PARO 1

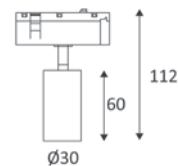
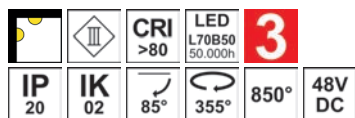

- Projecteur pour éclairage d'accentuation pour TRACK 48VDC SURFACE et RECESSED.

PARO 1	COULEUR	MATIÈRE	P	T°	LED LUMEN	SYSTEM LUMEN	α	€
NON DIMMABLE								
TR286SW05	■ NOIR MAT	ALUMINIUM	8W	2700K	640Lm	420Lm	24°	55,00
TR286WW05	■ NOIR MAT	ALUMINIUM	8W	3000K	660Lm	465Lm	24°	58,00
TR286NW05	■ NOIR MAT	ALUMINIUM	8W	4000K	690Lm	525Lm	24°	58,00
TR285SW05	■ NOIR MAT	ALUMINIUM	8W	2700K	640Lm	510Lm	36°	74,00
TR285WW05	■ NOIR MAT	ALUMINIUM	8W	3000K	660Lm	520Lm	36°	74,00
TR285NW05	■ NOIR MAT	ALUMINIUM	8W	4000K	690Lm	535Lm	36°	74,00
TR284SW05	■ NOIR MAT	ALUMINIUM	8W	2700K	640Lm	465Lm	50°	55,00
TR284WW05	■ NOIR MAT	ALUMINIUM	8W	3000K	660Lm	470Lm	50°	58,00
TR284NW05	■ NOIR MAT	ALUMINIUM	8W	4000K	690Lm	475Lm	50°	58,00
DIMMABLE DALI								
TR286WW05DA	■ NOIR MAT	ALUMINIUM	8W	3000K	660Lm	465Lm	24°	184,00
TR286NW05DA	■ NOIR MAT	ALUMINIUM	8W	4000K	690Lm	525Lm	24°	194,00
TR285WW05DA	■ NOIR MAT	ALUMINIUM	8W	3000K	660Lm	520Lm	36°	182,00
TR285NW05DA	■ NOIR MAT	ALUMINIUM	8W	4000K	690Lm	535Lm	36°	182,00
TR284WW05DA	■ NOIR MAT	ALUMINIUM	8W	3000K	660Lm	470Lm	50°	184,00
TR284NW05DA	■ NOIR MAT	ALUMINIUM	8W	4000K	690Lm	475Lm	50°	184,00





PARO 2

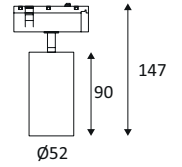
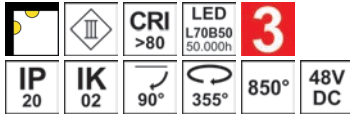

- Projecteur pour éclairage d'accentuation pour TRACK 48VDC SURFACE et RECESSED.





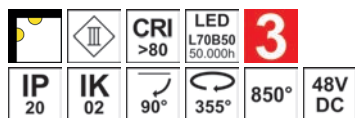

PARO 2	COULEUR	MATIÈRE	P	T°	LED LUMEN	SYSTEM LUMEN	α	€
NON DIMMABLE								
TR289SW05	■ NOIR MAT	ALUMINIUM	14W	2700K	1250Lm	945Lm	15°	86,00
TR289WW05	■ NOIR MAT	ALUMINIUM	14W	3000K	1380Lm	1015Lm	15°	90,00
TR289NW05	■ NOIR MAT	ALUMINIUM	14W	4000K	1500Lm	1090Lm	15°	90,00
TR288SW05	■ NOIR MAT	ALUMINIUM	14W	2700K	1250Lm	985Lm	30°	115,00
TR288WW05	■ NOIR MAT	ALUMINIUM	14W	3000K	1380Lm	1055Lm	30°	115,00
TR288NW05	■ NOIR MAT	ALUMINIUM	14W	4000K	1500Lm	1120Lm	30°	115,00
TR287SW05	■ NOIR MAT	ALUMINIUM	14W	2700K	1250Lm	975Lm	50°	86,00
TR287WW05	■ NOIR MAT	ALUMINIUM	14W	3000K	1380Lm	1150Lm	50°	98,00
TR287NW05	■ NOIR MAT	ALUMINIUM	14W	4000K	1500Lm	1200Lm	50°	90,00
DIMMABLE DALI								
TR289WW05DA	■ NOIR MAT	ALUMINIUM	14W	3000K	1380Lm	1015Lm	15°	220,00
TR289NW05DA	■ NOIR MAT	ALUMINIUM	14W	4000K	1500Lm	1090Lm	15°	232,00
TR288WW05DA	■ NOIR MAT	ALUMINIUM	14W	3000K	1380Lm	1055Lm	30°	214,00
TR288NW05DA	■ NOIR MAT	ALUMINIUM	14W	4000K	1500Lm	1120Lm	30°	214,00
TR287WW05DA	■ NOIR MAT	ALUMINIUM	14W	3000K	1380Lm	1150Lm	50°	220,00
TR287NW05DA	■ NOIR MAT	ALUMINIUM	14W	4000K	1500Lm	1200Lm	50°	220,00
ACCESSOIRES	COULEUR	DESCRIPTION						€
TR29005	NOIR	BAGUE CYLINDRIQUE						17,00
TR29105	NOIR	BAGUE WALL WASHER						26,00
TR29337		BAGUE OPALINE						7,00
TR29437		DIFFUSEUR OPALIN						3,00
TR29537		FILTRE LAME DE LUMIERE						3,00
TR29605	NOIR	GRILLE NID D'ABEILLE						3,00

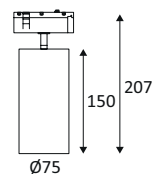
PARO 3



- Projecteur pour éclairage d'accentuation pour TRACK 48VDC SURFACE et RECESSED.



PARO 3	COULEUR	MATIÈRE	P	T°	LED LUMEN	SYSTEM LUMEN	α	€
NON DIMMABLE								
TR300WW05	■ NOIR MAT	ALUMINIUM	35W	3000K	3820Lm	2840Lm	30°	198,00
TR300NW05	■ NOIR MAT	ALUMINIUM	35W	4000K	4200Lm	3100Lm	30°	198,00
TR299WW05	■ NOIR MAT	ALUMINIUM	35W	3000K	3820Lm	2930Lm	50°	157,00
TR299NW05	■ NOIR MAT	ALUMINIUM	35W	4000K	4200Lm	3215Lm	50°	157,00
DIMMABLE DALI								
TR300WW05DA	■ NOIR MAT	ALUMINIUM	28W	3000K	3400Lm	2525Lm	30°	281,00
TR300NW05DA	■ NOIR MAT	ALUMINIUM	28W	4000K	3700Lm	2870Lm	30°	281,00
TR299WW05DA	■ NOIR MAT	ALUMINIUM	28W	3000K	3400Lm	2540Lm	50°	293,00
TR299NW05DA	■ NOIR MAT	ALUMINIUM	28W	4000K	3700Lm	2925Lm	50°	293,00
ACCESSOIRES	COULEUR	DESCRIPTION						€
TR30105	NOIR	BAGUE CYLINDRIQUE						30,00
TR30205	NOIR	BAGUE WALL WASHER						43,00
TR30337		BAGUE OPALINE						13,00
TR30437		DIFFUSEUR OPALIN						4,00
TR30537		FILTRE LAME DE LUMIERE						4,00
TR30605	NOIR	GRILLE NID D'ABEILLE						6,00



PARO 3



VIGO

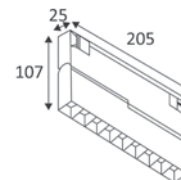
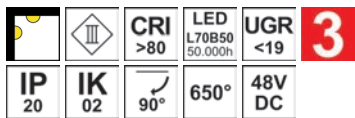

- Luminaire pour éclairage d'accentuation pour TRACK 48VDC SURFACE et RECESSED.
- Réflecteur basse luminance.

VIGO	COULEUR	MATIÈRE	P	T°	L(MM)	LED LUMEN	SYSTEM LUMEN	α	€
NON DIMMABLE									
TR272WW05	■ NOIR MAT	ALUMINIUM	12W	3000K	205	1030Lm	890Lm	12°	219,00
TR272NW05	■ NOIR MAT	ALUMINIUM	12W	4000K	205	1270Lm	1015Lm	12°	219,00
TR271WW05	■ NOIR MAT	ALUMINIUM	12W	3000K	205	1030Lm	915Lm	24°	219,00
TR271NW05	■ NOIR MAT	ALUMINIUM	12W	4000K	205	1270Lm	995Lm	24°	219,00
TR270WW05	■ NOIR MAT	ALUMINIUM	12W	3000K	205	1030Lm	940Lm	36°	219,00
TR270NW05	■ NOIR MAT	ALUMINIUM	12W	4000K	205	1270Lm	985Lm	36°	219,00
DIMMABLE DALI									
TR272WW05DA	■ NOIR MAT	ALUMINIUM	12W	3000K	205	1030Lm	890Lm	12°	293,00
TR272NW05DA	■ NOIR MAT	ALUMINIUM	12W	4000K	205	1270Lm	1015Lm	12°	309,00
TR271WW05DA	■ NOIR MAT	ALUMINIUM	12W	3000K	205	1030Lm	915Lm	24°	293,00
TR271NW05DA	■ NOIR MAT	ALUMINIUM	12W	4000K	205	1270Lm	995Lm	24°	293,00
TR270WW05DA	■ NOIR MAT	ALUMINIUM	12W	3000K	205	1030Lm	940Lm	36°	293,00
TR270NW05DA	■ NOIR MAT	ALUMINIUM	12W	4000K	205	1270Lm	985Lm	36°	293,00





ONEX

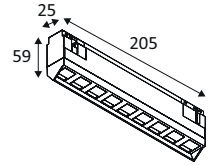
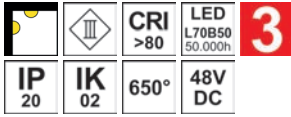

- Luminaire pour éclairage d'accentuation pour TRACK 48VDC SURFACE et RECESSED.
- Wall washer.

ONEX	COULEUR	MATIÈRE	P	T°	L(MM)	LED LUMEN	SYSTEM LUMEN	€
NON DIMMABLE								
TR283WW05	■ NOIR MAT	ALUMINIUM	12W	3000K	205	1030Lm	525Lm	173,00
TR283NW05	■ NOIR MAT	ALUMINIUM	12W	4000K	205	1270Lm	595Lm	173,00
DIMMABLE DALI								
TR283WW05DA	■ NOIR MAT	ALUMINIUM	12W	3000K	205	1030Lm	525Lm	262,00
TR283NW05DA	■ NOIR MAT	ALUMINIUM	12W	4000K	205	1270Lm	595Lm	262,00

CADIX

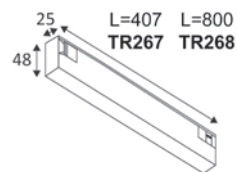
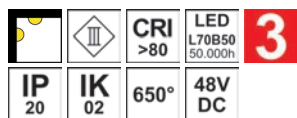

- Structure linéaire pour TRACK 48VDC SURFACE et RECESSED.



CADIX	COULEUR	MATIÈRE	P	T°	L(MM)	LED LUMEN	SYSTEM LUMEN	α	€
NON DIMMABLE									
TR267SW05	■ NOIR MAT	ALUMINIUM	11W	2700K	407	1280Lm	775Lm	110°	116,00
TR267WW05	■ NOIR MAT	ALUMINIUM	11W	3000K	407	1325Lm	785Lm	110°	116,00
TR267NW05	■ NOIR MAT	ALUMINIUM	11W	4000K	407	1440Lm	990Lm	110°	116,00
TR268WW05	■ NOIR MAT	ALUMINIUM	18W	3000K	800	2305Lm	1470Lm	110°	201,00
TR268NW05	■ NOIR MAT	ALUMINIUM	18W	4000K	800	2495Lm	1485Lm	110°	201,00
DIMMABLE DALI									
TR267WW05DA	■ NOIR MAT	ALUMINIUM	11W	3000K	407	1325Lm	785Lm	110°	215,00
TR267NW05DA	■ NOIR MAT	ALUMINIUM	11W	4000K	407	1440Lm	990Lm	110°	215,00
TR268WW05DA	■ NOIR MAT	ALUMINIUM	18W	3000K	800	2305Lm	1470Lm	110°	285,00
TR268NW05DA	■ NOIR MAT	ALUMINIUM	18W	4000K	800	2495Lm	1485Lm	110°	285,00





BERN

		CRI >80	LED L70B50 50.000h	UGR <19	3
IP 20	IK 02	650°	48V DC		

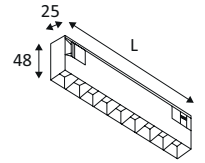

- Structure linéaire pour éclairage d'accentuation pour TRACK 48VDC SURFACE et RECESSED.
- Réflecteur basse luminance.



BERN	COULEUR	MATIÈRE	P	T°	L(MM)	LED LUMEN	SYSTEM LUMEN	α	€
NON DIMMABLE									
TR281SW05	■ NOIR MAT	ALUMINIUM	12W	2700K	205	1000Lm	800Lm	12°	143,00
TR281WW05	■ NOIR MAT	ALUMINIUM	12W	3000K	205	1030Lm	830Lm	12°	151,00
TR281NW05	■ NOIR MAT	ALUMINIUM	12W	4000K	205	1270Lm	880Lm	12°	151,00
TR280SW05	■ NOIR MAT	ALUMINIUM	12W	2700K	205	1000Lm	830Lm	24°	143,00
TR280WW05	■ NOIR MAT	ALUMINIUM	12W	3000K	205	1030Lm	865Lm	24°	151,00
TR280NW05	■ NOIR MAT	ALUMINIUM	12W	4000K	205	1270Lm	940Lm	24°	151,00
TR279SW05	■ NOIR MAT	ALUMINIUM	12W	2700K	205	1000Lm	815Lm	36°	151,00
TR279WW05	■ NOIR MAT	ALUMINIUM	12W	3000K	205	1030Lm	850Lm	36°	151,00
TR279NW05	■ NOIR MAT	ALUMINIUM	12W	4000K	205	1270Lm	940Lm	36°	151,00
TR378WW05	■ NOIR MAT	ALUMINIUM	21W	3000K	407	1850Lm	1475Lm	12°	273,00
TR379WW05	■ NOIR MAT	ALUMINIUM	21W	3000K	407	1850Lm	1510Lm	24°	273,00
TR380WW05	■ NOIR MAT	ALUMINIUM	21W	3000K	407	1850Lm	1510Lm	36°	273,00
TR381WW05	■ NOIR MAT	ALUMINIUM	39W	3000K	812	3710Lm	3005Lm	12°	475,00
TR382WW05	■ NOIR MAT	ALUMINIUM	39W	3000K	812	3710Lm	3020Lm	24°	475,00
TR383WW05	■ NOIR MAT	ALUMINIUM	39W	3000K	812	3710Lm	3040Lm	36°	475,00
DIMMABLE DALI									
TR281WW05DA	■ NOIR MAT	ALUMINIUM	12W	3000K	205	1030Lm	830Lm	12°	244,00
TR281NW05DA	■ NOIR MAT	ALUMINIUM	12W	4000K	205	1270Lm	880Lm	12°	257,00
TR280WW05DA	■ NOIR MAT	ALUMINIUM	12W	3000K	205	1030Lm	865Lm	24°	244,00
TR280NW05DA	■ NOIR MAT	ALUMINIUM	12W	4000K	205	1270Lm	940Lm	24°	244,00
TR279WW05DA	■ NOIR MAT	ALUMINIUM	12W	3000K	205	1030Lm	850Lm	36°	244,00
TR279NW05DA	■ NOIR MAT	ALUMINIUM	12W	4000K	205	1270Lm	940Lm	36°	244,00
TR378WW05DA	■ NOIR MAT	ALUMINIUM	21W	3000K	407	1850Lm	1475Lm	12°	407,00
TR379WW05DA	■ NOIR MAT	ALUMINIUM	21W	3000K	407	1850Lm	1510Lm	24°	407,00
TR380WW05DA	■ NOIR MAT	ALUMINIUM	21W	3000K	407	1850Lm	1510Lm	36°	377,00
TR381WW05DA	■ NOIR MAT	ALUMINIUM	26W	3000K	812	2200Lm	1745Lm	12°	609,00
TR382WW05DA	■ NOIR MAT	ALUMINIUM	26W	3000K	812	2200Lm	1805Lm	24°	609,00
TR383WW05DA	■ NOIR MAT	ALUMINIUM	26W	3000K	812	2200Lm	1770Lm	36°	579,00

ARRAS

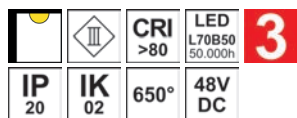

- Structure linéaire pour TRACK 48VDC SURFACE et RECESSED.
- Non dimmable.

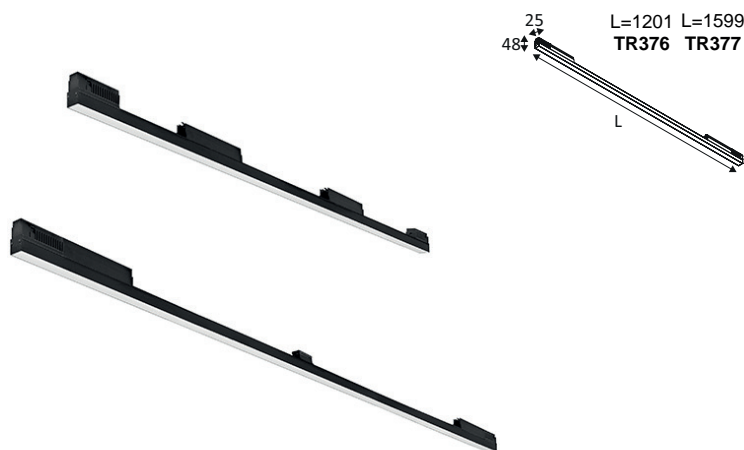

ARRAS	COULEUR	MATIÈRE	P	T°	L(MM)	LED LUMEN	SYSTEM LUMEN	α	€
NON DIMMABLE									
TR376WW05	■ NOIR MAT	ALUMINIUM	26W	3000K	1201	3330Lm	1250Lm	110°	174,00
TR377WW05	■ NOIR MAT	ALUMINIUM	35W	3000K	1599	4330Lm	1630Lm	110°	233,00

LEGA D

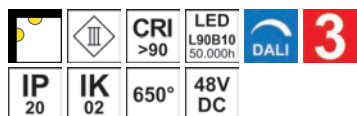

- Structure linéaire pour TRACK 48VDC SURFACE et RECESSED.
- Dimmable DALI.



LEGA D	COULEUR	MATIÈRE	P	T°	L(MM)	LED LUMEN	SYSTEM LUMEN	α	€
DIMMABLE DALI									
TR364WW05DA	■ NOIR MAT	ALUMINIUM	23W	3000K	1200	2850Lm	1735Lm	110°	304,00
TR364NW05DA	■ NOIR MAT	ALUMINIUM	23W	4000K	1200	2950Lm	1815Lm	110°	304,00

LEGA D

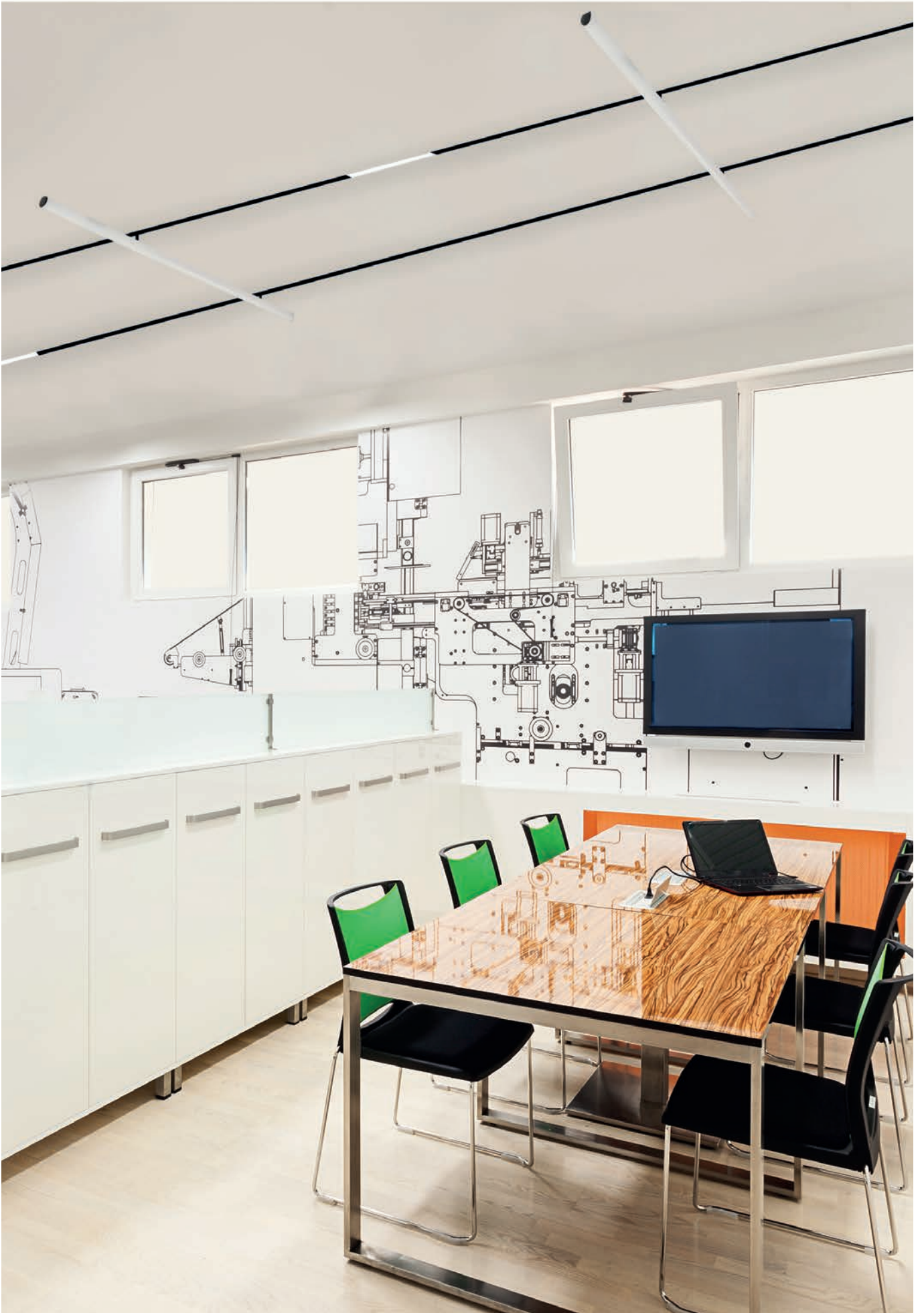

IRO 1

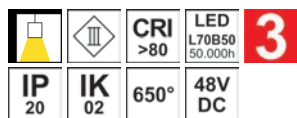

- Suspension pour TRACK 48VDC SURFACE et RECESSED.
- Livrée avec une longueur de câble réglable de 1.50m.



IRO 1	COULEUR	MATIÈRE	P	T°	LED LUMEN	SYSTEM LUMEN	α	€
NON DIMMABLE								
TR311SW05	■ NOIR MAT	ALUMINIUM	8W	2700K	640Lm	465Lm	50°	88,00
TR311WW05	■ NOIR MAT	ALUMINIUM	8W	3000K	660Lm	470Lm	50°	88,00
TR311NW05	■ NOIR MAT	ALUMINIUM	8W	4000K	690Lm	485Lm	50°	88,00
DIMMABLE DALI								
TR311WW05DA	■ NOIR MAT	ALUMINIUM	8W	3000K	660Lm	470Lm	50°	191,00
TR311NW05DA	■ NOIR MAT	ALUMINIUM	8W	4000K	690Lm	485Lm	50°	191,00

IRO 2

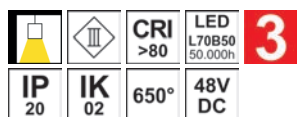

- Suspension pour TRACK 48VDC SURFACE et RECESSED.
- Livrée avec une longueur de câble réglable de 1.50m.

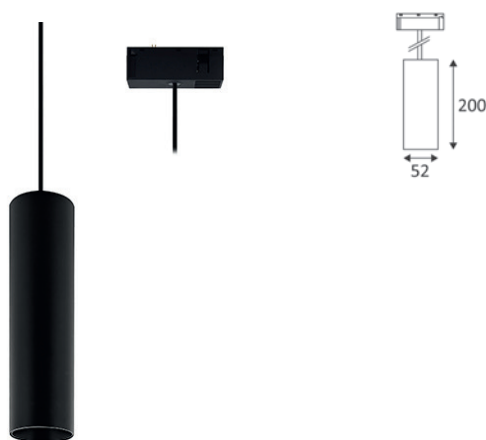

IRO 2	COULEUR	MATIÈRE	P	T°	LED LUMEN	SYSTEM LUMEN	α	€
NON DIMMABLE								
TR312SW05	■ NOIR MAT	ALUMINIUM	19W	2700K	1850Lm	1200Lm	50°	124,00
TR312WW05	■ NOIR MAT	ALUMINIUM	19W	3000K	2050Lm	1215Lm	50°	124,00
TR312NW05	■ NOIR MAT	ALUMINIUM	19W	4000K	2270Lm	1650Lm	50°	124,00
DIMMABLE DALI								
TR312WW05DA	■ NOIR MAT	ALUMINIUM	19W	3000K	2050Lm	1215Lm	50°	222,00
TR312NW05DA	■ NOIR MAT	ALUMINIUM	19W	4000K	2270Lm	1650Lm	50°	222,00

IRO 1



INDIGO

LIGHTING



RAILS & PROJECTEURS DECO TRACK 48



DECO TRACK 48 L

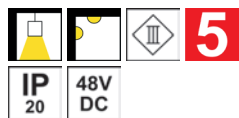

- Rail 48VDC pour montage en saillie.
- Hauteur de 47mm permettant l'intégration complète des modules linéaires et des convertisseurs avec adaptateur pour DECO TRACK 48 pour un design élégant et épuré.
- Convertisseur non-dimmable ou dimmable DALI-PUSH à commander séparément.

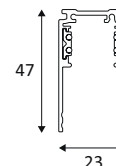

DECO TRACK 48 L		COULEUR	MATIÈRE	L(MM)	€	
TR47705	NEW		NOIR MAT	ALUMINIUM	1000	80,00
TR47805	NEW		NOIR MAT	ALUMINIUM	2000	160,00
TR47905	NEW		NOIR MAT	ALUMINIUM	3000	240,00

ACCESSOIRES		COULEUR	MATIÈRE	DESCRIPTION	L(MM)	€
ALIMENTATIONS						
TR48005	NEW	NOIR MAT	PLASTIQUE	CONNECTEUR D'ALIMENTATION GAUCHE		40,00
TR48105	NEW	NOIR MAT	PLASTIQUE	CONNECTEUR D'ALIMENTATION DROIT		40,00
CONNECTEURS						
TR48605	NEW	NOIR MAT	PLASTIQUE	CONNECTEUR I + RENFORT MECANIQUE POUR RAILS M & L		40,00
TR49305	NEW	NOIR MAT	ALUMINIUM	PROFIL DE CONNEXION 90° GAUCHE PLAFOND POUR RAIL L		40,00
TR49405	NEW	NOIR MAT	ALUMINIUM	PROFIL DE CONNEXION 90° DROIT PLAFOND POUR RAIL L		40,00
TR48805	NEW	NOIR MAT	PLASTIQUE	CONNECTEUR L 90°		40,00
TR49705	NEW	NOIR MAT	ALUMINIUM	PROFIL DE CONNEXION 90° MUR POUR RAIL L		40,00
TR48505	NEW	NOIR MAT	PLASTIQUE	CONNECTEUR FLEXIBLE		40,00
CONVERTISSEURS						
CD182	NEW	NOIR MAT	COMPOSITE	CONVERTISSEUR IN-TRACK 100W 48V		150,00
CD183	NEW	NOIR MAT	COMPOSITE	CONVERTISSEUR IN-TRACK 250W 48V		200,00
CONVERTISSEURS DIMMABLES						
CD184	NEW		ALUMINIUM	CONVERTISSEUR 200W 48V DALI-PUSH		300,00
CD185	NEW		ALUMINIUM	CONVERTISSEUR 100W 48V DALI-PUSH		200,00



ACCESSOIRES		COULEUR	MATIÈRE	DESCRIPTION	L(MM)		€
ACCESSOIRES DE FIXATION							
TR49905	NEW	NOIR MAT	PLASTIQUE	SUPPORT DE FIXATION POUR RAILS M & L	11		5,00
TR49805	NEW	NOIR MAT	PLASTIQUE	KIT DE SUSPENSION 300CM POUR RAILS M & L	62		20,00
TR50305	NEW	NOIR MAT	INOX	PIECE DE RENFORT + SUSPENSION 300CM POUR RAILS M & L	120		40,00
MOULURES							
TR50005	NEW	NOIR MAT	PLASTIQUE	MOULURE DE FINITION 100CM POUR RAILS S & L	1000		8,00
TR50105	NEW	NOIR MAT	PLASTIQUE	MOULURE DE FINITION 200CM POUR RAILS S & L	2000		16,00
TR50205	NEW	NOIR MAT	PLASTIQUE	MOULURE DE FINITION 300CM POUR RAILS S & L	3000		25,00
EMBOUTS							
TR48405	NEW	NOIR MAT	PLASTIQUE	EMBOUT DE FINITION POUR RAIL L	47		5,00

DECO TRACK 48 M

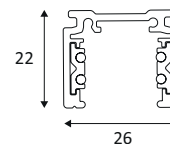

- Rail 48VDC pour montage en saillie.
- Hauteur de 22mm pour un design minimaliste.
- Convertisseur non-dimmable ou dimmable DALI-PUSH à commander séparément.

DECO TRACK 48 M	COULEUR	MATIÈRE	L(MM)	€	
TR47105	NEW	NOIR MAT	ALUMINIUM	1000	60,00
TR47205	NEW	NOIR MAT	ALUMINIUM	2000	120,00
TR47305	NEW	NOIR MAT	ALUMINIUM	3000	180,00

ACCESSOIRES	COULEUR	MATIÈRE	DESCRIPTION	L(MM)	€
ALIMENTATIONS					

TR48005	NEW	NOIR MAT	PLASTIQUE	CONNECTEUR D'ALIMENTATION GAUCHE		40,00
---------	------------	----------	-----------	----------------------------------	--	-------

TR48105	NEW	NOIR MAT	PLASTIQUE	CONNECTEUR D'ALIMENTATION DROIT		40,00
---------	------------	----------	-----------	---------------------------------	--	-------

CONNECTEURS						
TR48605	NEW	NOIR MAT	PLASTIQUE	CONNECTEUR I + RENFORT MECANIQUE POUR RAILS M & L	144	40,00

TR48905	NEW	NOIR MAT	ALUMINIUM	PROFIL DE CONNEXION 90° GAUCHE PLAFOND POUR RAIL M		40,00
---------	------------	----------	-----------	--	--	-------

TR49005	NEW	NOIR MAT	ALUMINIUM	PROFIL DE CONNEXION 90° DROIT PLAFOND POUR RAIL M		40,00
---------	------------	----------	-----------	---	--	-------

TR48805	NEW	NOIR MAT	PLASTIQUE	CONNECTEUR L 90°		40,00
---------	------------	----------	-----------	------------------	--	-------

TR49505	NEW	NOIR MAT	ALUMINIUM	PROFIL DE CONNEXION 90° MUR POUR RAIL M		40,00
---------	------------	----------	-----------	---	--	-------

TR48505	NEW	NOIR MAT	PLASTIQUE	CONNECTEUR FLEXIBLE		40,00
---------	------------	----------	-----------	---------------------	--	-------





CONVERTISSEURS						
CD182	NEW	NOIR MAT	COMPOSITE	CONVERTISSEUR IN-TRACK 100W 48V	268	150,00

CD183	NEW	NOIR MAT	COMPOSITE	CONVERTISSEUR IN-TRACK 250W 48V	268	200,00
-------	------------	----------	-----------	---------------------------------	-----	--------

CONVERTISSEURS DIMMABLES						
CD184	NEW	ALUMINIUM	ALUMINIUM	CONVERTISSEUR 200W 48V DALI-PUSH	369	300,00

CD185	NEW	ALUMINIUM	ALUMINIUM	CONVERTISSEUR 100W 48V DALI-PUSH	355	200,00
-------	------------	-----------	-----------	----------------------------------	-----	--------



ACCESSOIRES		COULEUR	MATIÈRE	DESCRIPTION	L(MM)		€
ACCESSOIRES DE FIXATION							
TR49905	NEW	NOIR MAT	PLASTIQUE	SUPPORT DE FIXATION POUR RAILS M & L	28		5,00
TR49805	NEW	NOIR MAT	PLASTIQUE	KIT DE SUSPENSION 300CM POUR RAILS M & L	62		20,00
TR50305	NEW	NOIR MAT	INOX	PIECE DE RENFORT + SUSPENSION 300CM POUR RAILS M & L	120		40,00
EMBOUTS							
TR48205	NEW	NOIR MAT	PLASTIQUE	EMBOUT DE FINITION POUR RAIL M	22		5,00

DECO TRACK 48 S

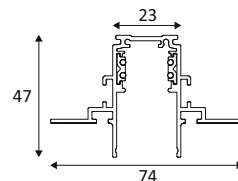
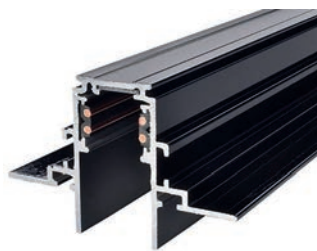
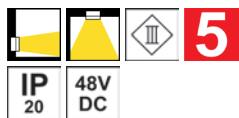





- Rail 48VDC pour montage encastré.
- Intégration complète des modules linéaires et des convertisseurs avec adaptateur pour DECO TRACK 48 pour un design élégant et épuré.
- Convertisseur non-dimmable ou dimmable DALI-PUSH à commander séparément.

DECO TRACK 48 S	COULEUR	MATIÈRE	L(MM)	€	
TR47405	NEW	■ NOIR MAT	ALUMINIUM	1000	90,00
TR47505	NEW	■ NOIR MAT	ALUMINIUM	2000	180,00
TR47605	NEW	■ NOIR MAT	ALUMINIUM	3000	270,00

ACCESSOIRES	COULEUR	MATIÈRE	DESCRIPTION	L(MM)	€
ALIMENTATIONS					
TR48005	NEW	■ NOIR MAT	CONNECTEUR D'ALIMENTATION GAUCHE		40,00
TR48105	NEW	■ NOIR MAT	CONNECTEUR D'ALIMENTATION DROIT		40,00
CONNECTEURS					
TR48705	NEW	■ NOIR MAT	CONNECTEUR I + RENFORTS MECANIQUES POUR RAIL S		40,00
TR49105	NEW	■ NOIR MAT	PROFIL DE CONNEXION 90° GAUCHE PLAFOND POUR RAIL S		40,00
TR49205	NEW	■ NOIR MAT	PROFIL DE CONNEXION 90° DROIT PLAFOND POUR RAIL S		40,00
TR48805	NEW	■ NOIR MAT	CONNECTEUR L 90°		40,00
TR49605	NEW	■ NOIR MAT	PROFIL DE CONNEXION 90° MUR POUR RAIL S		40,00
TR48505	NEW	■ NOIR MAT	CONNECTEUR FLEXIBLE		40,00
CONVERTISSEURS					
CD182	NEW	■ NOIR MAT	CONVERTISSEUR IN-TRACK 100W 48V		150,00
CD183	NEW	■ NOIR MAT	CONVERTISSEUR IN-TRACK 250W 48V		200,00
CONVERTISSEURS DIMMABLES					
CD184	NEW	■ NOIR MAT	CONVERTISSEUR 200W 48V DALI-PUSH		300,00
CD185	NEW	■ NOIR MAT	CONVERTISSEUR 100W 48V DALI-PUSH		200,00



NEW

ACCESSOIRES	COULEUR	MATIÈRE	DESCRIPTION	L(MM)		€
TR50005	NEW NOIR MAT	PLASTIQUE	MOULURE DE FINITION 100CM POUR RAILS S & L	1000		8,00
TR50105	NEW NOIR MAT	PLASTIQUE	MOULURE DE FINITION 200CM POUR RAILS S & L	2000		16,00
TR50205	NEW NOIR MAT	PLASTIQUE	MOULURE DE FINITION 300CM POUR RAILS S & L	3000		25,00
EMBOUS						
TR48305	NEW NOIR MAT	PLASTIQUE	EMBOUT DE FINITION POUR RAIL S		 	5,00

NEW

TORO T

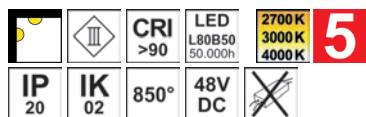

- Module décoratif pour DECO TRACK 48.
- 2700K, 3000K ou 4000K au choix via un interrupteur sur l'adaptateur.
- Dimmable avec un convertisseur DALI-PUSH (CD184, CD185).



TORO T	COULEUR	MATIÈRE	P	T°	LED LUMEN	SYSTEM LUMEN	α	€
TR46905	NEW ■ NOIR MAT	VERRE	5W	2700K 3000K 4000K	400Lm (4000K)	385Lm (4000K)	230°	110,00

NEW

TORO TP

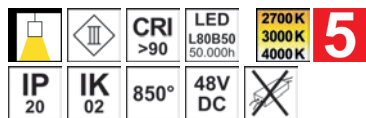

- Suspension décorative pour DECO TRACK 48.
- Câble de suspension réglable de 1m50.
- 2700K, 3000K ou 4000K au choix via un interrupteur sur l'adaptateur.
- Dimmable avec un convertisseur DALI-PUSH (CD184, CD185).



TORO TP	COULEUR	MATIÈRE	P	T°	LED LUMEN	SYSTEM LUMEN	α	€
TR47005	NEW ■ NOIR MAT	VERRE	5W	2700K 3000K 4000K	400Lm (4000K)	385Lm (4000K)	230°	130,00



SANDO T

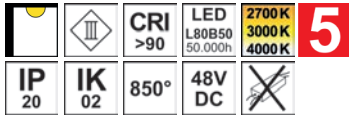

- Module décoratif pour DECO TRACK 48.
- 2700K, 3000K ou 4000K au choix via un interrupteur sur l'adaptateur.
- Dimmable avec un convertisseur DALI-PUSH (CD184, CD185).

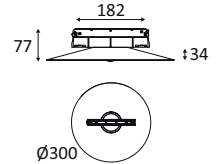

NEW

SANDO T	COULEUR	MATIÈRE	P	T°	LED LUMEN	SYSTEM LUMEN	α	€
TR45605	NEW NOIR MAT	ALUMINIUM	7W	2700K 3000K 4000K	850Lm (4000K)	615Lm (4000K)	36°	160,00

SANDO TP

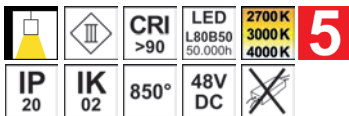

- Suspension décorative pour DECO TRACK 48.
- Câble de suspension réglable de 1m50.
- 2700K, 3000K ou 4000K au choix via un interrupteur sur l'adaptateur.
- Dimmable avec un convertisseur DALI-PUSH (CD184, CD185).

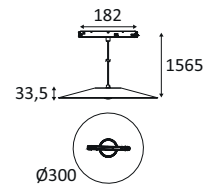

NEW

SANDO TP	COULEUR	MATIÈRE	P	T°	LED LUMEN	SYSTEM LUMEN	α	€
TR45705	NEW NOIR MAT	ALUMINIUM	7W	2700K 3000K 4000K	850Lm (4000K)	615Lm (4000K)	36°	170,00

DALMA T

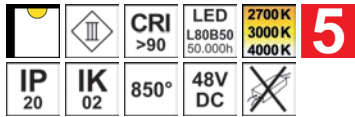

- Module décoratif à éclairage indirect pour DECO TRACK 48.
- 2700K, 3000K ou 4000K au choix via un interrupteur sur l'adaptateur.
- Dimmable avec un convertisseur DALI-PUSH (CD184, CD185).

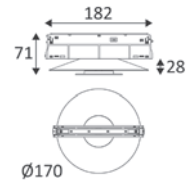

DALMA T	COULEUR	MATIÈRE	P	T°	LED LUMEN	SYSTEM LUMEN	α	€
TR45805	NEW ■ NOIR MAT	ALUMINIUM	7W	2700K 3000K 4000K	1000Lm (4000K)	245Lm (4000K)	155°	150,00





NEW

TONKA

		CRI >90	LED L80B50 50.000h	2700K 3000K 4000K	5
IP 20	IK 02	90°	350°	850°	48V DC

- Projecteur pour éclairage d'accentuation pour DECO TRACK 48.
- 2700K, 3000K ou 4000K au choix via un interrupteur sur l'adaptateur.
- Dimmable avec un convertisseur DALI-PUSH (CD184, CD185).

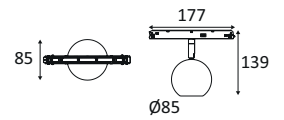

TONKA	COULEUR	MATIÈRE	P	T°	LED LUMEN	SYSTEM LUMEN	α	€
TR46805	NEW ■ NOIR MAT	ALUMINIUM	7W	2700K 3000K 4000K	1050Lm (4000K)	630Lm (4000K)	38°	150,00



DISU 1

		CRI >90	LED L80B50 50.000h	UGR <15	2700K 3000K 4000K	5
IP 20	IK 02	90°	350°	850°	48V DC	

- Projecteur pour éclairage d'accentuation pour DECO TRACK 48.
- 2700K, 3000K ou 4000K au choix via un interrupteur sur l'adaptateur.
- Dimmable avec un convertisseur DALI-PUSH (CD184, CD185).

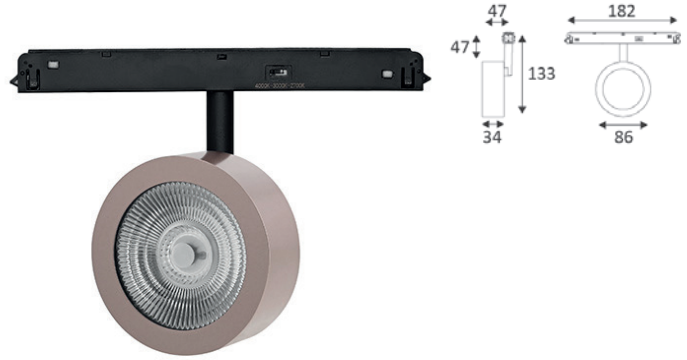

DISU 1	COULEUR	MATIÈRE	P	T°	LED LUMEN	SYSTEM LUMEN	α	€
TR45205	NEW ■ NOIR MAT	ALUMINIUM	7W	2700K 3000K 4000K	1100Lm (4000K)	665Lm (4000K)	40°	120,00
TR45235	NEW ▣ NOIR MAT - BLANC MAT	ALUMINIUM	7W	2700K 3000K 4000K	1100Lm (4000K)	665Lm (4000K)	40°	125,00
TR45208	NEW ▤ NOIR MAT - DORÉ	ALUMINIUM	7W	2700K 3000K 4000K	1100Lm (4000K)	665Lm (4000K)	40°	125,00
TR45206	NEW ▥ NOIR MAT - OR ROSE	ALUMINIUM	7W	2700K 3000K 4000K	1100Lm (4000K)	665Lm (4000K)	40°	125,00



NOIR MAT NOIR MAT - BLANC MAT NOIR MAT - DORÉ NOIR MAT - OR ROSE





NEW

DISU 2

		CRI >90	LED L80B50 50.000h	UGR <15	2700K 3000K 4000K	5
IP 20	IK 02	 90°	 350°	 850°	48V DC	

- Projecteur pour éclairage d'accentuation pour DECO TRACK 48.
- 2700K, 3000K ou 4000K au choix via un interrupteur sur l'adaptateur.
- Dimmable avec un convertisseur DALI-PUSH (CD184, CD185).

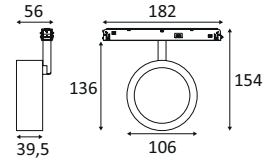

DISU 2	COULEUR	MATIÈRE	P	T°	LED LUMEN	SYSTEM LUMEN	α	€
TR45305	NEW NOIR MAT	ALUMINIUM	15W	2700K 3000K 4000K	2100Lm (4000K)	1595Lm (4000K)	36°	140,00
TR45335	NEW NOIR MAT - BLANC MAT	ALUMINIUM	15W	2700K 3000K 4000K	2100Lm (4000K)	1595Lm (4000K)	36°	145,00
TR45308	NEW NOIR MAT - DORÉ	ALUMINIUM	15W	2700K 3000K 4000K	2100Lm (4000K)	1595Lm (4000K)	36°	145,00
TR45306	NEW NOIR MAT - OR ROSE	ALUMINIUM	15W	2700K 3000K 4000K	2100Lm (4000K)	1595Lm (4000K)	36°	145,00

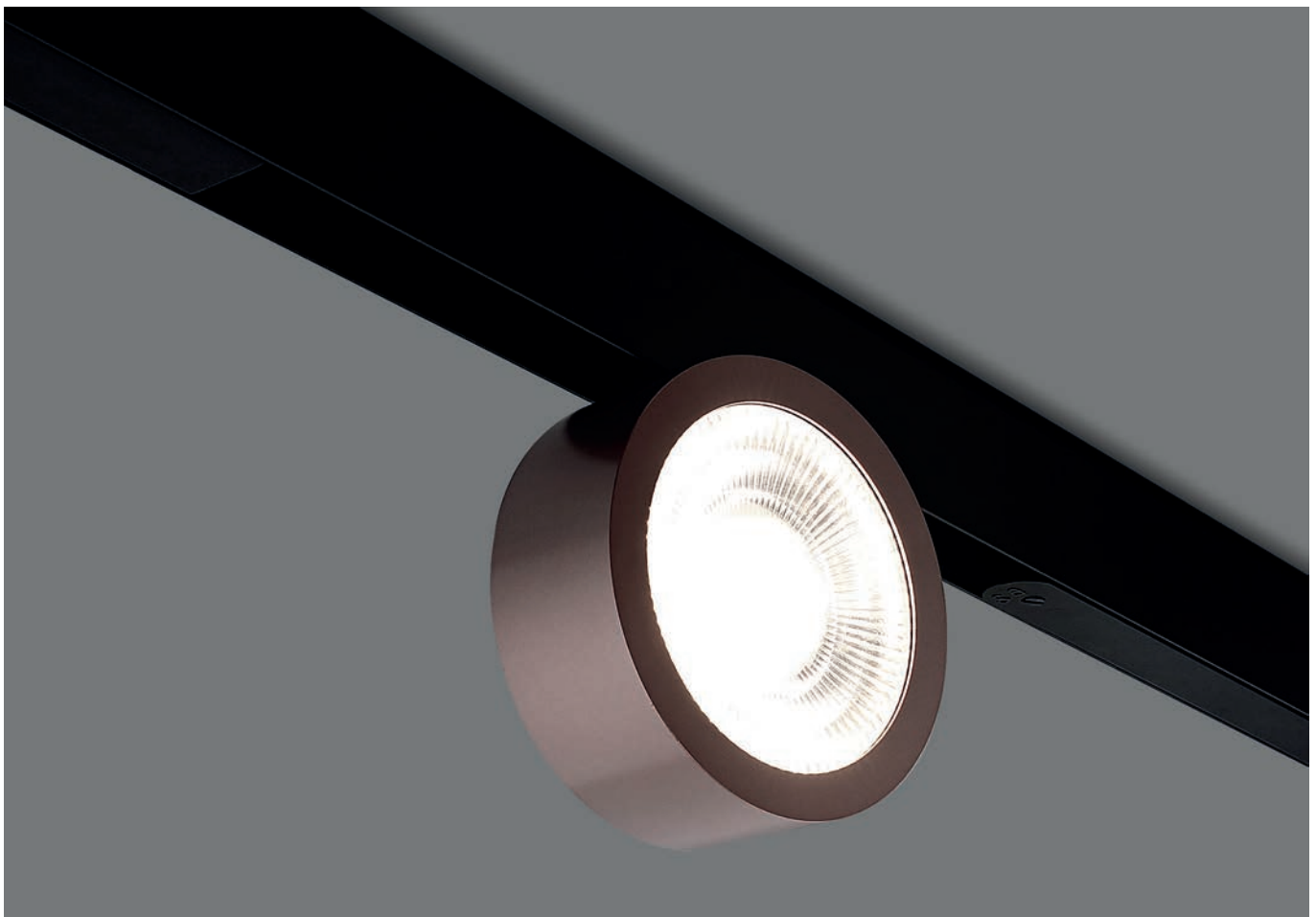

ZUMU

		CRI >90	LED L80B50 50.000h	2700K 3000K 4000K	5
IP 20	IK 02	90°	350°	850°	48V DC

- Projecteur pour éclairage d'accentuation pour DECO TRACK 48.
- Faisceau ajustable de 25° à 75°.
- 2700K, 3000K ou 4000K au choix via un interrupteur sur l'adaptateur.
- Dimmable avec un convertisseur DALI-PUSH (CD184, CD185).



ZUMU	COULEUR	MATIÈRE	P	T°	LED LUMEN	SYSTEM LUMEN	α	€
TR46705	NEW ■ NOIR MAT	ALUMINIUM	15W	2700K 3000K 4000K	1950Lm (4000K)	1405Lm (4000K)	25-75°	200,00

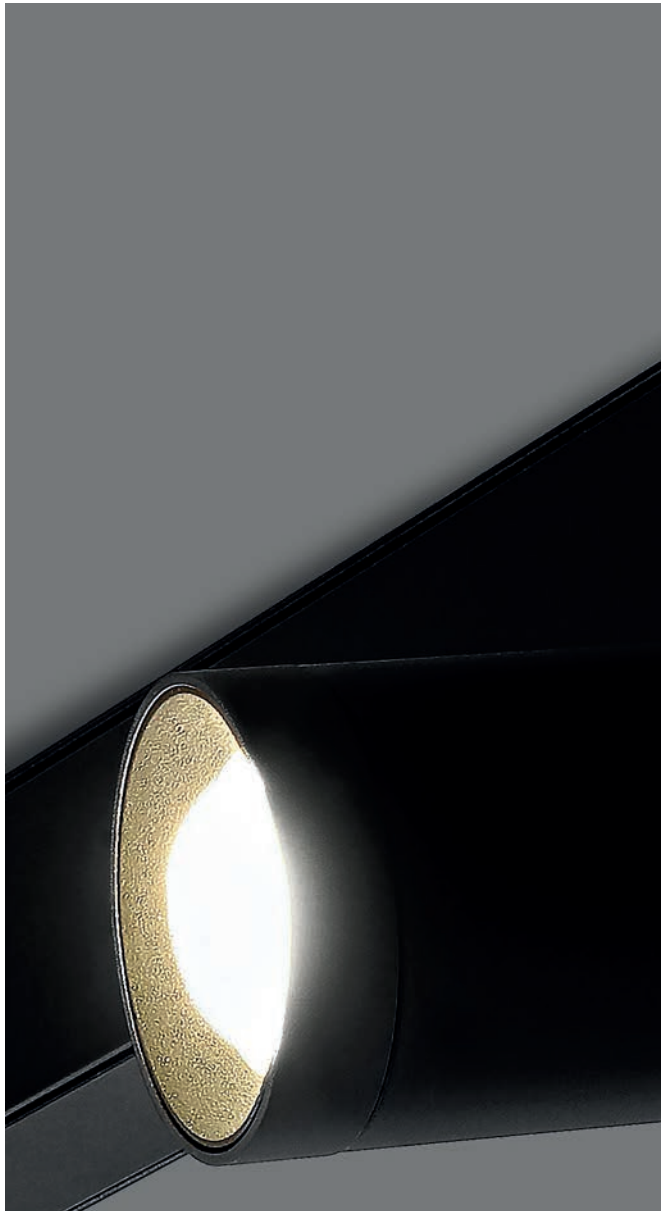



NEW

YOKO 1

- Projecteur pour éclairage d'accentuation pour DECO TRACK 48.
- Cylindre lisse.
- 2700K, 3000K ou 4000K au choix via un interrupteur sur l'adaptateur.
- Dimmable avec un convertisseur DALI-PUSH (CD184, CD185).

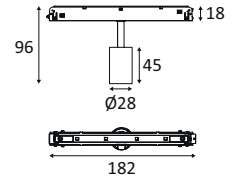

YOKO 1	COULEUR	MATIÈRE	P	T°	LED LUMEN	SYSTEM LUMEN	α	€
TR45905	NEW NOIR MAT	ALUMINIUM	4W	2700K 3000K 4000K	300Lm (4000K)	215Lm (4000K)	30°	90,00
TR45935	NEW NOIR MAT - BLANC MAT	ALUMINIUM	4W	2700K 3000K 4000K	300Lm (4000K)	215Lm (4000K)	30°	95,00
TR45908	NEW NOIR MAT - DORÉ	ALUMINIUM	4W	2700K 3000K 4000K	300Lm (4000K)	215Lm (4000K)	30°	95,00
TR45906	NEW NOIR MAT - OR ROSE	ALUMINIUM	4W	2700K 3000K 4000K	300Lm (4000K)	215Lm (4000K)	30°	95,00



NOIR MAT NOIR MAT - BLANC MAT NOIR MAT - DORÉ NOIR MAT - OR ROSE

YOKA 1

- Projecteur pour éclairage d'accentuation pour DECO TRACK 48.
- Cylindre texturé.
- 2700K, 3000K ou 4000K au choix via un interrupteur sur l'adaptateur.
- Dimmable avec un convertisseur DALI-PUSH (CD184, CD185).

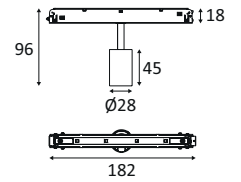

NEW

YOKA 1	COULEUR	MATIÈRE	P	T°	LED LUMEN	SYSTEM LUMEN	α	€
TR46305	NEW NOIR MAT	ALUMINIUM	4W	2700K 3000K 4000K	300Lm (4000K)	215Lm (4000K)	30°	100,00
TR46335	NEW NOIR MAT - BLANC MAT	ALUMINIUM	4W	2700K 3000K 4000K	300Lm (4000K)	215Lm (4000K)	30°	105,00
TR46308	NEW NOIR MAT - DORÉ	ALUMINIUM	4W	2700K 3000K 4000K	300Lm (4000K)	215Lm (4000K)	30°	105,00
TR46306	NEW NOIR MAT - OR ROSE	ALUMINIUM	4W	2700K 3000K 4000K	300Lm (4000K)	215Lm (4000K)	30°	105,00



NOIR MAT NOIR MAT - BLANC MAT NOIR MAT - DORÉ NOIR MAT - OR ROSE

NEW

YOKO 2

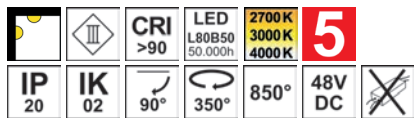

- Projecteur pour éclairage d'accentuation pour DECO TRACK 48.
- Cylindre lisse.
- 2700K, 3000K ou 4000K au choix via un interrupteur sur l'adaptateur.
- Dimmable avec un convertisseur DALI-PUSH (CD184, CD185).



YOKO 2	COULEUR	MATIÈRE	P	T°	LED LUMEN	SYSTEM LUMEN	α	€
TR46005	NEW NOIR MAT	ALUMINIUM	7W	2700K 3000K 4000K	1050Lm (4000K)	620Lm (4000K)	40°	100,00
TR46035	NEW NOIR MAT - BLANC MAT	ALUMINIUM	7W	2700K 3000K 4000K	1050Lm (4000K)	620Lm (4000K)	40°	105,00
TR46008	NEW NOIR MAT - DORÉ	ALUMINIUM	7W	2700K 3000K 4000K	1050Lm (4000K)	620Lm (4000K)	40°	105,00
TR46006	NEW NOIR MAT - OR ROSE	ALUMINIUM	7W	2700K 3000K 4000K	1050Lm (4000K)	620Lm (4000K)	40°	105,00



YOKA 2

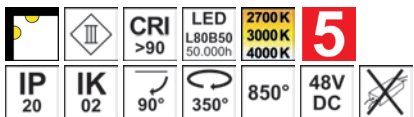

- Projecteur pour éclairage d'accentuation pour DECO TRACK 48.
- Cylindre texturé.
- 2700K, 3000K ou 4000K au choix via un interrupteur sur l'adaptateur.
- Dimmable avec un convertisseur DALI-PUSH (CD184, CD185).



YOKA 2	COULEUR	MATIÈRE	P	T°	LED LUMEN	SYSTEM LUMEN	α	€
TR46405	NEW NOIR MAT	ALUMINIUM	7W	2700K 3000K 4000K	1050Lm (4000K)	620Lm (4000K)	40°	110,00
TR46435	NEW NOIR MAT - BLANC MAT	ALUMINIUM	7W	2700K 3000K 4000K	1050Lm (4000K)	620Lm (4000K)	40°	115,00
TR46408	NEW NOIR MAT - DORÉ	ALUMINIUM	7W	2700K 3000K 4000K	1050Lm (4000K)	620Lm (4000K)	40°	115,00
TR46406	NEW NOIR MAT - OR ROSE	ALUMINIUM	7W	2700K 3000K 4000K	1050Lm (4000K)	620Lm (4000K)	40°	115,00





NEW

YOKO 3

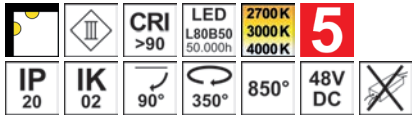

- Projecteur pour éclairage d'accentuation pour DECO TRACK 48.
- Cylindre lisse.
- 2700K, 3000K ou 4000K au choix via un interrupteur sur l'adaptateur.
- Dimmable avec un convertisseur DALI-PUSH (CD184, CD185).

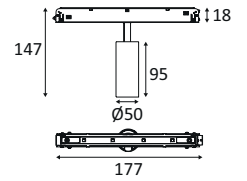

YOKO 3	COULEUR	MATIÈRE	P	T°	LED LUMEN	SYSTEM LUMEN	α	€
TR46105	NEW ■ NOIR MAT	ALUMINIUM	15W	2700K 3000K 4000K	1950Lm (4000K)	1315Lm (4000K)	40°	150,00
TR46135	NEW ▨ NOIR MAT - BLANC MAT	ALUMINIUM	15W	2700K 3000K 4000K	1950Lm (4000K)	1315Lm (4000K)	40°	155,00
TR46108	NEW ▩ NOIR MAT - DORÉ	ALUMINIUM	15W	2700K 3000K 4000K	1950Lm (4000K)	1315Lm (4000K)	40°	155,00
TR46106	NEW ▪ NOIR MAT - OR ROSE	ALUMINIUM	15W	2700K 3000K 4000K	1950Lm (4000K)	1315Lm (4000K)	40°	155,00



YOKA 3

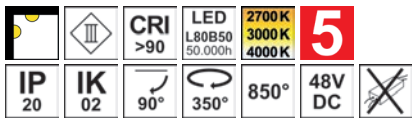

- Projecteur pour éclairage d'accentuation pour DECO TRACK 48.
- Cylindre texturé.
- 2700K, 3000K ou 4000K au choix via un interrupteur sur l'adaptateur.
- Dimmable avec un convertisseur DALI-PUSH (CD184, CD185).

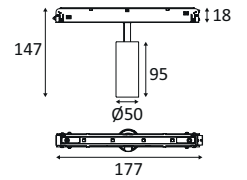

YOKA 3	COULEUR	MATIÈRE	P	T°	LED LUMEN	SYSTEM LUMEN	α	€
TR46505	NEW ■ NOIR MAT	ALUMINIUM	15W	2700K 3000K 4000K	1950Lm (4000K)	1315Lm (4000K)	40°	160,00
TR46535	NEW ▨ NOIR MAT - BLANC MAT	ALUMINIUM	15W	2700K 3000K 4000K	1950Lm (4000K)	1315Lm (4000K)	40°	165,00
TR46508	NEW ▩ NOIR MAT - DORÉ	ALUMINIUM	15W	2700K 3000K 4000K	1950Lm (4000K)	1315Lm (4000K)	40°	165,00
TR46506	NEW ▪ NOIR MAT - OR ROSE	ALUMINIUM	15W	2700K 3000K 4000K	1950Lm (4000K)	1315Lm (4000K)	40°	165,00



NEW

NEW

YOKO 4

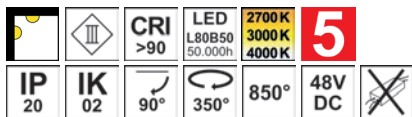

- Projecteur pour éclairage d'accentuation pour DECO TRACK 48.
- Cylindre lisse.
- 2700K, 3000K ou 4000K au choix via un interrupteur sur l'adaptateur.
- Dimmable avec un convertisseur DALI-PUSH (CD184, CD185).



YOKO 4	COULEUR	MATIÈRE	P	T°	LED LUMEN	SYSTEM LUMEN	α	€
TR46205	NEW NOIR MAT	ALUMINIUM	27W	2700K 3000K 4000K	3400Lm (4000K)	2675Lm (4000K)	40°	200,00
TR46235	NEW NOIR MAT - BLANC MAT	ALUMINIUM	27W	2700K 3000K 4000K	3400Lm (4000K)	2675Lm (4000K)	40°	205,00
TR46208	NEW NOIR MAT - DORÉ	ALUMINIUM	27W	2700K 3000K 4000K	3400Lm (4000K)	2675Lm (4000K)	40°	205,00
TR46206	NEW NOIR MAT - OR ROSE	ALUMINIUM	27W	2700K 3000K 4000K	3400Lm (4000K)	2675Lm (4000K)	40°	205,00



YOKA 4

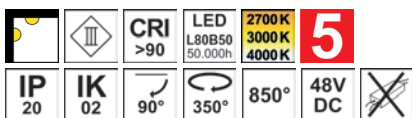

- Projecteur pour éclairage d'accentuation pour DECO TRACK 48.
- Cylindre texturé.
- 2700K, 3000K ou 4000K au choix via un interrupteur sur l'adaptateur.
- Dimmable avec un convertisseur DALI-PUSH (CD184, CD185).



YOKA 4	COULEUR	MATIÈRE	P	T°	LED LUMEN	SYSTEM LUMEN	α	€
TR46605	NEW NOIR MAT	ALUMINIUM	27W	2700K 3000K 4000K	3400Lm (4000K)	2675Lm (4000K)	40°	210,00
TR46635	NEW NOIR MAT - BLANC MAT	ALUMINIUM	27W	2700K 3000K 4000K	3400Lm (4000K)	2675Lm (4000K)	40°	215,00
TR46608	NEW NOIR MAT - DORÉ	ALUMINIUM	27W	2700K 3000K 4000K	3400Lm (4000K)	2675Lm (4000K)	40°	215,00
TR46606	NEW NOIR MAT - OR ROSE	ALUMINIUM	27W	2700K 3000K 4000K	3400Lm (4000K)	2675Lm (4000K)	40°	215,00





NEW

TOMO

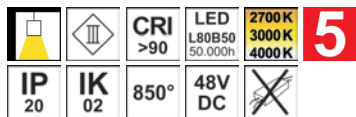

- Suspension pour DECO TRACK 48.
- Cylindre lisse.
- Câble de suspension réglable de 1m50.
- 2700K, 3000K ou 4000K au choix via un interrupteur sur l'adaptateur.
- Dimmable avec un convertisseur DALI-PUSH (CD184, CD185).

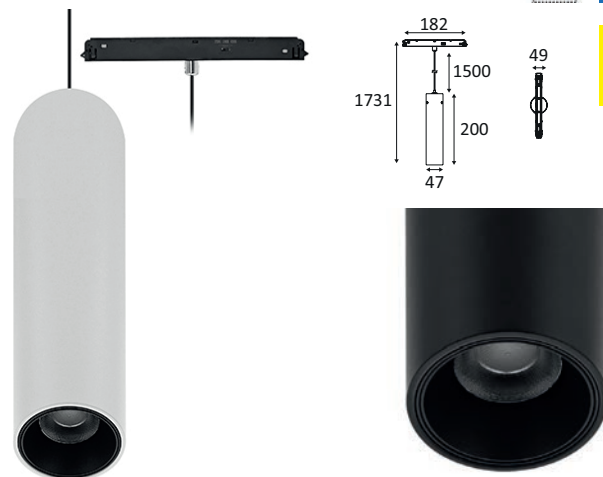

TOMO	COULEUR	MATIÈRE	P	T°	LED LUMEN	SYSTEM LUMEN	α	€
TR45405	NEW ■ NOIR MAT	ALUMINIUM	20W	2700K 3000K 4000K	2300Lm (4000K)	1450Lm (4000K)	40°	150,00
TR45435	NEW ■ NOIR MAT - BLANC MAT	ALUMINIUM	20W	2700K 3000K 4000K	2300Lm (4000K)	1450Lm (4000K)	40°	155,00
TR45408	NEW ■ NOIR MAT - DORÉ	ALUMINIUM	20W	2700K 3000K 4000K	2300Lm (4000K)	1450Lm (4000K)	40°	155,00
TR45406	NEW ■ NOIR MAT - OR ROSE	ALUMINIUM	20W	2700K 3000K 4000K	2300Lm (4000K)	1450Lm (4000K)	40°	155,00



TOMA

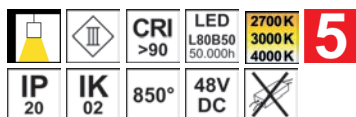

- Suspension pour DECO TRACK 48.
- Cylindre texturé.
- Câble de suspension réglable de 1m50.
- 2700K, 3000K ou 4000K au choix via un interrupteur sur l'adaptateur.
- Dimmable avec un convertisseur DALI-PUSH (CD184, CD185).

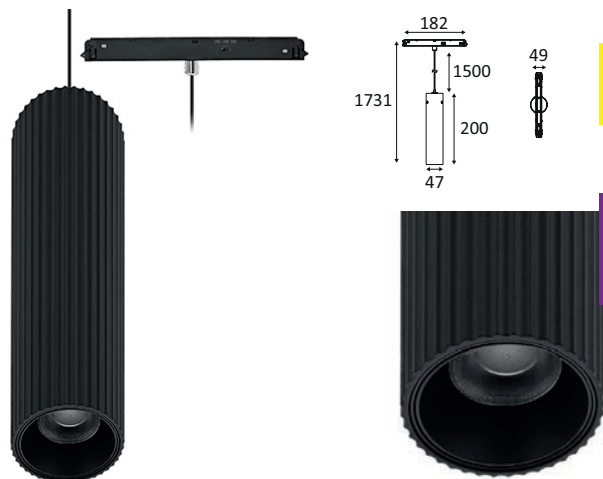

TOMA	COULEUR	MATIÈRE	P	T°	LED LUMEN	SYSTEM LUMEN	α	€
TR45505	NEW ■ NOIR MAT	ALUMINIUM	20W	2700K 3000K 4000K	2300Lm (4000K)	1450Lm (4000K)	40°	160,00
TR45535	NEW ■ NOIR MAT - BLANC MAT	ALUMINIUM	20W	2700K 3000K 4000K	2300Lm (4000K)	1450Lm (4000K)	40°	165,00
TR45508	NEW ■ NOIR MAT - DORÉ	ALUMINIUM	20W	2700K 3000K 4000K	2300Lm (4000K)	1450Lm (4000K)	40°	165,00
TR45506	NEW ■ NOIR MAT - OR ROSE	ALUMINIUM	20W	2700K 3000K 4000K	2300Lm (4000K)	1450Lm (4000K)	40°	165,00

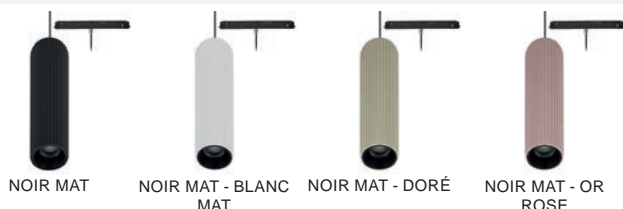

NEW

RAITO 1

		CRI >90	LED L80B50 50.000h	2700K 3000K 4000K	5
IP 20	IK 02	850°	48V DC		

- Module linéaire pour DECO TRACK 48.
- 2700K, 3000K ou 4000K au choix via un interrupteur sur l'adaptateur.
- Dimmable avec un convertisseur DALI-PUSH (CD184, CD185).

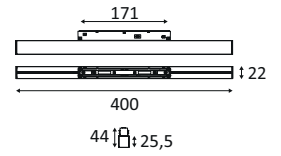

RAITO 1	COULEUR	MATIÈRE	P	T°	LED LUMEN	SYSTEM LUMEN	α	€
TR44505	NEW ■ NOIR MAT	ALUMINIUM	11W	2700K 3000K 4000K	1950Lm (4000K)	1005Lm (4000K)	105°	150,00

RAITO 2

		CRI >90	LED L80B50 50.000h	2700K 3000K 4000K	5
IP 20	IK 02	850°	48V DC		

- Module linéaire pour DECO TRACK 48.
- 2700K, 3000K ou 4000K au choix via un interrupteur sur l'adaptateur.
- Dimmable avec un convertisseur DALI-PUSH (CD184, CD185).

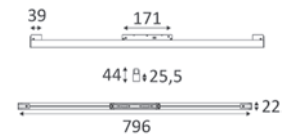

RAITO 2	COULEUR	MATIÈRE	P	T°	LED LUMEN	SYSTEM LUMEN	α	€
TR44605	NEW ■ NOIR MAT	ALUMINIUM	18W	2700K 3000K 4000K	3000Lm (4000K)	1785Lm (4000K)	105°	250,00



NEW

BORU 1

		CRI >90	LED L80B50 50.000h	UGR <11	2700K 3000K 4000K	5
IP 20	IK 02	850°	48V DC			

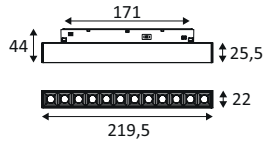

- Module linéaire à basse luminance pour DECO TRACK 48.
- 2700K, 3000K ou 4000K au choix via un interrupteur sur l'adaptateur.
- Dimmable avec un convertisseur DALI-PUSH (CD184, CD185).

BORU 1	COULEUR	MATIÈRE	P	T°	LED LUMEN	SYSTEM LUMEN	α	€
TR44705	NEW ■ NOIR MAT	ALUMINIUM	12W	2700K 3000K 4000K	1350Lm (4000K)	930Lm (4000K)	40°	160,00

BORU 2

		CRI >90	LED L80B50 50.000h	UGR <10	2700K 3000K 4000K	5
IP 20	IK 02	850°	48V DC			

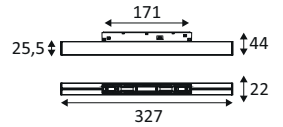

- Module linéaire à basse luminance pour DECO TRACK 48.
- 2700K, 3000K ou 4000K au choix via un interrupteur sur l'adaptateur.
- Dimmable avec un convertisseur DALI-PUSH (CD184, CD185).

NEW

BORU 2	COULEUR	MATIÈRE	P	T°	LED LUMEN	SYSTEM LUMEN	α	€
TR44805	NEW ■ NOIR MAT	ALUMINIUM	21W	2700K 3000K 4000K	2250Lm (4000K)	1505Lm (4000K)	40°	200,00

BORU 3

		CRI >90	LED L80B50 50.000h	UGR <12	2700K 3000K 4000K	5
IP 20	IK 02	850°	48V DC			

- Module linéaire à basse luminance pour DECO TRACK 48.
- 2700K, 3000K ou 4000K au choix via un interrupteur sur l'adaptateur.
- Dimmable avec un convertisseur DALI-PUSH (CD184, CD185).

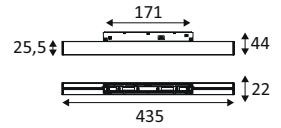

BORU 3	COULEUR	MATIÈRE	P	T°	LED LUMEN	SYSTEM LUMEN	α	€
TR44905	NEW ■ NOIR MAT	ALUMINIUM	25W	2700K 3000K 4000K	2700Lm (4000K)	2020Lm (4000K)	40°	300,00

BORU 4

		CRI >90	LED L80B50 50.000h	UGR <10	2700K 3000K 4000K	5
IP 20	IK 02	850°	48V DC			

- Module linéaire à basse luminance pour DECO TRACK 48.
- 2700K, 3000K ou 4000K au choix via un interrupteur sur l'adaptateur.
- Dimmable avec un convertisseur DALI-PUSH (CD184, CD185).

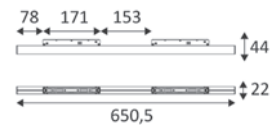

BORU 4	COULEUR	MATIÈRE	P	T°	LED LUMEN	SYSTEM LUMEN	α	€
TR45005	NEW ■ NOIR MAT	ALUMINIUM	40W	2700K 3000K 4000K	4000Lm (4000K)	3100Lm (4000K)	40°	400,00



NEW

MEKA

		CRI >90	LED L80B50 50.000h	UGR <10	2700K 3000K 4000K	5
IP 20	IK 02	90°	850°	48V DC		

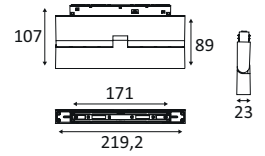

- Module linéaire orientable à basse luminance pour DECO TRACK 48.
- 2700K, 3000K ou 4000K au choix via un interrupteur sur l'adaptateur.
- Dimmable avec un convertisseur DALI-PUSH (CD184, CD185).

MEKA	COULEUR	MATIÈRE	P	T°	LED LUMEN	SYSTEM LUMEN	α	€
TR45105	NEW ■ NOIR MAT	ALUMINIUM	12W	2700K 3000K 4000K	1350Lm (4000K)	1000Lm (4000K)	40°	240,00



INDIGO

LIGHTING



LIGNES CONTINUES

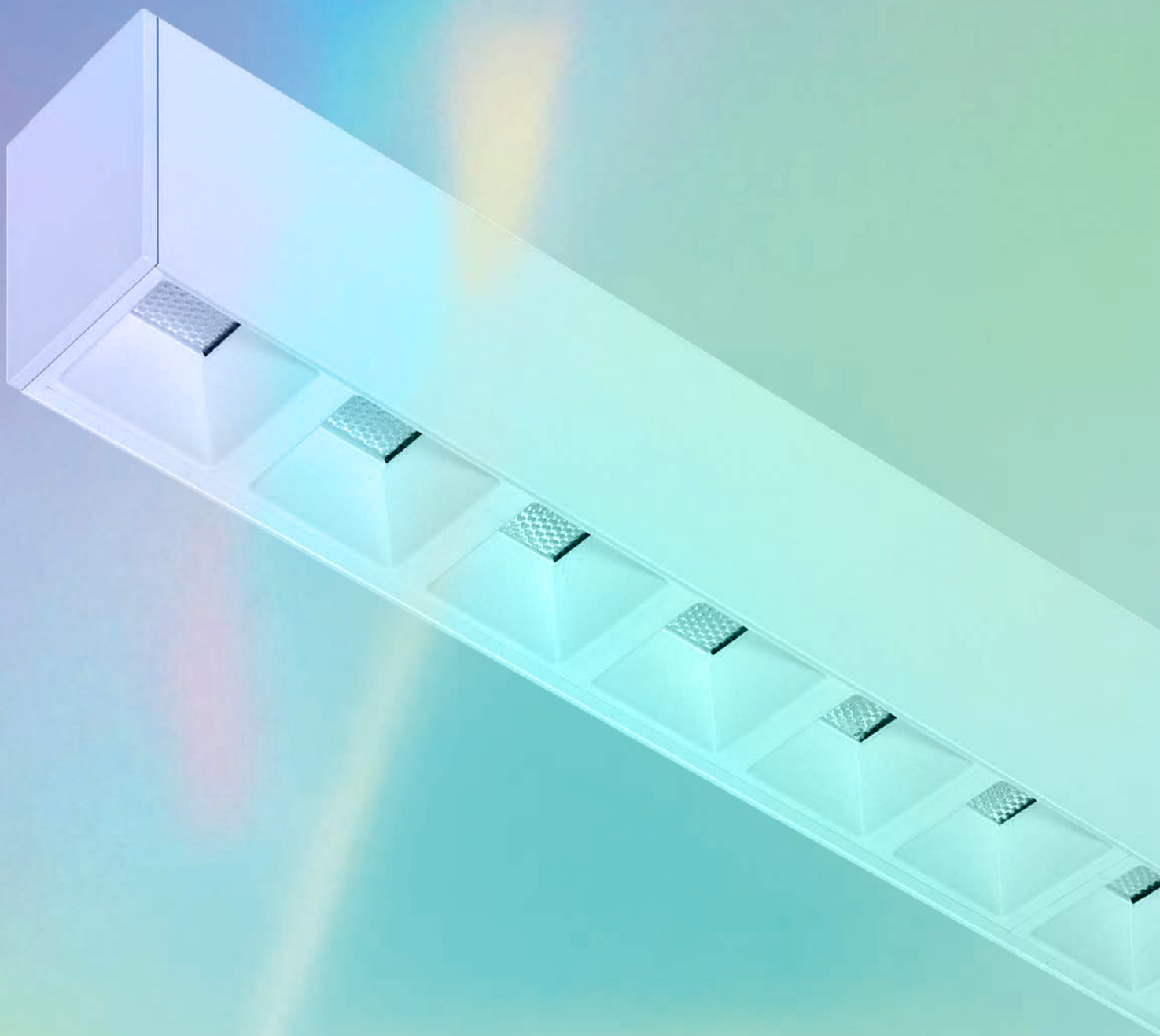

LINEAR 1 C





LINEAR C : MISE EN LIGNE

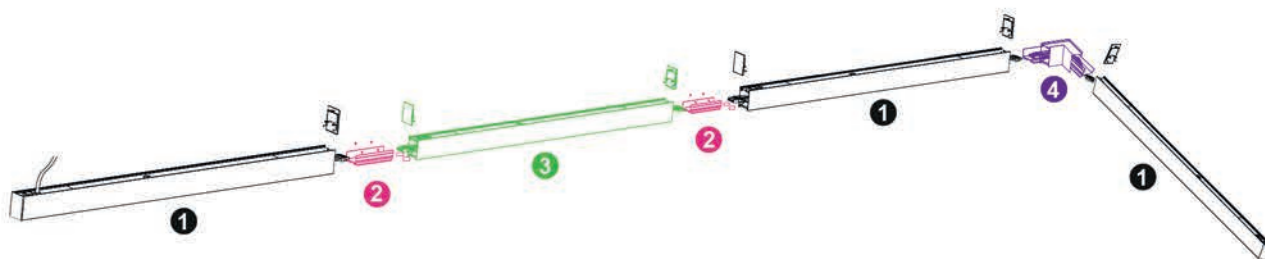

❶ CL100 / CL108 = **LINEAR C**

ACCESSOIRES À COMMANDER SÉPARÉMENT :

- ❷ CL102 = CONNEXION MÉCANIQUE
- ❸ CL104 = MODULE ÉLECTRIFIÉ 120cm
- ❹ CL105 = CONNEXION L

LINEAR P : MISE EN LIGNE

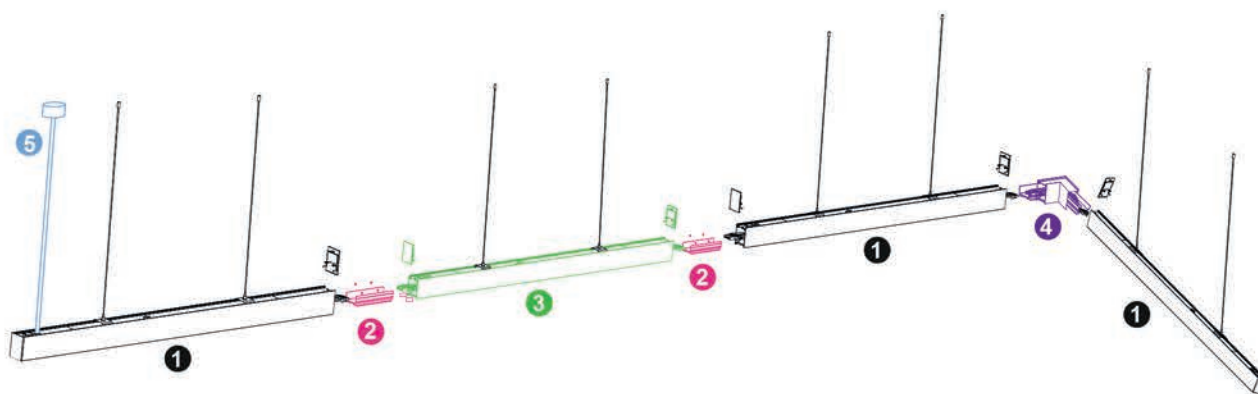

❶ CL101 / CL109 = **LINEAR P**

ACCESSOIRES À COMMANDER SÉPARÉMENT :





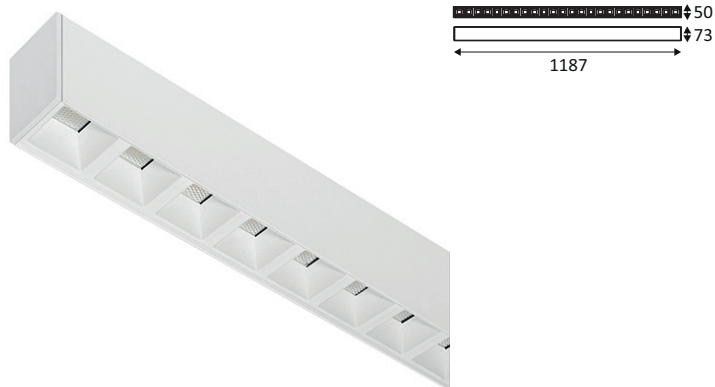



- ❷ CL102 = CONNEXION MÉCANIQUE
- ❸ CL110 = MODULE ÉLECTRIFIÉ 120cm
- ❹ CL105 = CONNEXION L
- ❺ CL103 = CÂBLE D'ALIMENTATION 200cm + BASE

LINEAR 1 C



- Plafonnier linéaire.
- Réflecteur basse luminance.
- 3000K, 3500K ou 4000K au choix via un interrupteur à l'arrière du luminaire.
- Convertisseur non dimmable ou dimmable DALI-push intégré dans l'appareil.
- Possibilité de mise en ligne jusqu'à maximum 25 luminaires.
- Connexion mécanique linéaire à commander séparément.
- Connexions électriques rapides incluses dans le luminaire.

LINEAR 1 C	COULEUR	MATIÈRE	P	T°	L(MM)	LED LUMEN	SYSTEM LUMEN	α	€
NON DIMMABLE									
CL10005	■ NOIR MAT	ALUMINIUM	38W	3000K 3500K 4000K	1187	6625Lm (4000K)	2890Lm (4000K)	75°	179,00
CL10017	▣ NOIR MAT - ARGENT	ALUMINIUM	38W	3000K 3500K 4000K	1187	6625Lm (4000K)	4580Lm (4000K)	75°	179,00
CL10030	■ BLANC MAT	ALUMINIUM	38W	3000K 3500K 4000K	1187	6625Lm (4000K)	4770Lm (4000K)	75°	179,00
CL10053	▣ BLANC MAT - ARGENT	ALUMINIUM	38W	3000K 3500K 4000K	1187	6625Lm (4000K)	4580Lm (4000K)	75°	179,00
DIMMABLE DALI									
CL10005DA	■ NOIR MAT	ALUMINIUM	38W	3000K 3500K 4000K	1187	6625Lm (4000K)	2890Lm (4000K)	75°	232,00
CL10017DA	▣ NOIR MAT - ARGENT	ALUMINIUM	38W	3000K 3500K 4000K	1187	6625Lm (4000K)	4580Lm (4000K)	75°	232,00
CL10030DA	■ BLANC MAT	ALUMINIUM	38W	3000K 3500K 4000K	1187	6625Lm (4000K)	4770Lm (4000K)	75°	232,00
CL10053DA	▣ BLANC MAT - ARGENT	ALUMINIUM	38W	3000K 3500K 4000K	1187	6625Lm (4000K)	4580Lm (4000K)	75°	232,00

ACCESSOIRES	COULEUR	MATIÈRE	DESCRIPTION		€
CL10220		ALUMINIUM	CONNEXION MECANIQUE		7,00
CL10405	■ NOIR MAT	ALUMINIUM	MODULE ELECTRIFIE 120CM		83,00
CL10430	■ BLANC MAT	ALUMINIUM	MODULE ELECTRIFIE 120CM		83,00
CL10505	■ NOIR MAT	ALUMINIUM	CONNEXION L		53,00
CL10530	■ BLANC MAT	ALUMINIUM	CONNEXION L		53,00
CL10605	■ NOIR MAT	ALUMINIUM	CONNEXION T		70,00
CL10630	■ BLANC MAT	ALUMINIUM	CONNEXION T		70,00
CL10705	■ NOIR MAT	ALUMINIUM	CONNEXION X		88,00
CL10730	■ BLANC MAT	ALUMINIUM	CONNEXION X		88,00





LINEAR 2 C

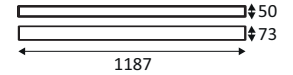
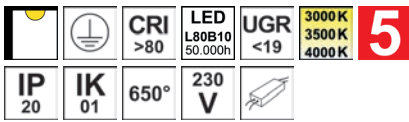

- Plafonnier linéaire.
- Diffuseur PC à structure prismatique.
- Multi-puissance : 21 ou 32W au choix via un interrupteur à l'arrière du luminaire.
- 3000K, 3500K ou 4000K au choix via un interrupteur à l'arrière du luminaire.
- Convertisseur non dimmable ou dimmable DALI-push intégré dans l'appareil.
- Possibilité de mise en ligne jusqu'à maximum 25 luminaires.
- Connexion mécanique linéaire à commander séparément.
- Connexions électriques rapides incluses dans le luminaire.

LINEAR 2 C	COULEUR	MATIÈRE	LED	T°	L(MM)	LED LUMEN	SYSTEM LUMEN	α	€
NON DIMMABLE									
CL10805	■ NOIR MAT	ALUMINIUM	21W 32W	3000K 3500K 4000K	1187	3350 (21W 4000K) 5100 (32W 4000K)	2045 (21W 4000K) 2990 (32W 4000K)	75°	169,00
CL10830	■ BLANC MAT	ALUMINIUM	21W 32W	3000K 3500K 4000K	1187	3350 (21W 4000K) 5100 (32W 4000K)	2560 (21W 4000K) 3740 (32W 4000K)	75°	169,00
DIMMABLE DALI									
CL10805DA	■ NOIR MAT	ALUMINIUM	21W 32W	3000K 3500K 4000K	1187	3350 (21W 4000K) 5100 (32W 4000K)	2040 (21W 4000K) 2990 (32W 4000K)	75°	217,00
CL10830DA	■ BLANC MAT	ALUMINIUM	21W 32W	3000K 3500K 4000K	1187	3350 (21W 4000K) 5100 (32W 4000K)	2560 (21W 4000K) 3740 (32W 4000K)	75°	217,00

ACCESSOIRES	COULEUR	MATIÈRE	DESCRIPTION		€
CL10220		ALUMINIUM	CONNEXION MECANIQUE		7,00
CL10405	NOIR MAT	ALUMINIUM	MODULE ELECTRIFIE 120CM		83,00
CL10430	BLANC MAT	ALUMINIUM	MODULE ELECTRIFIE 120CM		83,00
CL10505	NOIR MAT	ALUMINIUM	CONNEXION L		53,00
CL10530	BLANC MAT	ALUMINIUM	CONNEXION L		53,00
CL10605	NOIR MAT	ALUMINIUM	CONNEXION T		70,00
CL10630	BLANC MAT	ALUMINIUM	CONNEXION T		70,00
CL10705	NOIR MAT	ALUMINIUM	CONNEXION X		88,00
CL10730	BLANC MAT	ALUMINIUM	CONNEXION X		88,00



NOIR MAT

BLANC MAT

LINEAR 1 P

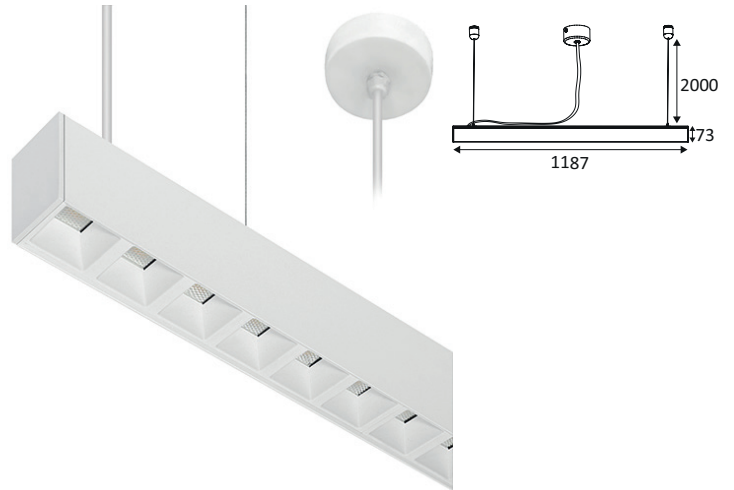
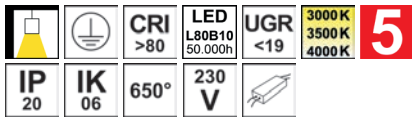

















- Suspension linéaire.
- Réflecteur basse luminance.
- 3000K, 3500K ou 4000K au choix via un interrupteur à l'arrière du luminaire.
- Livrée avec câbles de suspension blancs ou noirs (réglables 2.00m max).
- Base ronde et câble d'alimentation blancs ou noirs (L: 2.00m) à commander séparément.
- Convertisseur non dimmable ou dimmable DALI-push intégré dans l'appareil.
- Possibilité de mise en ligne jusqu'à maximum 25 luminaires.
- Connexion mécanique linéaire à commander séparément.
- Connexions électriques rapides incluses dans le luminaire.

LINEAR 1 P	COULEUR	MATIÈRE	P	T°	L(MM)	LED LUMEN	SYSTEM LUMEN	α	€
NON DIMMABLE									
CL10105	■ NOIR MAT	ALUMINIUM	38W	3000K 3500K 4000K	1187	6625Lm (4000K)	2890Lm (4000K)	75°	185,00
CL10117	▣ NOIR MAT - ARGENT	ALUMINIUM	38W	3000K 3500K 4000K	1187	6625Lm (4000K)	4580Lm (4000K)	75°	186,00
CL10130	■ BLANC MAT	ALUMINIUM	38W	3000K 3500K 4000K	1187	6625Lm (4000K)	4770Lm (4000K)	75°	183,00
CL10153	▣ BLANC MAT - ARGENT	ALUMINIUM	38W	3000K 3500K 4000K	1187	6625Lm (4000K)	4580Lm (4000K)	75°	186,00
DIMMABLE DALI									
CL10105DA	■ NOIR MAT	ALUMINIUM	38W	3000K 3500K 4000K	1187	6625Lm (4000K)	2890Lm (4000K)	75°	239,00
CL10117DA	▣ NOIR MAT - ARGENT	ALUMINIUM	38W	3000K 3500K 4000K	1187	6625Lm (4000K)	4580Lm (4000K)	75°	242,00
CL10130DA	■ BLANC MAT	ALUMINIUM	38W	3000K 3500K 4000K	1187	6625Lm (4000K)	4770Lm (4000K)	75°	239,00
CL10153DA	▣ BLANC MAT - ARGENT	ALUMINIUM	38W	3000K 3500K 4000K	1187	6625Lm (4000K)	4580Lm (4000K)	75°	242,00





LIGNES CONTINUES

ACCESSOIRES	COULEUR	MATIÈRE	DESCRIPTION		€	
CL10220		ALUMINIUM	CONNEXION MECANIQUE			7,00
CL11005	NOIR MAT	ALUMINIUM	MODULE ELECTRIFIE 120CM			101,00
CL11030	BLANC MAT	ALUMINIUM	MODULE ELECTRIFIE 120CM			91,00
CL10305	NOIR		CABLE D'ALIMENTATION 200CM + BASE			13,00
CL10305DA	NOIR		CABLE D'ALIMENTATION DALI 200CM + BASE			18,00
CL10330	BLANC		CABLE D'ALIMENTATION 200CM + BASE			13,00
CL10330DA	BLANC		CABLE D'ALIMENTATION DALI 200CM + BASE			18,00
CL10505	NOIR MAT	ALUMINIUM	CONNEXION L			53,00
CL10530	BLANC MAT	ALUMINIUM	CONNEXION L			53,00
CL10605	NOIR MAT	ALUMINIUM	CONNEXION T			70,00
CL10630	BLANC MAT	ALUMINIUM	CONNEXION T			70,00
CL10705	NOIR MAT	ALUMINIUM	CONNEXION X			88,00
CL10730	BLANC MAT	ALUMINIUM	CONNEXION X			88,00

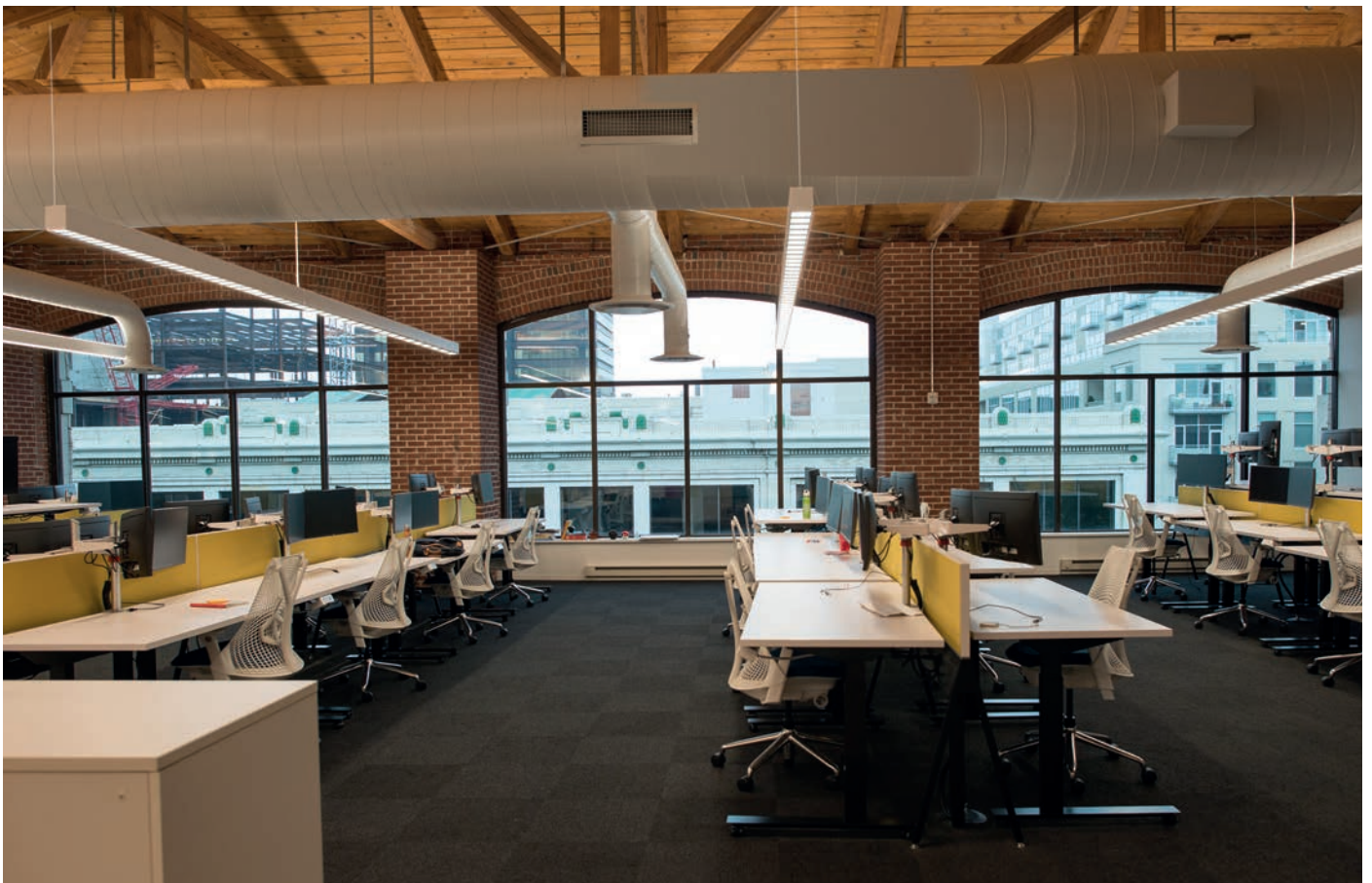

LINEAR 2 P

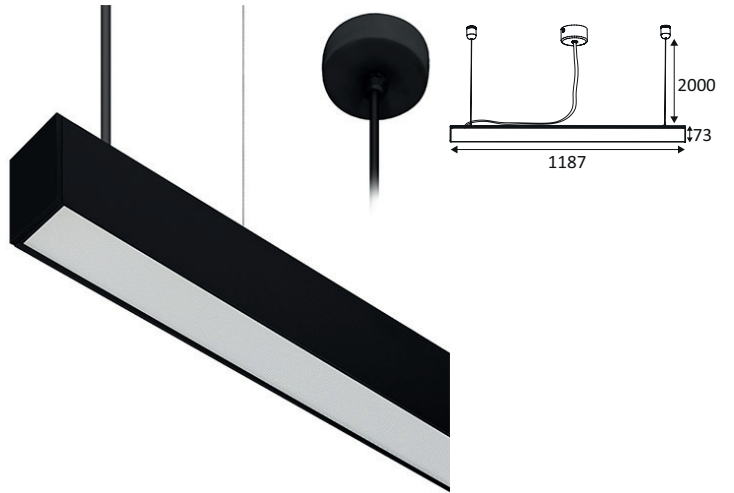
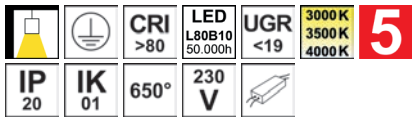

- Suspension linéaire.
- Diffuseur PC à structure prismatique.
- Multi-puissance : 21 ou 32W au choix via un interrupteur à l'arrière du luminaire.
- 3000K, 3500K ou 4000K au choix via un interrupteur à l'arrière du luminaire.
- Livraison avec câbles de suspension blancs ou noirs (réglables 2.00m max).
- Base ronde et câble d'alimentation blancs ou noirs (L: 2.00m) à commander séparément.
- Convertisseur non dimmable ou dimmable DALI-push intégré dans l'appareil.
- Possibilité de mise en ligne jusqu'à maximum 25 luminaires.
- Connexion mécanique linéaire à commander séparément.
- Connexions électriques rapides incluses dans le luminaire.

LINEAR 2 P	COULEUR	MATIÈRE	LED	T°	L(MM)	LED LUMEN	SYSTEM LUMEN	α	€
NON DIMMABLE									
CL10905	■ NOIR MAT	ALUMINIUM	21W 32W	3000K 3500K 4000K	1187	3350 (21W 4000K) 5100 (32W 4000K)	2045 (21W 4000K) 2990 (32W 4000K)	75°	173,00
CL10930	■ BLANC MAT	ALUMINIUM	21W 32W	3000K 3500K 4000K	1187	3350 (21W 4000K) 5100 (32W 4000K)	2560 (21W 4000K) 3740 (32W 4000K)	75°	173,00
DIMMABLE DALI									
CL10905DA	■ NOIR MAT	ALUMINIUM	21W 32W	3000K 3500K 4000K	1187	3350 (21W 4000K) 5100 (32W 4000K)	2045 (21W 4000K) 2990 (32W 4000K)	75°	224,00
CL10930DA	■ BLANC MAT	ALUMINIUM	21W 32W	3000K 3500K 4000K	1187	3350 (21W 4000K) 5100 (32W 4000K)	2560 (21W 4000K) 3740 (32W 4000K)	75°	224,00

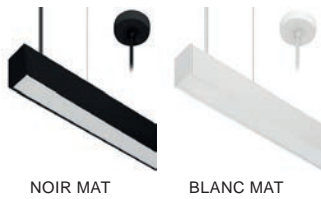











NOIR MAT

BLANC MAT



LIGNES CONTINUES

ACCESSOIRES	COULEUR	MATIÈRE	DESCRIPTION		€
CL10220		ALUMINIUM	CONNEXION MECANIQUE		47,5 120 7,00
CL11005	NOIR MAT	ALUMINIUM	MODULE ELECTRIFIE 120CM		2000 1200 101,00
CL11030	BLANC MAT	ALUMINIUM	MODULE ELECTRIFIE 120CM		91,00
CL10305	NOIR		CABLE D'ALIMENTATION 200CM + BASE		13,00
CL10305DA	NOIR		CABLE D'ALIMENTATION DALI 200CM + BASE		18,00
CL10330	BLANC		CABLE D'ALIMENTATION 200CM + BASE		13,00
CL10330DA	BLANC		CABLE D'ALIMENTATION DALI 200CM + BASE		18,00
CL10505	NOIR MAT	ALUMINIUM	CONNEXION L		99 169 99 53,00
CL10530	BLANC MAT	ALUMINIUM	CONNEXION L		53,00
CL10605	NOIR MAT	ALUMINIUM	CONNEXION T		288 148 169 99 70,00
CL10630	BLANC MAT	ALUMINIUM	CONNEXION T		70,00
CL10705	NOIR MAT	ALUMINIUM	CONNEXION X		288 148 88,00
CL10730	BLANC MAT	ALUMINIUM	CONNEXION X		88,00



INDIGO

LIGHTING



HUBLOTS



MINI TIMY E27

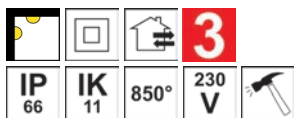

- Applique murale ou plafonnier pour éclairage intérieur et extérieur.
- Avec clé et vis anti-vandale.

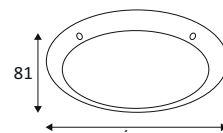

MINI TIMY E27	COULEUR	MATIÈRE	SOQUET	LAMPE	WATT MAX	€
OU44530	NOIR	POLYCARBONATE	E27	CLASSIC A	23W	24,00
OU44531	BLANC	POLYCARBONATE	E27	CLASSIC A	23W	24,00



NOIR



BLANC

MINI TIMY SENSOR E27



- Applique murale ou plafonnier pour éclairage intérieur et extérieur.
- Avec détecteur HF 360°, zone de détection réglable max. 10m de diamètre.
- Fonction maître/esclave possible en association avec le MINI TIMY E27.
- Avec clé et vis anti-vandale.

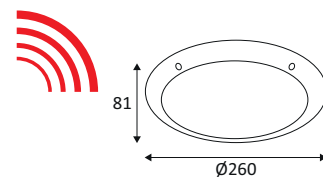

MINI TIMY SENSOR E27	COULEUR	MATIÈRE	SOQUET	LAMPE	WATT MAX	€
OU44630	NOIR	POLYCARBONATE	E27	CLASSIC A	23W	45,00
OU44631	BLANC	POLYCARBONATE	E27	CLASSIC A	23W	45,00



NOIR



BLANC



MINI TIMY

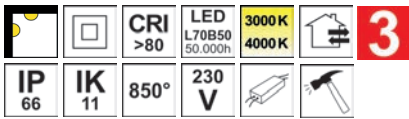

- Applique murale ou plafonnier pour éclairage intérieur et extérieur.
- 3000K ou 4000K au choix via un interrupteur dans le luminaire.
- Avec clé et vis anti-vandale.
- Convertisseur non dimmable intégré dans l'appareil.

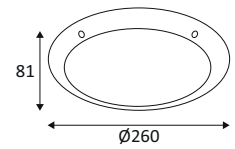

MINI TIMY	COULEUR	MATIÈRE	P	T°	LED LUMEN	SYSTEM LUMEN	α	€
OU395NW30	NOIR	POLYCARBONATE	12W	3000K 4000K	1450Lm (4000K)	1080Lm (4000K)	110°	43,00
OU395NW31	BLANC	POLYCARBONATE	12W	3000K 4000K	1450Lm (4000K)	1080Lm (4000K)	110°	43,00



NOIR



BLANC

MINI TIMY SENSOR

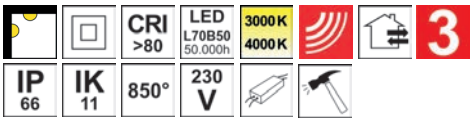

- Applique murale ou plafonnier pour éclairage intérieur et extérieur.
- 3000K ou 4000K au choix via un interrupteur dans le luminaire.
- Avec détecteur HF 360°, zone de détection réglable max. 10m de diamètre.
- Fonction maître/esclave possible en association avec le MINI TIMY.
- Avec clé et vis anti-vandale.
- Convertisseur non dimmable intégré dans l'appareil.

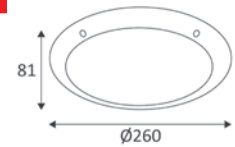

MINI TIMY SENSOR	COULEUR	MATIÈRE	P	T°	LED LUMEN	SYSTEM LUMEN	α	€
OU396NW30	NOIR	POLYCARBONATE	12W	3000K 4000K	1450Lm (4000K)	1080Lm (4000K)	110°	70,00
OU396NW31	BLANC	POLYCARBONATE	12W	3000K 4000K	1450Lm (4000K)	1080Lm (4000K)	110°	70,00



NOIR



BLANC

TIMY

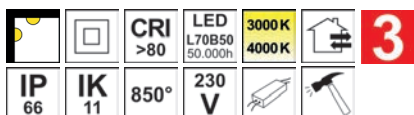

- Applique murale ou plafonnier pour éclairage intérieur et extérieur.
- 3000K ou 4000K au choix via un interrupteur dans le luminaire.
- Avec clé et vis anti-vandale.
- Convertisseur non dimmable intégré dans l'appareil.

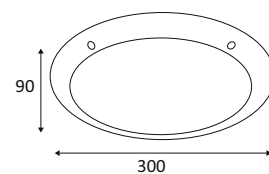

TIMY	COULEUR	MATIÈRE	P	T°	LED LUMEN	SYSTEM LUMEN	α	€
TP1139WW30	NOIR	POLYCARBONATE	25W	3000K 4000K	2350Lm (4000K)	1935Lm (4000K)	110°	84,00
TP1139WW31	BLANC	POLYCARBONATE	25W	3000K 4000K	2350Lm (4000K)	1935Lm (4000K)	110°	84,00



NOIR



BLANC

TIMY SENSOR

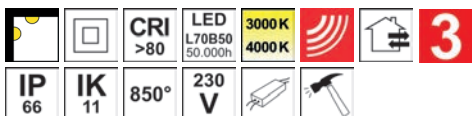

- Applique murale ou plafonnier pour éclairage intérieur et extérieur.
- 3000K ou 4000K au choix via un interrupteur dans le luminaire.
- Avec détecteur HF 360°, zone de détection réglable max. 10m de diamètre.
- Fonction maître/esclave possible en association avec le TIMY.
- Avec clé et vis anti-vandale.
- Convertisseur non dimmable intégré dans l'appareil.

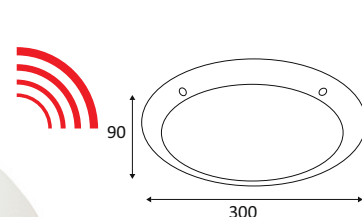

TIMY SENSOR	COULEUR	MATIÈRE	P	T°	LED LUMEN	SYSTEM LUMEN	α	€
OU13930	NOIR	POLYCARBONATE	25W	3000K 4000K	2350Lm (4000K)	1935Lm (4000K)	110°	99,00
OU13931	BLANC	POLYCARBONATE	25W	3000K 4000K	2350Lm (4000K)	1935Lm (4000K)	110°	99,00
OU13920	MÉTAL	POLYCARBONATE	25W	3000K 4000K	2350Lm (4000K)	1935Lm (4000K)	110°	99,00



NOIR



BLANC



MÉTAL



HUBLOTS

TIMY



INDIGO

LIDY

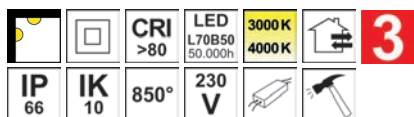

- Applique murale ou plafonnier pour éclairage intérieur et extérieur.
- 3000K ou 4000K au choix via un interrupteur dans le luminaire.
- Avec clé et vis anti-vandale.
- Convertisseur non dimmable intégré dans l'appareil.

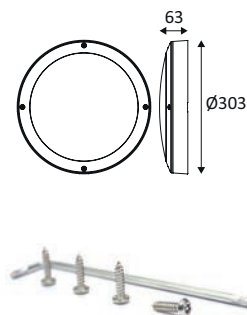

LIDY	COULEUR	MATIÈRE	P	T°	LED LUMEN	SYSTEM LUMEN	α	€
BU10105	NOIR	POLYCARBONATE	24W	3000K 4000K	4010Lm (4000K)	2655Lm (4000K)	110°	65,00
BU10130	BLANC	POLYCARBONATE	24W	3000K 4000K	4010Lm (4000K)	2655Lm (4000K)	110°	65,00



NOIR



BLANC

LIDY SENSOR

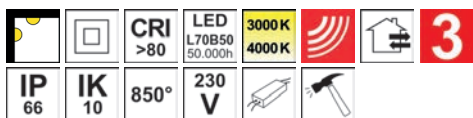

- Applique murale ou plafonnier pour éclairage intérieur et extérieur.
- 3000K ou 4000K au choix via un interrupteur dans le luminaire.
- Avec détecteur HF 360°, zone de détection réglable max. 10m de diamètre.
- Fonction maître/esclave possible en association avec le LIDY.
- Avec clé et vis anti-vandale.
- Convertisseur non dimmable intégré dans l'appareil.

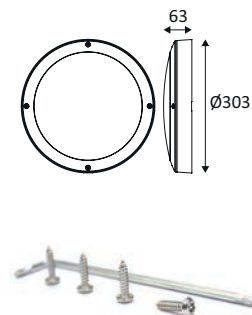

LIDY SENSOR	COULEUR	MATIÈRE	P	T°	LED LUMEN	SYSTEM LUMEN	α	€
BU10205	NOIR	POLYCARBONATE	24W	3000K 4000K	4010Lm (4000K)	2655Lm (4000K)	110°	91,00
BU10230	BLANC	POLYCARBONATE	24W	3000K 4000K	4010Lm (4000K)	2655Lm (4000K)	110°	91,00



NOIR



BLANC



HUBLOTS

LIDY



LIDY A

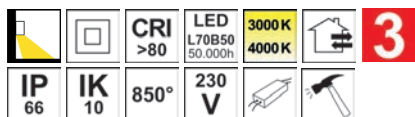

- Applique murale asymétrique pour éclairage intérieur et extérieur.
- 3000K ou 4000K au choix via un interrupteur dans le luminaire.
- Avec clé et vis anti-vandale.
- Convertisseur non dimmable intégré dans l'appareil.

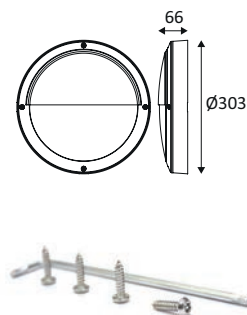

LIDY A	COULEUR	MATIÈRE	P	T°	LED LUMEN	SYSTEM LUMEN	€
BU10305	NOIR	POLYCARBONATE	28W	3000K 4000K	4810Lm (4000K)	2930Lm (4000K)	71,00
BU10330	BLANC	POLYCARBONATE	28W	3000K 4000K	4810Lm (4000K)	2930Lm (4000K)	71,00



NOIR



BLANC

LIDY A SENSOR

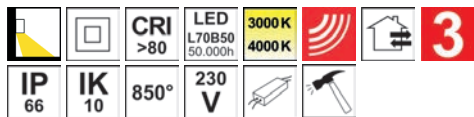

- Applique murale asymétrique pour éclairage intérieur et extérieur.
- 3000K ou 4000K au choix via un interrupteur dans le luminaire.
- Avec détecteur HF 360°, zone de détection réglable max. 10m de diamètre.
- Fonction maître/esclave possible en association avec le LIDY A.
- Avec clé et vis anti-vandale.
- Convertisseur non dimmable intégré dans l'appareil.

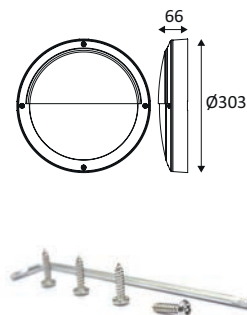

LIDY A SENSOR	COULEUR	MATIÈRE	P	T°	LED LUMEN	SYSTEM LUMEN	€
BU10405	NOIR	POLYCARBONATE	28W	3000K 4000K	4810Lm (4000K)	2930Lm (4000K)	97,00
BU10430	BLANC	POLYCARBONATE	28W	3000K 4000K	4810Lm (4000K)	2930Lm (4000K)	97,00



NOIR



BLANC



HUBLOTS

LIDY A



INDIGO

WL94

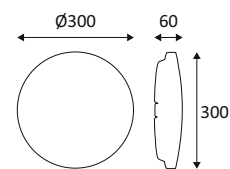
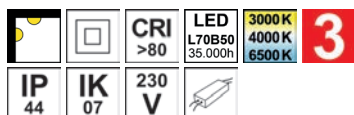

- Applique murale ou plafonnier pour éclairage intérieur.
- 3000K, 4000K ou 6500K au choix via un interrupteur à l'intérieur du luminaire.
- Convertisseur non dimmable intégré dans l'appareil.
- 4 versions disponibles : standard, avec détecteur HF, avec éclairage de secours ou avec détecteur HF & éclairage de secours.



WL94	COULEUR	MATIÈRE	P	T°	LED LUMEN	SYSTEM LUMEN	α	€
STANDARD								
WL9410SCS	BLANC	POLYCARBONATE	10W	3000K 4000K 6500K	1300Lm (4000K)	1100Lm (4000K)	120°	45,00
WL9418SCS	BLANC	POLYCARBONATE	18W	3000K 4000K 6500K	2350Lm (4000K)	2000Lm (4000K)	120°	51,00
DÉTECTEUR HF								
WL9410MCS	BLANC	POLYCARBONATE	10W	3000K 4000K 6500K	1300Lm (4000K)	1100Lm (4000K)	120°	85,00
WL9418MCS	BLANC	POLYCARBONATE	18W	3000K 4000K 6500K	2350Lm (4000K)	2000Lm (4000K)	120°	92,00
ÉCLAIRAGE DE SECOURS								
WL9410ECS	BLANC	POLYCARBONATE	10W	3000K 4000K 6500K	1300Lm (4000K)	1100Lm (4000K)	120°	119,00
DÉTECTEUR HF & ÉCLAIRAGE DE SECOURS								
WL9410CCS	BLANC	POLYCARBONATE	10W	3000K 4000K 6500K	1300Lm (4000K)	1100Lm (4000K)	120°	156,00
WL9418CCS	BLANC	POLYCARBONATE	18W	3000K 4000K 6500K	2350Lm (4000K)	2000Lm (4000K)	120°	162,00





ORKI

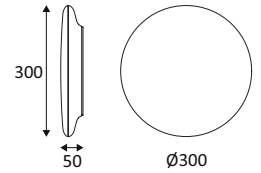
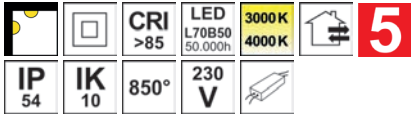

- Applique murale ou plafonnier pour éclairage intérieur et extérieur.
- 3000K ou 4000K au choix via un interrupteur à l'arrière du luminaire.
- Convertisseur non dimmable intégré dans l'appareil.

ORKI	COULEUR	MATIÈRE	P	T°	LED LUMEN	SYSTEM LUMEN	α	€
OU41731	BLANC	POLYCARBONATE	18W	3000K 4000K	2730Lm (4000K)	1770Lm (4000K)	115°	79,00

ORKI SENSOR

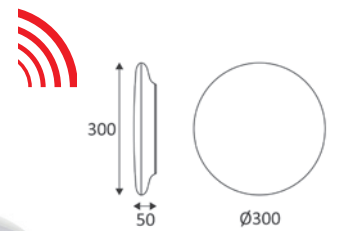
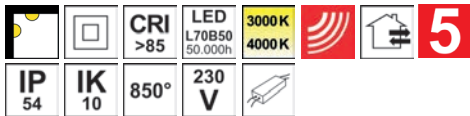

- Applique murale ou plafonnier pour éclairage intérieur et extérieur.
- 3000K ou 4000K au choix via un interrupteur à l'arrière du luminaire.
- Avec détecteur HF 360°, zone de détection réglable max. 10m de diamètre.
- Convertisseur non dimmable intégré dans l'appareil.

ORKI SENSOR	COULEUR	MATIÈRE	P	T°	LED LUMEN	SYSTEM LUMEN	α	€
OU39731	BLANC	POLYCARBONATE	18W	3000K 4000K	2730Lm (4000K)	1770Lm (4000K)	115°	107,00

INDIGO

LIGHTING



RÉGLETTES ÉTANCHES



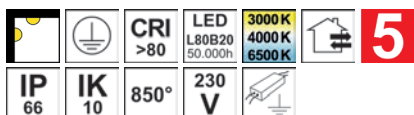

POLAS VERSA

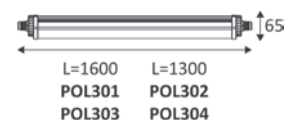

- Luminaire linéaire étanche.
- Diffuseur en polycarbonate.
- 3000K, 4000K ou 6500K au choix via un interrupteur dans le luminaire.
- Avec câblage traversant.
- Convertisseur non dimmable ou dimmable DALI intégré dans l'appareil.
- Clips de montage inclus; étriers et filins de suspension en option.
- Détecteur de mouvement et crépusculaire PIR en option : zone de détection max. 8m de diamètre, hauteur d'installation max. 6m, fonction maître/esclave.



POLAS VERSA	COULEUR	MATIÈRE	P	T°	L(MM)	SYSTEM LUMEN	α	€
NON DIMMABLE								
POL30204	NEW BLANC	POLYCARBONATE	31W	3000K 4000K 6500K	1300	4750Lm (4000K)	120°	50,00
POL30104	NEW BLANC	POLYCARBONATE	43W	3000K 4000K 6500K	1600	6650Lm (4000K)	120°	60,00
DIMMABLE DALI								
POL30404	NEW BLANC	POLYCARBONATE	31W	3000K 4000K 6500K	1300	4750Lm (4000K)	120°	90,00
POL30304	NEW BLANC	POLYCARBONATE	43W	3000K 4000K 6500K	1600	6650Lm (4000K)	120°	100,00
ACCESSOIRES	COULEUR	MATIÈRE	DESCRIPTION			€		
POL306	NEW ACIER INOXYDABLE	INOX	KIT DE SUSPENSION L:3000MM			 10,00		
POL30504	NEW BLANC	POLYCARBONATE	DETECTEUR PIR			 40,00		



- Clips de montage inclus; étriers et filins de suspension en option.
- Détecteur de mouvement et crépusculaire PIR en option.



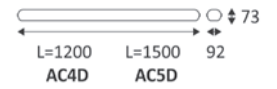

CAIMAN VERSA



- Luminaire linéaire étanche anti-corrosion.
- Diffuseur en polycarbonate anti-UV.
- 3000K, 4000K ou 5700K au choix via un interrupteur dans le luminaire.
- Multi-puissance : 18 ou 37W (AC4) et 28 ou 56W (AC5) au choix via un interrupteur dans le luminaire.
- Convertisseur dimmable DALI-push intégré dans l'appareil.
- Entrées de câble à l'arrière et sur les côtés du luminaire.
- Clips de montage coulissants, étriers pour suspension et presse-étoupe inclus.
- Kits Versabox à connexion rapide en option : détecteur hyperfréquence et commande à distance permettant de paramétrer le détecteur.

CAIMAN VERSA	COULEUR	MATIÈRE	LED	T°	L(MM)	LED LUMEN	SYSTEM LUMEN	α	€
AC4D	NEW GRIS	POLYCARBONATE	18 - 37W	3000K 4000K 5700K	1200	3225 (18W 4000K) 6450 (37W 4000K)	2775 (18W 4000K) 5550 (37W 4000K)	120°	124,00
AC5D	NEW GRIS	POLYCARBONATE	28 - 56W	3000K 4000K 5700K	1500	4850 (28W 4000K) 9700 (56W 4000K)	4200 (28W 4000K) 8400 (56W 4000K)	120°	150,00

ACCESSOIRES	DESCRIPTION	€
ACKITMWS	NEW KIT DETECTEUR HYPERFREQUENCE VERSABOX 	33,00
ACREMOTEMWS	NEW COMMANDE A DISTANCE POUR DETECTEUR HF VERSABOX 	47,00



CAIMAN QUICK CONNECT

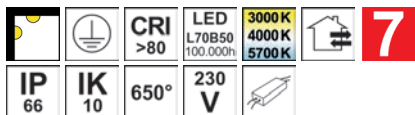

- Luminaire linéaire étanche anti-corrosion.
- Diffuseur en polycarbonate anti-UV.
- 3000K, 4000K ou 5700K au choix via un interrupteur dans le luminaire.
- Multi-puissance : 18 ou 37W (AC4) et 28 ou 56W (AC5) au choix via un interrupteur dans le luminaire.
- Convertisseur non dimmable intégré dans l'appareil.
- Clips de montage coulissants et étriers pour suspension inclus.
- Avec câblage traversant et connexions rapides sans ouverture du luminaire.
- Kit Versabox à connexion rapide en option : détecteur hyperfréquence et commande à distance permettant de paramétrer le détecteur.



CAIMAN QUICK CONNECT	COULEUR	MATIÈRE	LED	T°	L(MM)	LED LUMEN	SYSTEM LUMEN	α	€	
AC4TWN	NEW	GRIS	POLYCARBONATE	18 - 37W	3000K 4000K 5700K	1200	3225 (18W 4000K) 6450 (37W 4000K)	2775 (18W 4000K) 5550 (37W 4000K)	120°	57,00
AC5TWN	NEW	GRIS	POLYCARBONATE	28 - 56W	3000K 4000K 5700K	1500	4850 (28W 4000K) 9700 (56W 4000K)	4200 (28W 4000K) 8400 (56W 4000K)	120°	62,00

ACCESSOIRES	DESCRIPTION	€
ACKITMWS	NEW KIT DETECTEUR HYPERFREQUENCE VERSABOX	33,00
ACREMOTEMWS	NEW COMMANDE A DISTANCE POUR DETECTEUR HF VERSABOX	47,00



CAIMAN QUICK CONNECT



- Installation sans ouverture du luminaire grâce au câblage traversant et aux presse-étoupes Quick Connect.
- Détecteur en option.
- Multi-puissance et multi-CCT.

INDIGO

LIGHTING



HIGH BAY



Guide comparatif des High-Bay

Quelle armature correspond à votre projet ?

Nos armatures sont idéales pour les zones de grandes hauteurs. Utilisez les diagrammes ci-dessous pour choisir le luminaire adapté. La hauteur dont vous disposez et le niveau d'éclairage souhaité (150 ou 200 Lux) vous permettent de déterminer la puissance et la largeur de faisceau du luminaire à sélectionner. Référez-vous aux hauteurs indiquées dans les schémas ci-dessous : chacune précise le diamètre d'éclairage obtenu et vous renseigne l'entraxe optimal entre les luminaires.

EAZY - Aires de stockage au sol (150 Lux)

Une seule référence offre trois niveaux de puissance. Le choix de l'angle du faisceau détermine la référence du luminaire adapté.

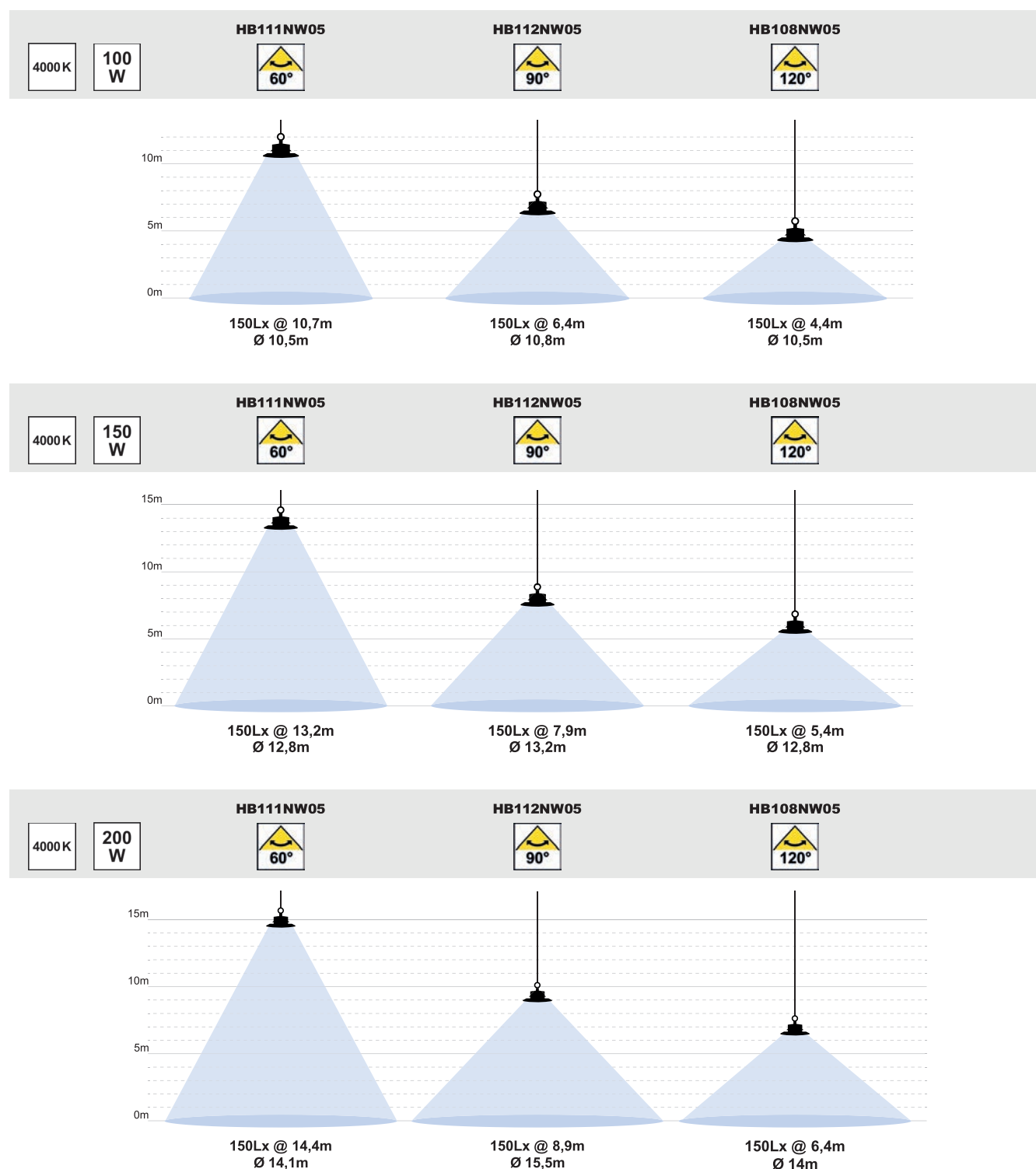



EAZY - Zones de stockages avec racks (200 Lux)

Une seule référence offre trois niveaux de puissance. Le choix de l'angle du faisceau détermine la référence du luminaire adapté.

4000 K	100 W	HB111NW05 	HB112NW05 	HB108NW05
--------	-------	---------------	---------------	---------------

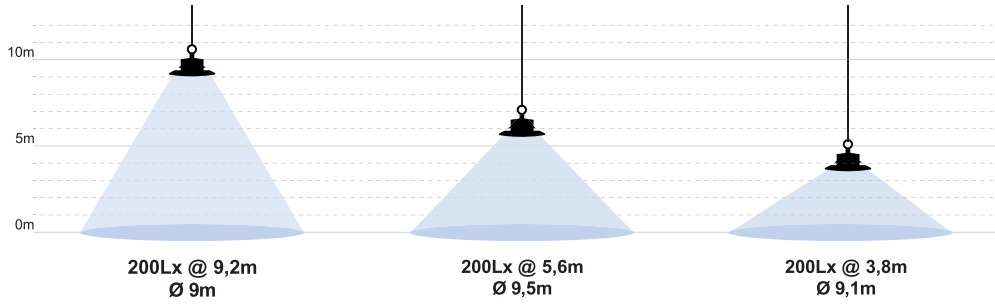

4000 K	150 W	HB111NW05 	HB112NW05 	HB108NW05
--------	-------	---------------	---------------	---------------

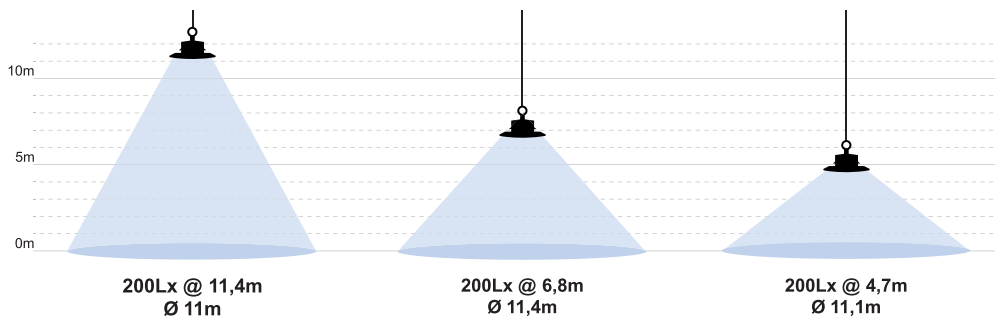

4000 K	200 W	HB111NW05 	HB112NW05 	HB108NW05
--------	-------	---------------	---------------	---------------

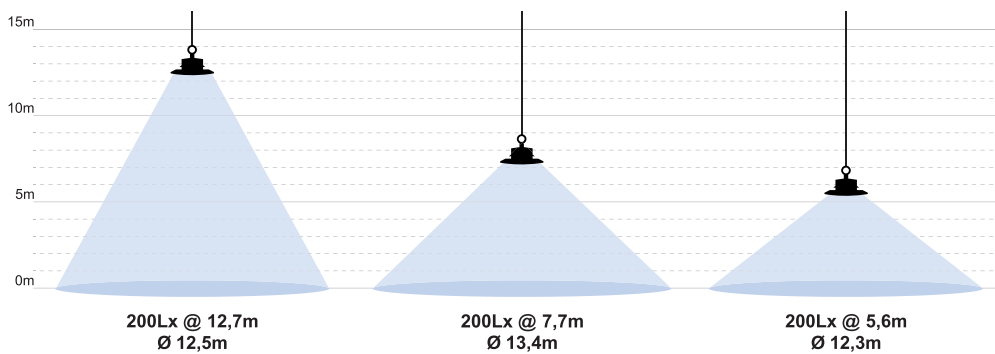

SPRINGBOK - Zones de stockages avec racks (150 Lux)

À l'aide du diagramme ci-dessous, sélectionnez la référence en fonction de la puissance nécessaire à l'éclairage souhaité.

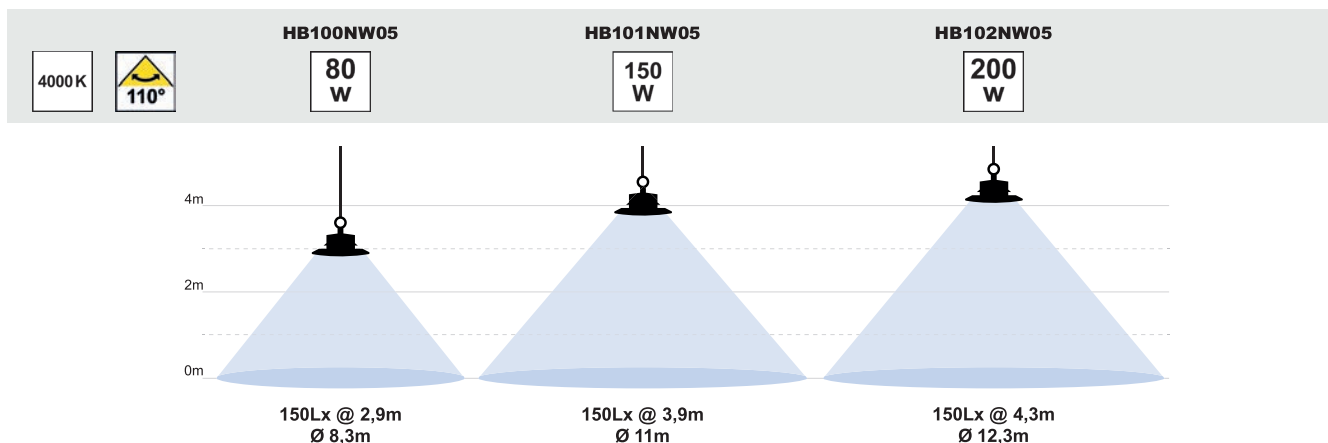

SPRINGBOK - Zones de stockages avec racks (200 Lux)

À l'aide du diagramme ci-dessous, sélectionnez la référence en fonction de la puissance nécessaire à l'éclairage souhaité.

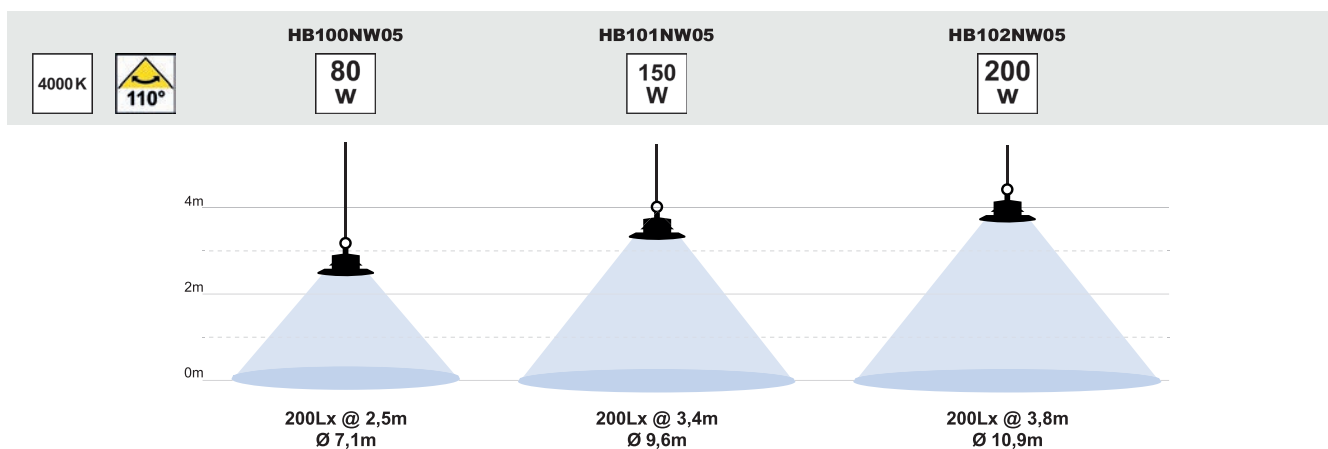



HIGH BAY

SPRINGBOK LITE 3







EAZY

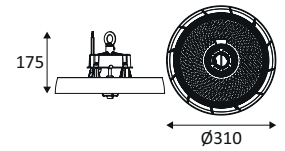
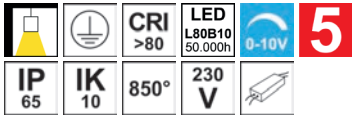

- Suspension industrielle pour grandes hauteurs.
- Diffuseur en polycarbonate.
- Câble d'alimentation H05RN-F noir 1.50m, câble pour variation 0.20m et boucle de suspension M10 inclus.
- Multi-puissance : 100, 150 ou 200W au choix via un interrupteur à l'arrière du luminaire.
- Convertisseur dimmable 0-10V intégré dans l'appareil.
- Installation possible jusqu'à une hauteur de 15m.
- Accessoires en option : étrier de fixation réglable 270°, grille de protection, réflecteur polycarbonate, détecteur hyperfréquence et commande à distance permettant de paramétrer le(s) détecteur(s). L'utilisation du détecteur hyperfréquence n'est pas possible si un variateur 0-10V est raccordé au produit.
- Réglages par défaut du détecteur hyperfréquence : durée d'allumage 10 min., capteur de luminosité 50 Lux, zone de détection 100%, gradation du mode veille 30%, période de veille continue.
- La commande à distance est nécessaire pour paramétrer d'autres réglages.

EAZY	COULEUR	MATIÈRE	LED	T°	LED LUMEN	SYSTEM LUMEN	α	€
HB111WW05	NOIR	FONTE D'ALUMINIUM	100 - 150 - 200W	3000K	19850 (100W) 28900 (150W) 36700 (200W)	15900Lm 22780Lm 29275Lm	60°	211,00
HB111NW05	NOIR	FONTE D'ALUMINIUM	100 - 150 - 200W	4000K	20850 (100W) 30450 (150W) 38650 (200W)	16710Lm 23980Lm 30870Lm	60°	211,00
HB112WW05	NOIR	FONTE D'ALUMINIUM	100 - 150 - 200W	3000K	19850 (100W) 28900 (150W) 36700 (200W)	16395Lm 23535Lm 30275Lm	90°	211,00
HB112NW05	NOIR	FONTE D'ALUMINIUM	100 - 150 - 200W	4000K	20850 (100W) 30450 (150W) 38650 (200W)	17205Lm 24730Lm 31885Lm	90°	211,00
HB108WW05	NOIR	FONTE D'ALUMINIUM	100 - 150 - 200W	3000K	19850 (100W) 28900 (150W) 36700 (200W)	15335Lm 21960Lm 30320Lm	120°	211,00
HB108NW05	NOIR	FONTE D'ALUMINIUM	100 - 150 - 200W	4000K	20850 (100W) 30450 (150W) 38650 (200W)	16920Lm 24480Lm 32075Lm	120°	211,00

ACCESSOIRES	COULEUR	DESCRIPTION	€
HB104	NOIR	ETRIER DE FIXATION REGLABLE 270°	24,00
HB110	BLANC	GRILLE DE PROTECTION	45,00
HB114	NOIR	DETECTEUR HYPERFREQUENCE IP65	61,00
HB115		COMMANDE A DISTANCE POUR DETECTEUR HF	92,00
HB113		REFLECTEUR POLYCARBONATE 412X151MM	63,00

SPRINGBOK LITE 1

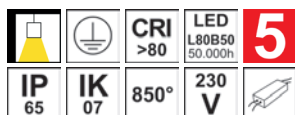

- Suspension industrielle pour grandes hauteurs.
- Diffuseur en verre trempé.
- Câble d'alimentation H05RN-F noir 1.50m et boucle de suspension M10 inclus.
- Convertisseur non dimmable intégré dans l'appareil.
- Installation possible jusqu'à une hauteur de 15m.
- Accessoires en option : étrier de fixation réglable 270°, réflecteur prismatique 80°, détecteur hyperfréquence et commande à distance permettant de paramétrer le(s) détecteur(s).
- Réglages par défaut du détecteur hyperfréquence : durée d'allumage 5 sec., capteur de luminosité désactivé, zone de détection 100%.
- La commande à distance est nécessaire pour paramétrer d'autres réglages.

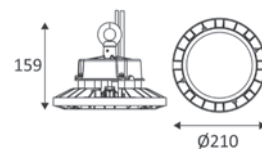

SPRINGBOK LITE 1	COULEUR	MATIÈRE	P	T°	LED LUMEN	SYSTEM LUMEN	α	€
HB100WW05	■ NOIR	FONTE D'ALUMINIUM	80W	3000K	12350Lm	10185Lm	110°	133,00
HB100NW05	■ NOIR	FONTE D'ALUMINIUM	80W	4000K	13150Lm	10545Lm	110°	133,00

ACCESSOIRES	COULEUR	DESCRIPTION	€
HB104	NOIR	ETRIER DE FIXATION REGLABLE 270°	24,00
HB103	NOIR	KIT DETECTEUR HYPERFREQUENCE IP65	146,00
HB115		COMMANDE A DISTANCE POUR DETECTEUR HF	92,00
HB105		REFLECTEUR 80° PC PRISMATIQUE 309X160MM	54,00

SPRINGBOK LITE 2

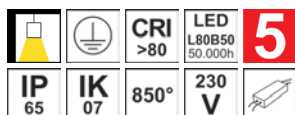

- Suspension industrielle pour grandes hauteurs.
- Diffuseur en verre trempé.
- Câble d'alimentation H05RN-F noir 1.50m et boucle de suspension M10 inclus.
- Convertisseur non dimmable intégré dans l'appareil.
- Installation possible jusqu'à une hauteur de 15m.
- Accessoires en option : étrier de fixation réglable 270°, réflecteur prismatique 80°, détecteur hyperfréquence et commande à distance permettant de paramétrer le(s) détecteur(s).
- Réglages par défaut du détecteur hyperfréquence : durée d'allumage 5 sec., capteur de luminosité désactivé, zone de détection 100%.
- La commande à distance est nécessaire pour paramétrer d'autres réglages.

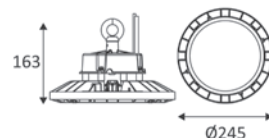

SPRINGBOK LITE 2	COULEUR	MATIÈRE	P	T°	LED LUMEN	SYSTEM LUMEN	α	€
HB101WW05	■ NOIR	FONTE D'ALUMINIUM	150W	3000K	22150Lm	19130Lm	110°	159,00
HB101NW05	■ NOIR	FONTE D'ALUMINIUM	150W	4000K	23550Lm	19525Lm	110°	159,00

ACCESSOIRES	COULEUR	DESCRIPTION	€
HB104	NOIR	ETRIER DE FIXATION REGLABLE 270°	24,00
HB103	NOIR	KIT DETECTEUR HYPERFREQUENCE IP65	146,00
HB115		COMMANDE A DISTANCE POUR DETECTEUR HF	92,00
HB106		REFLECTEUR 80° PC PRISMATIQUE 413X250MM	81,00



SPRINGBOK LITE 3

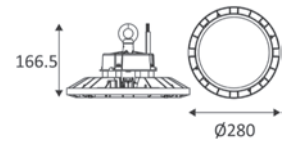
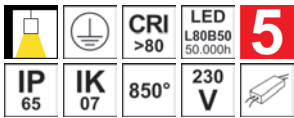

- Suspension industrielle pour grandes hauteurs.
- Diffuseur en verre trempé.
- Câble d'alimentation H05RN-F noir 1.50m et boucle de suspension M10 inclus.
- Convertisseur non dimmable intégré dans l'appareil.
- Installation possible jusqu'à une hauteur de 15m.
- Accessoires en option : étrier de fixation réglable 270°, réflecteur prismatique 80°, détecteur hyperfréquence et commande à distance permettant de paramétrer le(s) détecteur(s).
- Réglages par défaut du détecteur hyperfréquence : durée d'allumage 5 sec., capteur de luminosité désactivé, zone de détection 100%.
- La commande à distance est nécessaire pour paramétrer d'autres réglages.

SPRINGBOK LITE 3	COULEUR	MATIÈRE	P	T°	LED LUMEN	SYSTEM LUMEN	α	€
HB102WW05	NOIR	FONTE D'ALUMINIUM	200W	3000K	29200Lm	25195Lm	110°	184,00
HB102NW05	NOIR	FONTE D'ALUMINIUM	200W	4000K	31050Lm	25715Lm	110°	184,00

ACCESSOIRES	COULEUR	DESCRIPTION	€
HB104	NOIR	ETRIER DE FIXATION REGLABLE 270°	24,00
HB103	NOIR	KIT DETECTEUR HYPERFREQUENCE IP65	146,00
HB115		COMMANDE A DISTANCE POUR DETECTEUR HF	92,00
HB107		REFLECTEUR 80° PC PRISMATIQUE 413X230MM	86,00



LUMINAIRES EXTÉRIEURS



ENCASTRÉS DE SOL

SPOTS SUR PIQUETS

BORNES

ENCASTRÉS MURAUX

APPLIQUES

PLAFONNIERS

PROJECTEURS

SPOTS

SOLAIRES

INDIGO

LIGHTING



ENCASTRÉS DE SOL

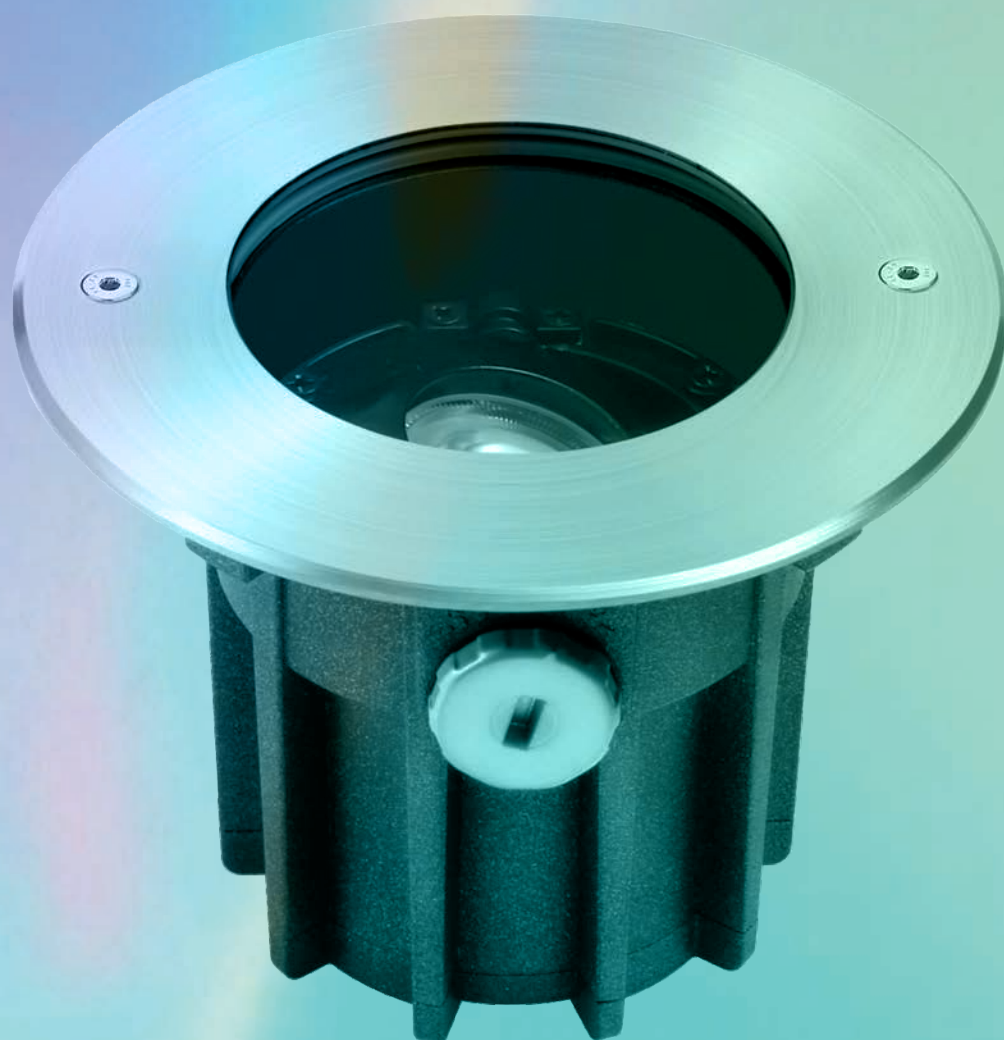

KO2000 R GU10



- Encastré de sol rond.
- Boîtier d'encastrement fourni.
- Système de relamping simple et rapide.
- Carrossable résistance 1000kg.
- Double presse-étoupe.

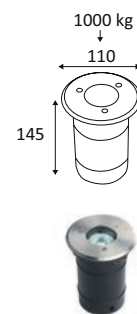

KO2000 R GU10	COULEUR	MATIÈRE	SOQUET	LAMPE	WATT MAX	€	
KO2000R	■	ACIER INOXYDABLE	INOX 304	GU10	PAR16 LED	10W	78,00
KO2000R16	■	ACIER INOXYDABLE	INOX 316	GU10	PAR16 LED	10W	103,00

TINY R



- Encastré de sol rond.
- Diffuseur opalin.
- LED blanche (4000K) ou bleue (BL).
- Carrossable résistance 650kg.
- Boîtier d'encastrement et 1.00m de câble fournis.
- Convertisseur 350mA à commander séparément.

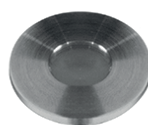

TINY R	COULEUR	MATIÈRE	P	T°	LED LUMEN	SYSTEM LUMEN	α	€	
OU16816	■	ACIER INOXYDABLE	INOX 316	1W	4000K	150Lm	80Lm	120°	70,00
OU26116	■	ACIER INOXYDABLE	INOX 316	1W	BL			120°	70,00

CONVERTISSEURS ET SOURCES		WATT MAX	€
CD114	DRIVER 2-18W 350MA CC IP67	2-18W	41,00



GL018 C

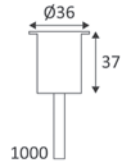
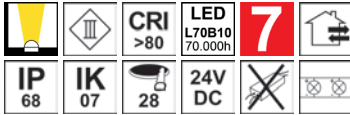

- Encastré de sol rond.
- Diffuseur en verre dépoli.
- 1m de câble H05RN-F fourni (diamètre 6mm).
- Immergeable jusqu'à 9m de profondeur.
- Convertisseur 24Vdc à commander séparément.
- Boîte de raccordement étanche à commander séparément.

GL018 C	COULEUR	MATIÈRE	P	T°	LED LUMEN	SYSTEM LUMEN	α	€	
GL018CWW	■ ACIER INOXYDABLE	INOX 316	0,4W	3000K	30Lm	4Lm	120°	76,00	
ACCESSOIRES	DESCRIPTION	L(MM)	€						
JB1	BOITE DE RACCORDEMENT PARALLELE 3 SORTIES IP68	95							12,00
JB5	BOITE DE CONNEXION PARALLELE AVEC GEL IP68	93,5							49,00
JB6	CONNECTEUR AVEC GEL IP68	40							30,00
CONVERTISSEURS ET SOURCES			WATT MAX	€					
CD178	DRIVER 75W 24V CV IP67		75W	65,00					
CD179	DRIVER 100W 24V CV IP67		100W	110,00					
CD180	DRIVER 150W 24V CV IP67		150W	113,00					
CD181	DRIVER 250W 24V CV IP67		250W	200,00					



PURE 55



- Encastré de sol rond.
- Carrossable résistance 1500kg.
- Boîtier d'encastrement, clips de montage et 1.00m de câble fournis.
- Convertisseur non dimmable intégré dans l'appareil.

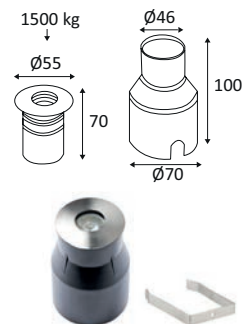

PURE 55	COULEUR	MATIÈRE	P	T°	LED LUMEN	SYSTEM LUMEN	α	€
OU16116	■ ACIER INOXYDABLE	INOX 316	3W	4000K	250Lm	170Lm	24°	139,00



PURE 45

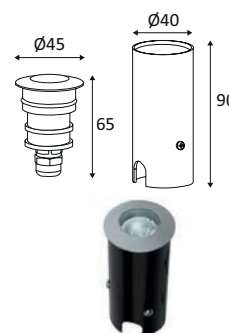

- Encastré de sol rond.
- Boîtier d'encastrement et 0.50m de câble fournis.
- Convertisseur 700mA à commander séparément.



PURE 45	COULEUR	MATIÈRE	P	T°	LED LUMEN	SYSTEM LUMEN	α	€
OU125	■ ALUMINIUM	ALUMINIUM	3W	4000K	200Lm	125Lm	24°	105,00

CONVERTISSEURS ET SOURCES			WATT MAX	€
CD172	DRIVER 2-4W 700MA CC IP65		2-4W	14,00
CD105	DRIVER 9-35W 700MA CC IP67		9-35W	86,00



PURE 55

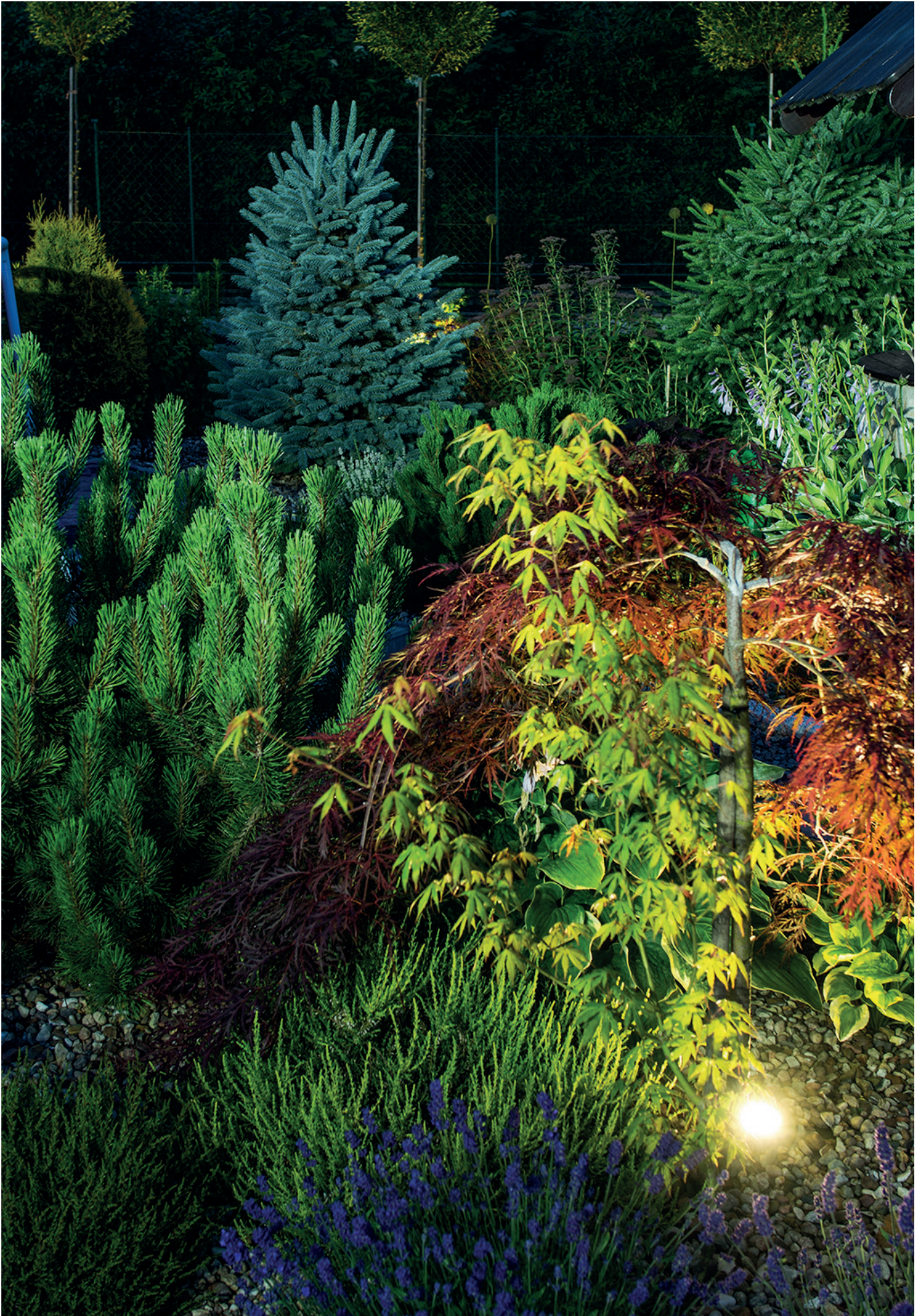

GL019 II



- Encastré de sol rond.
- Diffuseur en verre clair.
- Inox 316 pour les zones côtières.
- Tube d'encastrement et 1m de câble H05RN-F fourni (diamètre 6mm).
- Convertisseur 150 à 700mA à commander séparément.
- Boîte de raccordement étanche à commander séparément.

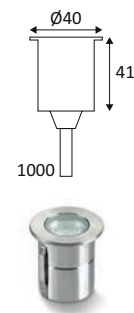

GL019 II	COULEUR	MATIÈRE	LED	T°	LED LUMEN	SYSTEM LUMEN	α	€	
GL019RSS30S	NEW	ACIER INOXYDABLE	INOX 316	0,4 - 2,2W	3000K	290Lm	210Lm	12°	120,00
GL019RSS30F	NEW	ACIER INOXYDABLE	INOX 316	0,4 - 2,2W	3000K	290Lm	210Lm	38°	120,00

ACCESSOIRES	DESCRIPTION	L(MM)	€
JB2	BOITE DE RACCORDEMENT SERIE 3 SORTIES IP68	95	12,00
JB4	BOITE DE CONNEXION SERIE AVEC GEL IP68	93,5	49,00
JB6	CONNECTEUR AVEC GEL IP68	40	30,00

CONVERTISSEURS ET SOURCES	WATT MAX	€
PSIP3509W DRIVER 1-9W 350MA CC IP65	1-9W	48,00
PSIP35018W DRIVER 9-18W 350MA CC IP65	9-18W	63,00
PSIP70018W DRIVER 2-18W 700MA CC IP65	2-18W	62,00
PSIP70036W DRIVER 18-36W 700MA CC IP65	18-36W	81,00
DRV150700 DRIVER 6-30W 150-250-350-500-700MA CC NEW	6-30W	45,00
DRV350700TD DRIVER 14-20W 350-500-700MA CC DIM NEW	14-20W	70,00



GL019 F II

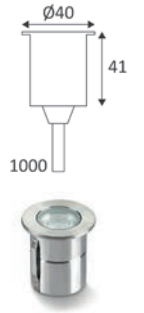
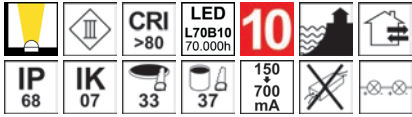

- Encastré de sol rond.
- Diffuseur en verre opalin.
- Inox 316 pour les zones côtières.
- Tube d'encastrement et 1m de câble H05RN-F fourni (diamètre 6mm).
- Convertisseur 150 à 700mA à commander séparément.
- Boîte de raccordement à commander séparément.

GL019 F II	COULEUR	MATIÈRE	LED	T°	LED LUMEN	SYSTEM LUMEN	α	€	
GL019SSFD30	NEW	ACIER INOXYDABLE	INOX 316	0,4 - 2,2W	3000K	290Lm	210Lm	38°	120,00

ACCESSOIRES	DESCRIPTION	L(MM)	€
JB2	BOITE DE RACCORDEMENT SERIE 3 SORTIES IP68	95	12,00
JB4	BOITE DE CONNEXION SERIE AVEC GEL IP68	93,5	49,00
JB6	CONNECTEUR AVEC GEL IP68	40	30,00







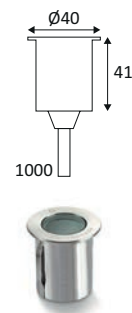

CONVERTISSEURS ET SOURCES	WATT MAX	€
PSIP3509W DRIVER 1-9W 350MA CC IP65	1-9W	48,00
PSIP35018W DRIVER 9-18W 350MA CC IP65	9-18W	63,00
PSIP70018W DRIVER 2-18W 700MA CC IP65	2-18W	62,00
PSIP70036W DRIVER 18-36W 700MA CC IP65	18-36W	81,00
DRV150700 DRIVER 6-30W 150-250-350-500-700MA CC	6-30W	45,00
DRV350700TD DRIVER 14-20W 350-500-700MA CC DIM	14-20W	70,00

GL019 LG II



- Encastré de sol rond.
- Basse luminance, avec grille nid d'abeille.
- Inox 316 pour les zones côtières.
- Tube d'encastrement et 1m de câble H05RN-F fourni (diamètre 6mm).
- Convertisseur 150 à 700mA à commander séparément.
- Boîte de raccordement étanche à commander séparément.



GL019 LG II	COULEUR	MATIÈRE	LED	T°	LED LUMEN	SYSTEM LUMEN	α	€
GL019SSLG30F	NEW ■ ACIER INOXYDABLE	INOX 316	0,4 - 2,2W	3000K	290Lm	210Lm	38°	130,00
ACCESSOIRES	DESCRIPTION	L(MM)						€
JB2	BOITE DE RACCORDEMENT SERIE 3 SORTIES IP68	95						12,00
JB4	BOITE DE CONNEXION SERIE AVEC GEL IP68	93,5						49,00
JB6	CONNECTEUR AVEC GEL IP68	40						30,00
CONVERTISSEURS ET SOURCES		WATT MAX						€
PSIP3509W	DRIVER 1-9W 350MA CC IP65		1-9W	48,00				
PSIP35018W	DRIVER 9-18W 350MA CC IP65		9-18W	63,00				
PSIP70018W	DRIVER 2-18W 700MA CC IP65		2-18W	62,00				
PSIP70036W	DRIVER 18-36W 700MA CC IP65		18-36W	81,00				
DRV150700	DRIVER 6-30W 150-250-350-500-700MA CC NEW		6-30W	45,00				
DRV350700TD	DRIVER 14-20W 350-500-700MA CC DIM NEW		14-20W	70,00				



GL019 ULG II

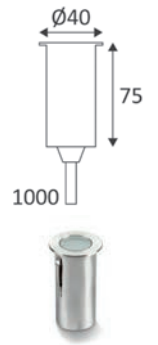
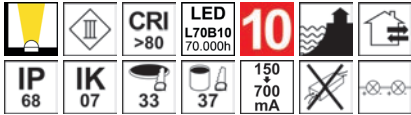

- Encastré de sol rond.
- Très basse luminance.
- Inox 316 pour les zones côtières.
- Tube d'encastrement et 1m de câble H05RN-F fourni (diamètre 6mm).
- Convertisseur 150 à 700mA à commander séparément.
- Boîte de raccordement étanche à commander séparément.





GL019 ULG II	COULEUR	MATIÈRE	LED	T°	LED LUMEN	SYSTEM LUMEN	α	€	
GL019USS30F	NEW	ACIER INOXYDABLE	INOX 316	0,4 - 2,2W	3000K	290Lm	210Lm	36°	160,00
ACCESSOIRES	DESCRIPTION	L(MM)	€						
JB2	BOITE DE RACCORDEMENT SERIE 3 SORTIES IP68	95	12,00						
JB4	BOITE DE CONNEXION SERIE AVEC GEL IP68	93,5	49,00						
JB6	CONNECTEUR AVEC GEL IP68	40	30,00						
CONVERTISSEURS ET SOURCES		WATT MAX	€						
PSIP3509W	DRIVER 1-9W 350MA CC IP65	1-9W	48,00						
PSIP35018W	DRIVER 9-18W 350MA CC IP65	9-18W	63,00						
PSIP70018W	DRIVER 2-18W 700MA CC IP65	2-18W	62,00						
PSIP70036W	DRIVER 18-36W 700MA CC IP65	18-36W	81,00						
DRV150700	DRIVER 6-30W 150-250-350-500-700MA CC NEW	6-30W	45,00						
DRV350700TD	DRIVER 14-20W 350-500-700MA CC DIM NEW	14-20W	70,00						

SWIM

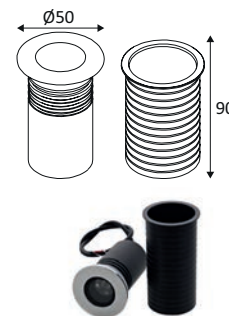

- Encastré de sol rond.
- Boîtier d'encastrement et 0.35m de câble fournis.
- Convertisseur 24Vdc à commander séparément.



SWIM	COULEUR	MATIÈRE	P	T°	LED LUMEN	SYSTEM LUMEN	α	€
OU486WW16	■ ACIER INOXYDABLE	INOX 316	5W	3000K	195Lm	125Lm	24°	79,00
CONVERTISSEURS ET SOURCES			WATT MAX	€				
CD178	DRIVER 75W 24V CV IP67		75W	65,00				
CD179	DRIVER 100W 24V CV IP67		100W	110,00				
CD180	DRIVER 150W 24V CV IP67		150W	113,00				
CD181	DRIVER 250W 24V CV IP67		250W	200,00				





WALLY A



- Encastré de sol rond.
- Wall washer.
- Boîtier d'encastrement et 0.35m de câble fournis.
- Convertisseur 24Vdc à commander séparément.

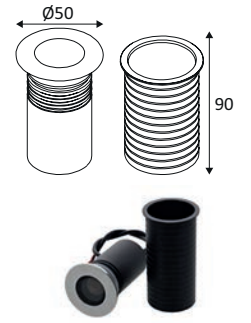

WALLY A	COULEUR	MATIÈRE	P	T°	LED LUMEN	SYSTEM LUMEN	€
OU488WW16	ACIER INOXYDABLE	INOX 316	5W	3000K	195Lm	100Lm	87,00
CONVERTISSEURS ET SOURCES			WATT MAX	€			
CD178	DRIVER 75W 24V CV IP67		75W	65,00			
CD179	DRIVER 100W 24V CV IP67		100W	110,00			
CD180	DRIVER 150W 24V CV IP67		150W	113,00			
CD181	DRIVER 250W 24V CV IP67		250W	200,00			





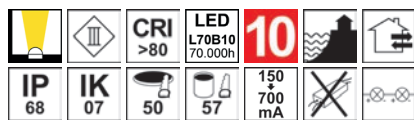



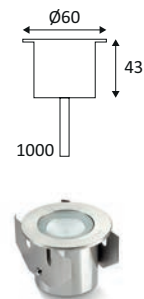



GL016 II



- Encastré de sol rond.
- Diffuseur en verre clair.
- Inox 316 pour les zones côtières.
- Tube d'encastrement et 1m de câble H05RN-F fourni (diamètre 6mm).
- Convertisseur 150 à 700mA à commander séparément.
- Boîte de raccordement étanche à commander séparément.



GL016 II	COULEUR	MATIÈRE	LED	T°	LED LUMEN	SYSTEM LUMEN	α	€
GL016RSS30F	NEW ■ ACIER INOXYDABLE	INOX 316	0,4 - 2,2W	3000K	290Lm	210Lm	40°	130,00
ACCESSOIRES	DESCRIPTION	L(MM)						€
JB2	BOITE DE RACCORDEMENT SERIE 3 SORTIES IP68	95						12,00
JB4	BOITE DE CONNEXION SERIE AVEC GEL IP68	93,5						49,00
JB6	CONNECTEUR AVEC GEL IP68	40						30,00
WCR275BLACK	CABLE H05RN-F 2X0,75MM² 1M	1000						8,00
CONVERTISSEURS ET SOURCES				WATT MAX	€			
PSIP3509W	DRIVER 1-9W 350MA CC IP65			1-9W	48,00			
PSIP35018W	DRIVER 9-18W 350MA CC IP65			9-18W	63,00			
PSIP70018W	DRIVER 2-18W 700MA CC IP65			2-18W	62,00			
PSIP70036W	DRIVER 18-36W 700MA CC IP65			18-36W	81,00			
DRV150700	DRIVER 6-30W 150-250-350-500-700MA CC NEW			6-30W	45,00			
DRV350700TD	DRIVER 14-20W 350-500-700MA CC DIM NEW			14-20W	70,00			



NEW

GL016 F II

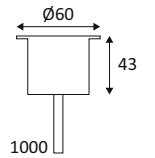
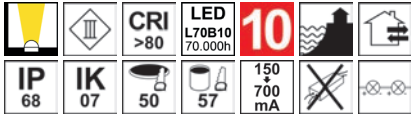

- Encastré de sol rond.
- Diffuseur en verre opalin.
- Inox 316 pour les zones côtières.
- Tube d'encastrement et 1m de câble H05RN-F fourni (diamètre 6mm).
- Convertisseur 150 à 700mA à commander séparément.
- Boîte de raccordement à commander séparément.

GL016 F II	COULEUR	MATIÈRE	LED	T°	LED LUMEN	SYSTEM LUMEN	α	€
GL016SSFD30	NEW ■ ACIER INOXYDABLE	INOX 316	0,4 - 2,2W	3000K	290Lm	210Lm	40°	130,00

ACCESSOIRES	DESCRIPTION	L(MM)	€
JB2	BOITE DE RACCORDEMENT SERIE 3 SORTIES IP68	95	12,00
JB4	BOITE DE CONNEXION SERIE AVEC GEL IP68	93,5	49,00
JB6	CONNECTEUR AVEC GEL IP68	40	30,00
WCR275BLACK	CABLE H05RN-F 2X0,75MM² 1M	1000	8,00

CONVERTISSEURS ET SOURCES	WATT MAX	€
PSIP3509W DRIVER 1-9W 350MA CC IP65	1-9W	48,00
PSIP35018W DRIVER 9-18W 350MA CC IP65	9-18W	63,00
PSIP70018W DRIVER 2-18W 700MA CC IP65	2-18W	62,00
PSIP70036W DRIVER 18-36W 700MA CC IP65	18-36W	81,00
DRV150700 DRIVER 6-30W 150-250-350-500-700MA CC NEW	6-30W	45,00
DRV350700TD DRIVER 14-20W 350-500-700MA CC DIM NEW	14-20W	70,00

PURE 380



- Encastré de sol rond.
- Carrossable résistance 1200kg.
- Boîtier d'encastrement et 0.50m de câble fournis.
- Convertisseur non dimmable intégré dans l'appareil.

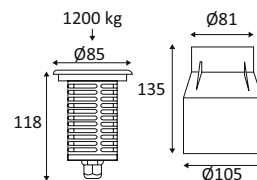

PURE 380	COULEUR	MATIÈRE	P	T°	LED LUMEN	SYSTEM LUMEN	α	€
PU637WW	■ ACIER INOXYDABLE	INOX 316	7W	3000K	760Lm	530Lm	30°	215,00
OU263NW16	■ ACIER INOXYDABLE	INOX 316	7W	4000K	620Lm	485Lm	40°	215,00





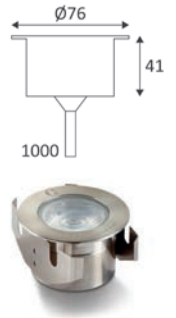
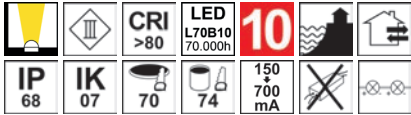

GL040 II



- Encastré de sol rond.
- Diffuseur en verre clair.
- Inox 316 pour les zones côtières.
- Tube d'encastrement et 1m de câble H05RN-F fourni (diamètre 6mm).
- Convertisseur 150 à 700mA à commander séparément.
- Boîte de raccordement étanche à commander séparément.

GL040 II	COULEUR	MATIÈRE	LED	T°	LED LUMEN	SYSTEM LUMEN	α	€	
GL040RSS30S	NEW ■	ACIER INOXYDABLE	INOX 316	0,8 - 4,6W	3000K	620Lm	520Lm	12°	250,00
GL040RSS30F	NEW ■	ACIER INOXYDABLE	INOX 316	0,8 - 4,6W	3000K	620Lm	520Lm	40°	250,00

ACCESSOIRES	DESCRIPTION	L(MM)	€
JB2	BOITE DE RACCORDEMENT SERIE 3 SORTIES IP68	95	 12,00
JB4	BOITE DE CONNEXION SERIE AVEC GEL IP68	93,5	 49,00
JB6	CONNECTEUR AVEC GEL IP68	40	 30,00





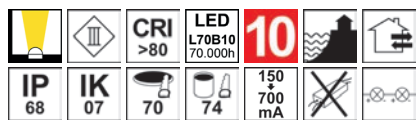

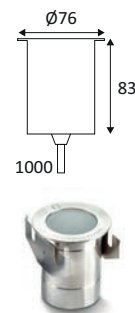

CONVERTISSEURS ET SOURCES	WATT MAX	€
PSIP3509W DRIVER 1-9W 350MA CC IP65	 1-9W	48,00
PSIP35018W DRIVER 9-18W 350MA CC IP65	 9-18W	63,00
PSIP70018W DRIVER 2-18W 700MA CC IP65	 2-18W	62,00
PSIP70036W DRIVER 18-36W 700MA CC IP65	 18-36W	81,00
DRV150700 DRIVER 6-30W 150-250-350-500-700MA CC	 6-30W	NEW 45,00
DRV350700TD DRIVER 14-20W 350-500-700MA CC DIM	 14-20W	NEW 70,00

GL040 ULG II



- Encastré de sol rond.
- Très basse luminance.
- Inox 316 pour les zones côtières.
- Tube d'encastrement et 1m de câble H05RN-F fourni (diamètre 6mm).
- Convertisseur 150 à 700mA à commander séparément.
- Boîte de raccordement étanche à commander séparément.



GL040 ULG II	COULEUR	MATIÈRE	LED	T°	LED LUMEN	SYSTEM LUMEN	α	€
GL040USS30F	NEW ■ ACIER INOXYDABLE	INOX 316	0,8 - 4,6W	3000K	620Lm	520Lm	36°	305,00
ACCESSOIRES	DESCRIPTION	L(MM)						€
JB2	BOITE DE RACCORDEMENT SERIE 3 SORTIES IP68	95						12,00
JB4	BOITE DE CONNEXION SERIE AVEC GEL IP68	93,5						49,00
JB6	CONNECTEUR AVEC GEL IP68	40						30,00
CONVERTISSEURS ET SOURCES		WATT MAX						€
PSIP3509W	DRIVER 1-9W 350MA CC IP65		1-9W	48,00				
PSIP35018W	DRIVER 9-18W 350MA CC IP65		9-18W	63,00				
PSIP70018W	DRIVER 2-18W 700MA CC IP65		2-18W	62,00				
PSIP70036W	DRIVER 18-36W 700MA CC IP65		18-36W	81,00				
DRV150700	DRIVER 6-30W 150-250-350-500-700MA CC NEW		6-30W	45,00				
DRV350700TD	DRIVER 14-20W 350-500-700MA CC DIM NEW		14-20W	70,00				



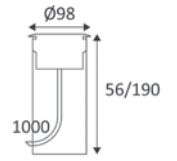
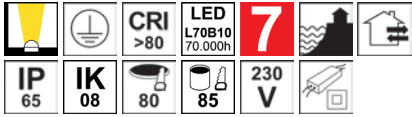

NEW

GL038 II



- Encastré de sol rond.
- Diffuseur en verre clair.
- Inox 316 pour les zones côtières.
- Pot d'encastrement et 1m de câble H05RN-F (diamètre 6mm) fournis.
- Convertisseur non dimmable intégré dans l'appareil.
- Boîte de connexion étanche à commander séparément.

GL038 II	COULEUR	MATIÈRE	P	T°	LED LUMEN	SYSTEM LUMEN	α	€
GL038SS30MF	NEW ■ ACIER INOXYDABLE	INOX 316	2,8W	3000K	620Lm	290Lm	40°	350,00
ACCESSOIRES	DESCRIPTION		L(MM)					€
JB5	BOITE DE CONNEXION PARALLELE AVEC GEL IP68		93,5					49,00
WC59	CONNECTEUR IP68		125					77,00



APA RD-230



- Encastré de sol rond.
- Carrossable résistance 1500kg.
- Avec grille nid d'abeille amovible.
- Boîtier d'encastrement et 1.00m de câble fournis.
- Dimmable.

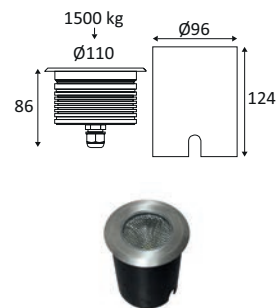

APA RD-230	COULEUR	MATIÈRE	P	T°	LED LUMEN	SYSTEM LUMEN	α	€	
OU326WW16	■	ACIER INOXYDABLE	INOX 316	8W	3000K	550Lm	350Lm	60°	161,00
OU326NW16	■	ACIER INOXYDABLE	INOX 316	8W	4000K	600Lm	405Lm	60°	161,00

BIG APA RD-230



- Encastré de sol rond.
- Carrossable résistance 1500kg.
- Avec grille nid d'abeille amovible.
- Boîtier d'encastrement et 1.00m de câble fournis.
- Dimmable.

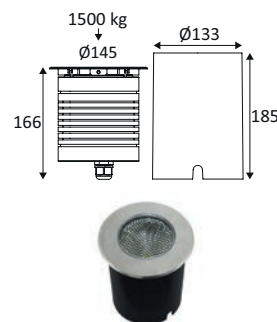

BIG APA RD-230	COULEUR	MATIÈRE	P	T°	LED LUMEN	SYSTEM LUMEN	α	€	
OU411WW16	■	ACIER INOXYDABLE	INOX 316	20W	3000K	1860Lm	1435Lm	60°	255,00
OU411NW16	■	ACIER INOXYDABLE	INOX 316	20W	4000K	1940Lm	1535Lm	60°	255,00



GYRO

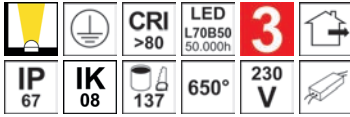

- Encastré de sol rond.
- Boîtier d'encastrement et 1.00m de câble fournis.
- Convertisseur non dimmable intégré dans l'appareil.

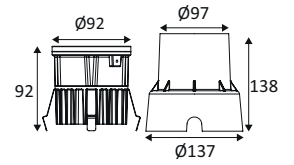

GYRO	COULEUR	MATIÈRE	P	T°	LED LUMEN	SYSTEM LUMEN	α	€
OU425WW05	■ NOIR	VERRE	6W	3000K	500Lm	450Lm	20°	181,00
OU425NW05	■ NOIR	VERRE	6W	4000K	550Lm	490Lm	20°	181,00

GYRO A



- Encastré de sol rond.
- Wall washer.
- Boîtier d'encastrement et 1.00m de câble fournis.
- Convertisseur non dimmable intégré dans l'appareil.

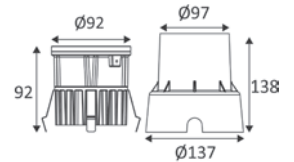

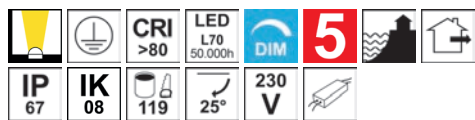

GYRO A	COULEUR	MATIÈRE	P	T°	LED LUMEN	SYSTEM LUMEN	€
OU426WW05	■ NOIR	VERRE	8W	3000K	500Lm	155Lm	181,00
OU426NW05	■ NOIR	VERRE	8W	4000K	550Lm	180Lm	181,00

TILT 1

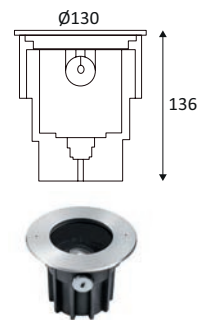

- Encastré de sol rond avec source orientable.
- Diffuseur en verre clair.
- Carrossable résistance 2000kg (max 24km/h).
- Inox 316 pour les zones côtières.
- Pot d'encastrement et 1m de câble H05RN-F (3x1.0mm²) fournis.
- Convertisseur dimmable intégré dans l'appareil.
- Compatible avec variateur début et fin de phase.
- Boîte de connexion étanche à commander séparément.



TILT 1	COULEUR	MATIÈRE	P	T°	LED LUMEN	SYSTEM LUMEN	α	€
GLTMS119T30	NEW ■ ACIER INOXYDABLE	INOX 316	6W	3000K	550Lm	450Lm	34°	221,00
ACCESSOIRES	DESCRIPTION	L(MM)						€
JB5	BOITE DE CONNEXION PARALLELE AVEC GEL IP68	93,5						49,00
WC59	CONNECTEUR IP68	125						77,00

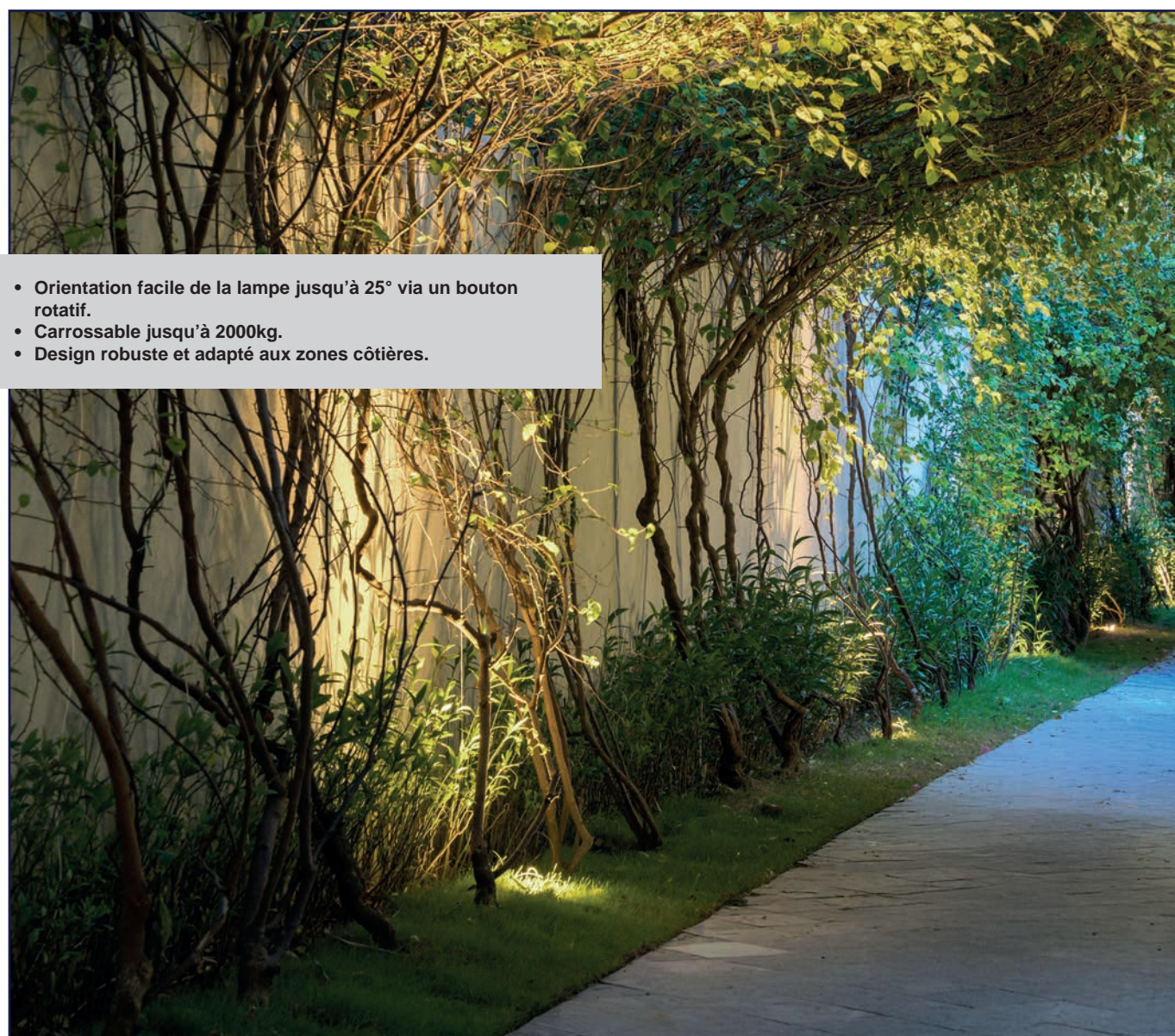

- Orientation facile de la lampe jusqu'à 25° via un bouton rotatif.
- Carrossable jusqu'à 2000kg.
- Design robuste et adapté aux zones côtières.





TILT 2

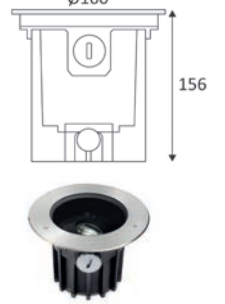

- Encastré de sol rond avec source orientable.
- Diffuseur en verre clair.
- Carrossable résistance 2000kg (max 24km/h).
- Inox 316 pour les zones côtières.
- Pot d'encastrement et 1m de câble H05RN-F (3x1.0mm²) fournis.
- Convertisseur dimmable intégré dans l'appareil.
- Compatible avec variateur début et fin de phase.
- Boîte de connexion étanche à commander séparément.



NEW

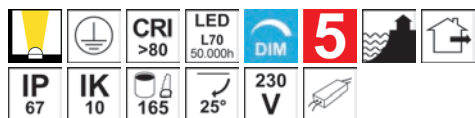

TILT 2	COULEUR	MATIÈRE	P	T°	LED LUMEN	SYSTEM LUMEN	α	€	
GLTMS147T30	NEW ■ ACIER INOXYDABLE	INOX 316	12W	3000K	1400Lm	1200Lm	34°	282,00	
ACCESSOIRES	DESCRIPTION	L(MM)	€						
JB5	BOITE DE CONNEXION PARALLELE AVEC GEL IP68	93,5							49,00
WC59	CONNECTEUR IP68	125							77,00

TILT 3

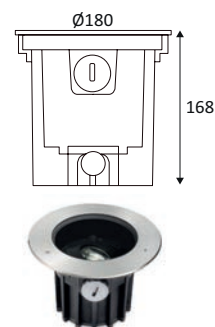

- Encastré de sol rond avec source orientable.
- Diffuseur en verre clair.
- Carrossable résistance 2000kg (max 24km/h).
- Inox 316 pour les zones côtières.
- Pot d'encastrement et 1m de câble H05RN-F (3x1.0mm²) fournis.
- Convertisseur dimmable intégré dans l'appareil.
- Compatible avec variateur début et fin de phase.
- Boîte de connexion étanche à commander séparément.



TILT 3	COULEUR	MATIÈRE	P	T°	LED LUMEN	SYSTEM LUMEN	α	€
GLTMS165T30	NEW  ACIER INOXYDABLE	INOX 316	18W	3000K	2000Lm	1600Lm	34°	412,00
ACCESSOIRES	DESCRIPTION	L(MM)						€
JB5	BOITE DE CONNEXION PARALLELE AVEC GEL IP68	93,5						49,00
WC59	CONNECTEUR IP68	125						77,00



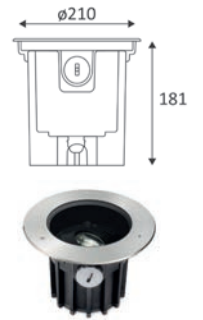
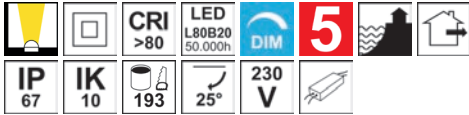

TILT 4



NEW



- Encastré de sol rond avec source orientable.
- Diffuseur en verre clair.
- Carrossable résistance 2000kg (max 24km/h).
- Inox 316 pour les zones côtières.
- Pot d'encastrement et 1m de câble H05RN-F (3x1.0mm²) fournis.
- Convertisseur dimmable intégré dans l'appareil.
- Compatible avec variateur début et fin de phase.
- Boîte de connexion étanche à commander séparément.

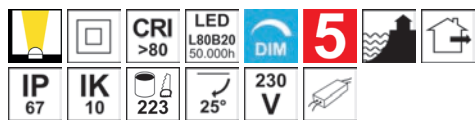

TILT 4	COULEUR	MATIÈRE	P	T°	LED LUMEN	SYSTEM LUMEN	α	€
GLTMS193T30	NEW ■ ACIER INOXYDABLE	INOX 316	23W	3000K	3000Lm	2300Lm	34°	800,00
ACCESSOIRES	DESCRIPTION	L(MM)						€
JB5	BOITE DE CONNEXION PARALLELE AVEC GEL IP68	93,5						49,00
WC59	CONNECTEUR IP68	125						77,00

TILT 5

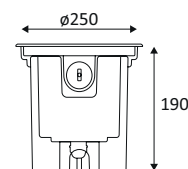

- Encastré de sol rond avec source orientable.
- Diffuseur en verre clair.
- Carrossable résistance 2000kg (max 24km/h).
- Inox 316 pour les zones côtières.
- Pot d'encastrement et 1m de câble H05RN-F (3x1.0mm²) fournis.
- Convertisseur dimmable intégré dans l'appareil.
- Compatible avec variateur début et fin de phase.
- Boîte de connexion étanche à commander séparément.



TILT 5	COULEUR	MATIÈRE	P	T°	LED LUMEN	SYSTEM LUMEN	α	€
GLTMS223T30	NEW ■ ACIER INOXYDABLE	INOX 316	30W	3000K	4000Lm	3300Lm	34°	1000,00
ACCESSOIRES	DESCRIPTION	L(MM)						€
JB5	BOITE DE CONNEXION PARALLELE AVEC GEL IP68	93,5						49,00
WC59	CONNECTEUR IP68	125						77,00



RODI A

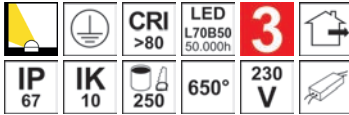

- Encastré de sol rond.
- Wall washer.
- Carrossable résistance 2000kg.
- Boîtier d'encastrement et 2.00m de câble fournis.
- Convertisseur non dimmable intégré dans l'appareil.



RODI A	COULEUR	MATIÈRE	P	T°	LED LUMEN	SYSTEM LUMEN	€
OU427WW16	■ ACIER INOXYDABLE	INOX 316	20W	3000K	2100Lm	1610Lm	589,00

BIG RODI A

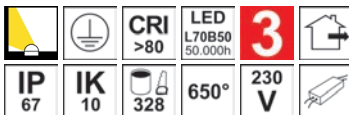

- Encastré de sol rond.
- Wall washer.
- Carrossable résistance 2000kg.
- Boîtier d'encastrement et 2.00m de câble fournis.
- Convertisseur non dimmable intégré dans l'appareil.

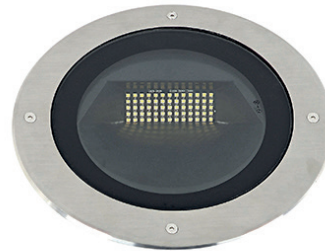

BIG RODI A	COULEUR	MATIÈRE	P	T°	LED LUMEN	SYSTEM LUMEN	€
OU428WW16	■ ACIER INOXYDABLE	INOX 316	30W	3000K	2800Lm	2635Lm	703,00

GL100 II

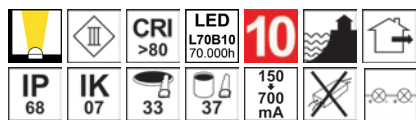

- Semi-encastré de sol rond pour balisage.
- Diffusion de la lumière dans une, deux, trois ou quatre directions.
- Inox 316 pour les zones côtières.
- Tube d'encastrement et 1m de câble H05RN-F fourni (diamètre 6mm).
- Immergeable jusqu'à 9m de profondeur.
- Convertisseur 150 à 700mA à commander séparément.
- Boîte de raccordement étanche à commander séparément.

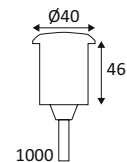

GL100 II	COULEUR	MATIÈRE	LED	T°	LED LUMEN	SYSTEM LUMEN	α	€
1 FENÊTRE								
GL100SS1W30	NEW	ACIER INOXYDABLE	INOX 316	0,4 - 2,2W	3000K	290Lm	6Lm	75° 180,00
2 FENÊTRES / 1 DIRECTION								
GL100SS2W30	NEW	ACIER INOXYDABLE	INOX 316	0,4 - 2,2W	3000K	290Lm	11Lm	75° 180,00
2 FENÊTRES / 2 DIRECTIONS								
GL100SS2O30	NEW	ACIER INOXYDABLE	INOX 316	0,4 - 2,2W	3000K	290Lm	11Lm	75° 180,00
3 FENÊTRES								
GL100SS3W30	NEW	ACIER INOXYDABLE	INOX 316	0,4 - 2,2W	3000K	290Lm	16Lm	75° 180,00
4 FENÊTRES								
GL100SS4W30	NEW	ACIER INOXYDABLE	INOX 316	0,4 - 2,2W	3000K	290Lm	20Lm	75° 180,00

ACCESSOIRES	DESCRIPTION	L(MM)	€
JB2	BOITE DE RACCORDEMENT SERIE 3 SORTIES IP68	95	12,00
JB4	BOITE DE CONNEXION SERIE AVEC GEL IP68	93,5	49,00
JB6	CONNECTEUR AVEC GEL IP68	40	30,00

CONVERTISSEURS ET SOURCES		WATT MAX	€
PSIP3509W	DRIVER 1-9W 350MA CC IP65	1-9W	48,00
PSIP35018W	DRIVER 9-18W 350MA CC IP65	9-18W	63,00
PSIP70018W	DRIVER 2-18W 700MA CC IP65	2-18W	62,00
PSIP70036W	DRIVER 18-36W 700MA CC IP65	18-36W	81,00
DRV150700	DRIVER 6-30W 150-250-350-500-700MA CC NEW	6-30W	45,00
DRV350700TD	DRIVER 14-20W 350-500-700MA CC DIM NEW	14-20W	70,00





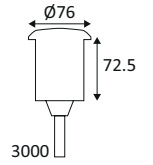
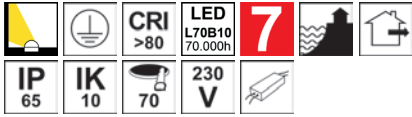

GL200



- Semi-encastré de sol rond pour balisage.
- Diffusion de la lumière dans une, deux, trois ou quatre directions.
- Inox 316 pour les zones côtières.
- 3m de câble H05RN-F fourni (diamètre 7mm).
- Convertisseur non dimmable intégré dans l'appareil.
- Tube d'encastrément et boîte de raccordement étanche à commander séparément.



GL200	COULEUR	MATIÈRE	P	T°	LED LUMEN	SYSTEM LUMEN	α	€	
1 FENÊTRE									
GL200DX1X30	■	ACIER INOXYDABLE	INOX 316	5,7W	3000K	270Lm	10Lm	90°	266,00
2 FENÊTRES / 1 DIRECTION									
GL200DX2130	■	ACIER INOXYDABLE	INOX 316	5,7W	3000K	270Lm	20Lm	90°	271,00
2 FENÊTRES / 2 DIRECTIONS									
GL200DX2230	■	ACIER INOXYDABLE	INOX 316	5,7W	3000K	270Lm	20Lm	90°	271,00
3 FENÊTRES									
GL200DX3X30	■	ACIER INOXYDABLE	INOX 316	5,7W	3000K	270Lm	30Lm	90°	277,00
4 FENÊTRES									
GL200DX4X30	■	ACIER INOXYDABLE	INOX 316	5,7W	3000K	270Lm	40Lm	90°	284,00
ACCESSOIRES	MATIÈRE	DESCRIPTION			L(MM)			€	
TUBE68	ALUMINIUM	TUBE D'ENCASTREMENT 72X150MM						43,00	
JB5		BOITE DE CONNEXION PARALLELE AVEC GEL IP68			93,5			49,00	
WC59		CONNECTEUR IP68			125			77,00	

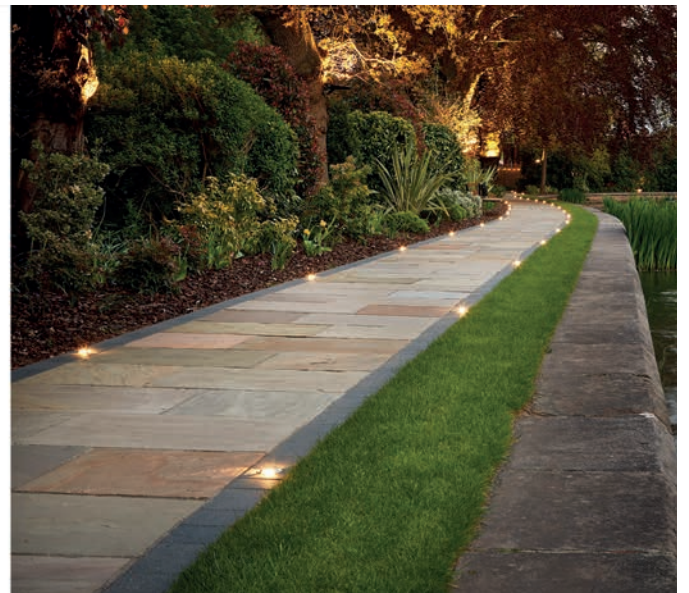

INDIGO

LIGHTING



SPOTS SUR PIQUETS



LUXI 65 GU10

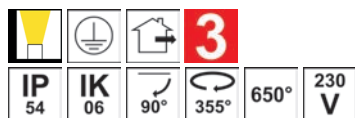

- Spot d'accentuation pour éclairage extérieur.
- Câble 2.00m et piquet à enterrer inclus.



LUXI 65 GU10	COULEUR	MATIÈRE	SOQUET	LAMPE	WATT MAX	€
OU10824	■ ANTHRACITE	FONTE D'ALUMINIUM	GU10	PAR16 LED	11W	67,00
ACCESSOIRES	DESCRIPTION					€
OU48405	CONNECTEUR 2PIN IP68					11,00
OU48505	CONNECTEUR 3PIN IP68					30,00







TURA GU10



- Spot d'accentuation pour éclairage extérieur.
- Câble 2.00m et piquet à enterrer inclus.



TURA GU10	COULEUR	MATIÈRE	SOQUET	LAMPE	WATT MAX	€
OU43624	■ ANTHRACITE	FONTE D'ALUMINIUM	GU10	PAR16 LED	11W	63,00
ACCESSOIRES	DESCRIPTION					€
OU48405	CONNECTEUR 2PIN IP68					11,00
OU48505	CONNECTEUR 3PIN IP68					30,00



OLA 1

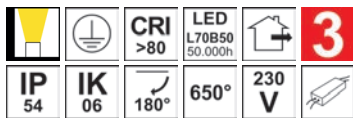

- Spot d'accentuation pour éclairage extérieur.
- Câble 0.30m et piquet à enterrer inclus.
- Convertisseur non dimmable intégré dans l'appareil.
- Accessoire inclus : plaque occultante amovible.

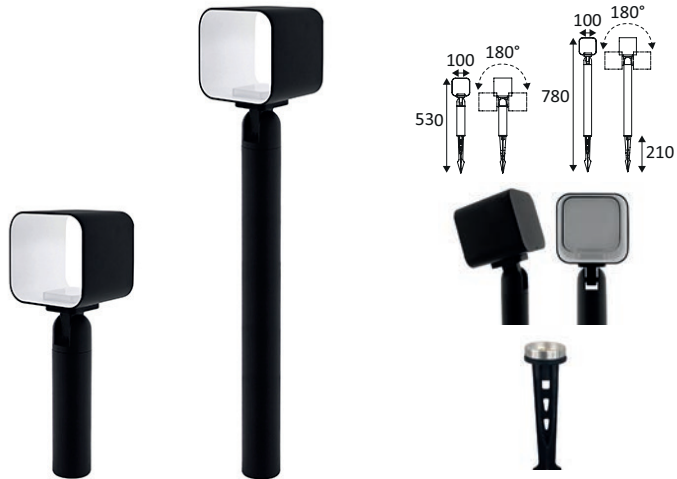

OLA 1	COULEUR	MATIÈRE	P	T°	H(MM)	LED LUMEN	SYSTEM LUMEN	€
OU482WW05	■ NOIR MAT	ALUMINIUM	3W	3000K	320	420Lm	230Lm	117,00
OU483WW05	■ NOIR MAT	ALUMINIUM	3W	3000K	570	420Lm	230Lm	124,00

ACCESSOIRES	DESCRIPTION	€
OU48405	CONNECTEUR 2PIN IP68	11,00
OU48505	CONNECTEUR 3PIN IP68	30,00



DANS LA MÊME GAMME



OLA 2 PAGE 448





SL040A

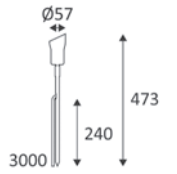
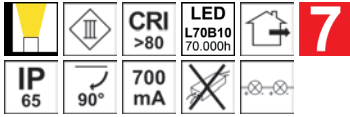

- Spot d'accentuation pour éclairage extérieur.
- Avec visière basse luminance.
- Câble H05RN-F 3.00m (diamètre 6mm) et piquet à enterrer inclus.
- Convertisseur 700mA à commander séparément.
- Boîte de raccordement étanche à commander séparément.

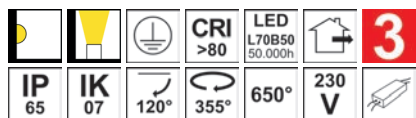

SL040A	COULEUR	MATIÈRE	P	T°	SYSTEM LUMEN	α	€
SL040AFWW	■ NOIR	ALUMINIUM	7W	3000K	413Lm	38°	219,00
ACCESSOIRES	DESCRIPTION	L(MM)					€
JB2	BOITE DE RACCORDEMENT SERIE 3 SORTIES IP68	95					12,00
JB4	BOITE DE CONNEXION SERIE AVEC GEL IP68	93,5					49,00
JB6	CONNECTEUR AVEC GEL IP68	40					30,00
WCR275BLACK	CABLE H05RN-F 2X0,75MM² 1M	1000					8,00
CONVERTISSEURS ET SOURCES			WATT MAX			€	
PSIP70018W	DRIVER 2-18W 700MA CC IP65		2-18W			62,00	
PSIP70036W	DRIVER 18-36W 700MA CC IP65		18-36W			81,00	

RIESA

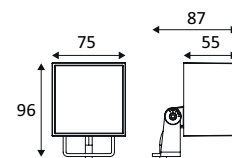

- Spot d'accentuation pour éclairage extérieur.
- Câble 1.50m et piquet à enterrer inclus.
- Convertisseur non dimmable intégré dans l'appareil.



RIESA	COULEUR	MATIÈRE	P	T°	LED LUMEN	SYSTEM LUMEN	α	€
OU461WW24	■ ANTHRACITE	FONTE D'ALUMINIUM	6W	3000K	550Lm	400Lm	30°	115,00
ACCESSOIRES	COULEUR	DESCRIPTION			L(MM)			€
OU48405		CONNECTEUR 2PIN IP68						11,00
OU48505		CONNECTEUR 3PIN IP68						30,00
OU46224	ANTHRACITE	VISIERE			75			13,00





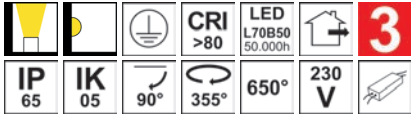

BRAMA 1

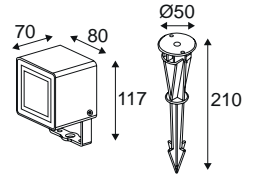

- Spot d'accentuation pour éclairage extérieur.
- Câble 1.50m et piquet à enterrer inclus.
- Double presse-étoupe.
- Convertisseur non dimmable intégré dans l'appareil.



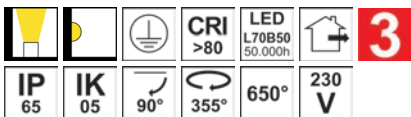

BRAMA 1	COULEUR	MATIÈRE	P	T°	LED LUMEN	SYSTEM LUMEN	α	€
OU345WW24	■ ANTHRACITE	FONTE D'ALUMINIUM	7W	3000K	1000Lm	595Lm	40°	155,00
ACCESSOIRES	DESCRIPTION							€
OU48405	CONNECTEUR 2PIN IP68							11,00
OU48505	CONNECTEUR 3PIN IP68							30,00

BRAMA 2

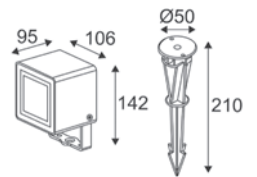

- Spot d'accentuation pour éclairage extérieur.
- Câble 1.50m et piquet à enterrer inclus.
- Double presse-étoupe.
- Ne nécessite pas de convertisseur.
- Non dimmable.



BRAMA 2	COULEUR	MATIÈRE	P	T°	LED LUMEN	SYSTEM LUMEN	α	€
OU346WW24	■ ANTHRACITE	FONTE D'ALUMINIUM	20W	3000K	1800Lm	1565Lm	30°	208,00
ACCESSOIRES	DESCRIPTION							€
OU48405	CONNECTEUR 2PIN IP68							11,00
OU48505	CONNECTEUR 3PIN IP68							30,00

BASIL 1 P

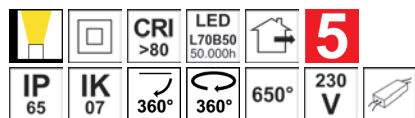

- Spot d'accentuation pour éclairage extérieur.
- Hauteur de tige réglable : 60 ou 90cm.
- Disposition du spot ajustable.
- Câble 2.50m et piquet à enterrer inclus.
- Convertisseur non dimmable intégré dans l'appareil.

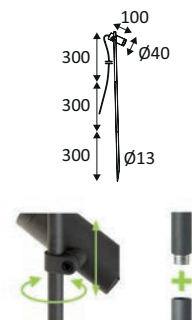

BASIL 1 P	COULEUR	MATIÈRE	P	T°	LED LUMEN	SYSTEM LUMEN	α	€
OU517WW05	■ NOIR MAT	ALUMINIUM	4W	3000K	475Lm	295Lm	50°	141,00
ACCESSOIRES	DESCRIPTION							€
OU48405	CONNECTEUR 2PIN IP68							11,00
OU48505	CONNECTEUR 3PIN IP68							30,00

BASIL 2 P

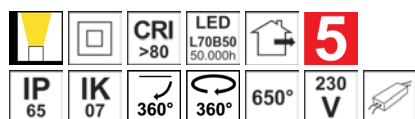

- Spot d'accentuation pour éclairage extérieur.
- Hauteur de tige réglable : 60 ou 90cm.
- Disposition des spots ajustable.
- Câble 2.50m et piquet à enterrer inclus.
- Convertisseurs non dimmables intégrés dans l'appareil.

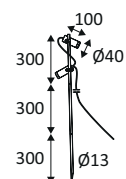

BASIL 2 P	COULEUR	MATIÈRE	P	T°	LED LUMEN	SYSTEM LUMEN	α	€
OU518WW05	■ NOIR MAT	ALUMINIUM	8W	3000K	2x475Lm	590Lm	50°	211,00
ACCESSOIRES	DESCRIPTION							€
OU48405	CONNECTEUR 2PIN IP68							11,00
OU48505	CONNECTEUR 3PIN IP68							30,00



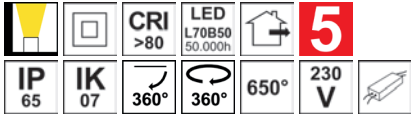

BASIL 3 P

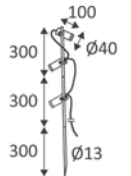

- Spot d'accentuation pour éclairage extérieur.
- Hauteur de tige réglable : 60 ou 90cm.
- Disposition des spots ajustable.
- Câble 2.50m et piquet à enterrer inclus.
- Convertisseurs non dimmables intégrés dans l'appareil.



BASIL 3 P	COULEUR	MATIÈRE	P	T°	LED LUMEN	SYSTEM LUMEN	α	€
OU519WW05	■ NOIR MAT	ALUMINIUM	12W	3000K	3x475Lm	885Lm	50°	280,00
ACCESSOIRES	DESCRIPTION							€
OU48405	CONNECTEUR 2PIN IP68							11,00
OU48505	CONNECTEUR 3PIN IP68							30,00



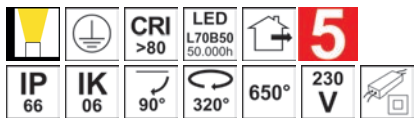

SPOTTY 1 P

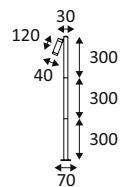

- Spot d'accentuation pour éclairage extérieur.
- Hauteur de tige réglable : 30, 60 ou 90cm.
- Piquet à enterrer ou base de fixation et kit d'ancrage à commander séparément.
- Convertisseur non dimmable intégré dans l'appareil.



SPOTTY 1 P	COULEUR	MATIÈRE	P	T°	LED LUMEN	SYSTEM LUMEN	α	€
PT090/01/M/3K/A	NEW ANTHRACITE	ALUMINIUM	6W	3000K	600Lm	400Lm	30°	250,00
ACCESSOIRES	COULEUR	MATIÈRE	DESCRIPTION					€
PT090/BASE/A	NEW ANTHRACITE	ALUMINIUM + THERMOPLASTIQUE	BASE DE FIXATION 160MM					80,00
PT090/SPIKE/A	NEW ANTHRACITE	ALUMINIUM	PIQUET A ENTERRER					25,00
KIT/PT090	NEW	ACIER	KIT D'ANCRAGE					50,00

DANS LA MÊME GAMME



SPOTTY 2 W PAGE 477



SPOTTY 3 W PAGE 477



SPOTTY 1 W PAGE 476





SPOTTY 2 P

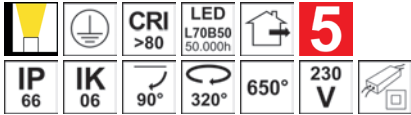

- Spot d'accentuation pour éclairage extérieur.
- Hauteur de tige réglable : 30, 60 ou 90cm.
- Piquet à enterrer ou base de fixation et kit d'ancrage à commander séparément.
- Convertisseur non dimmable intégré dans l'appareil.

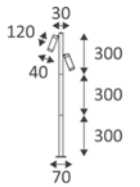

NEW

SPOTTY 2 P	COULEUR	MATIÈRE	P	T°	LED LUMEN	SYSTEM LUMEN	α	€
PT090/02/M/3K/A	NEW ANTHRACITE	ALUMINIUM	11,5W	3000K	2x600Lm	800Lm	30°	350,00
ACCESSOIRES	COULEUR	MATIÈRE	DESCRIPTION					€
PT090/BASE/A	NEW ANTHRACITE	ALUMINIUM + THERMOPLASTIQUE	BASE DE FIXATION 160MM					80,00
PT090/SPIKE/A	NEW ANTHRACITE	ALUMINIUM	PIQUET A ENTERRER					25,00
KIT/PT090	NEW	ACIER	KIT D'ANCRAGE					50,00

DANS LA MÊME GAMME



SPOTTY 1 W PAGE 476



SPOTTY 2 W PAGE 477



SPOTTY 3 W PAGE 477



GUNZY

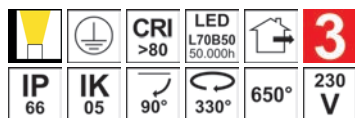

- Spot d'accentuation pour éclairage extérieur.
- Câble 2.00m et piquet à enterrer en acier inoxydable inclus.
- Ne nécessite pas de convertisseur.
- Non dimmable.

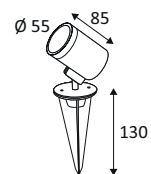

GUNZY	COULEUR	MATIÈRE	P	T°	LED LUMEN	SYSTEM LUMEN	α	€
OU458WW24	■ ANTHRACITE	FONTE D'ALUMINIUM	8W	3000K	760Lm	465Lm	38°	175,00

ACCESSOIRES	DESCRIPTION	€
OU48405	CONNECTEUR 2PIN IP68	11,00
OU48505	CONNECTEUR 3PIN IP68	30,00

DANS LA MÊME GAMME



GUNZY S PAGE 478



GUNZY 2 S PAGE 478





GUNZY P

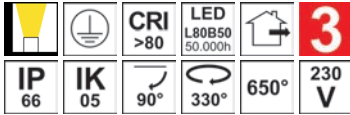

- Spot d'accentuation pour éclairage extérieur.
- Câble 2.50m et piquet à enterrer inclus.
- Ne nécessite pas de convertisseur.
- Non dimmable.

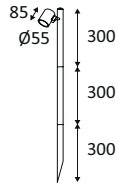

GUNZY P	COULEUR	MATIÈRE	P	T°	LED LUMEN	SYSTEM LUMEN	α	€
OU18724	■ ANTHRACITE	FONTE D'ALUMINIUM	8W	3000K	760Lm	465Lm	38°	221,00

ACCESSOIRES	DESCRIPTION	€
OU48405	CONNECTEUR 2PIN IP68	11,00
OU48505	CONNECTEUR 3PIN IP68	30,00

DANS LA MÊME GAMME



GUNZY S PAGE 478



GUNZY 2 S PAGE 478



GUNZY 2 P

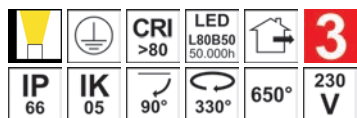

- Spot d'accentuation pour éclairage extérieur.
- Câble 2.50m et piquet à enterrer inclus.
- Ne nécessite pas de convertisseur.
- Non dimmable.

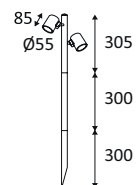

GUNZY 2 P	COULEUR	MATIÈRE	P	T°	LED LUMEN	SYSTEM LUMEN	α	€
OU457WW24	ANTHRACITE	FONTE D'ALUMINIUM	16W	3000K	2x760Lm	925Lm	38°	303,00

ACCESSOIRES	DESCRIPTION	€
OU48405	CONNECTEUR 2PIN IP68	11,00
OU48505	CONNECTEUR 3PIN IP68	30,00

DANS LA MÊME GAMME



GUNZY 2 S PAGE 478



GUNZY S PAGE 478





YUKA

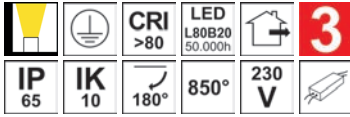

- Spot d'accentuation pour éclairage extérieur.
- Câble 0.60m, boîtier de connexion et piquet à enterrer inclus.
- Convertisseur non dimmable intégré dans l'appareil.

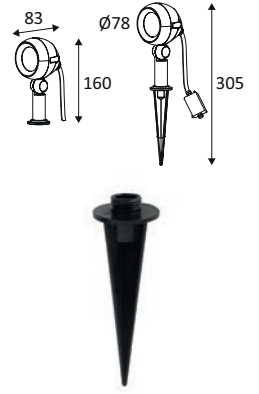

YUKA	COULEUR	MATIÈRE	P	T°	LED LUMEN	SYSTEM LUMEN	α	€
OU497WW05	■ NOIR MAT	ALUMINIUM	8W	3000K	1100Lm	835Lm	60°	94,00

ANDY



- Spot d'accentuation pour éclairage extérieur.
- Câble 1.50m, boîtier de connexion et piquet à enterrer inclus.
- Ne nécessite pas de convertisseur.
- Non dimmable.



ANDY	COULEUR	MATIÈRE	P	T°	H(MM)	LED LUMEN	SYSTEM LUMEN	α	€
OU465WW24	■ ANTHRACITE	FONTE D'ALUMINIUM	15W	3000K	210	1490Lm	985Lm	40°	160,00
OU466WW24	■ ANTHRACITE	FONTE D'ALUMINIUM	15W	3000K	520	1490Lm	985Lm	40°	174,00

SL220 MAINS II

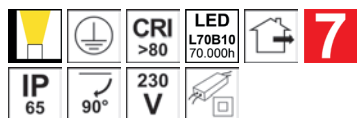

- Spot d'accentuation pour éclairage extérieur.
- Version inox 316 pour les zones côtières.
- Câble H05RN-F 3m (diamètre 7mm) et piquet à enterrer inclus.
- Convertisseur non dimmable intégré dans l'appareil.
- Boîte de connexion étanche à commander séparément.

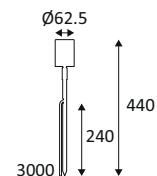

SL220 MAINS II	COULEUR	MATIÈRE	P	T°	LED LUMEN	SYSTEM LUMEN	α	€
SL220BK30MF	NEW NOIR MAT	ALUMINIUM	5,7W	3000K	620Lm	520Lm	40°	300,00
SL220SS30MF	NEW ACIER INOXYDABLE	INOX 316	5,7W	3000K	620Lm	520Lm	40°	380,00
SL220BZ30MF	NEW BRONZE	ALUMINIUM	5,7W	3000K	620Lm	520Lm	40°	320,00

ACCESSOIRES	COULEUR	MATIÈRE	DESCRIPTION	L(MM)	€
JB5			BOÎTE DE CONNEXION PARALLELE AVEC GEL IP68	93,5	49,00
GH220B	NOIR	ALUMINIUM	CYLINDRE ASYMETRIQUE		60,00
GH220D	ACIER INOXYDABLE	INOX 316	CYLINDRE ASYMETRIQUE		93,00
GH220Z	BRONZE	ALUMINIUM	CYLINDRE ASYMETRIQUE		60,00
GS220B	NOIR	ALUMINIUM	CYLINDRE BASSE LUMINANCE		60,00
GS220D	ACIER INOXYDABLE	INOX 316	CYLINDRE BASSE LUMINANCE		83,00
GS220Z	BRONZE	ALUMINIUM	CYLINDRE BASSE LUMINANCE		60,00



NOIR MAT



ACIER INOXYDABLE



BRONZE



SL230 MAINS

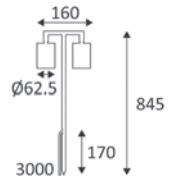
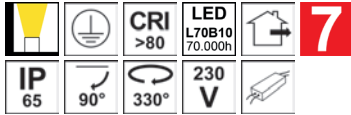

- Spot d'accentuation pour éclairage extérieur.
- Versions inox 316 pour les zones côtières.
- Câble H05RN-F 3.00m (diamètre 7mm) et piquet à enterrer inclus.
- Convertisseur non dimmable intégré dans l'appareil.
- Boîte de connexion étanche à commander séparément.

SL230 MAINS	COULEUR	MATIÈRE	P	T°	SYSTEM LUMEN	α	€
SL230BWB30	NOIR	ALUMINIUM	11,4W	3000K	1040Lm	40°	558,00
SL230DWB30	ACIER INOXYDABLE	INOX 316	11,4W	3000K	1040Lm	40°	650,00
SL230ZW30	BRONZE	ALUMINIUM	11,4W	3000K	1040Lm	40°	558,00

ACCESSOIRES	COULEUR	MATIÈRE	DESCRIPTION	L(MM)	€
JB5			BOITE DE CONNEXION PARALLELE AVEC GEL IP68	93,5	49,00
GH220B	NOIR	ALUMINIUM	CYLINDRE ASYMETRIQUE		60,00
GH220D	ACIER INOXYDABLE	INOX 316	CYLINDRE ASYMETRIQUE		93,00
GH220Z	BRONZE	ALUMINIUM	CYLINDRE ASYMETRIQUE		60,00
GS220B	NOIR	ALUMINIUM	CYLINDRE BASSE LUMINANCE		60,00
GS220D	ACIER INOXYDABLE	INOX 316	CYLINDRE BASSE LUMINANCE		83,00
GS220Z	BRONZE	ALUMINIUM	CYLINDRE BASSE LUMINANCE		60,00



NOIR



ACIER INOXYDABLE



BRONZE

SL240 MAINS

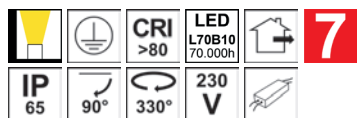

- Spot d'accentuation pour éclairage extérieur.
- Versions inox 316 pour les zones côtières.
- Câble H05RN-F 3.00m (diamètre 7mm) et piquets à enterrer inclus.
- Convertisseur non dimmable intégré dans l'appareil.
- Boîte de connexion étanche à commander séparément.

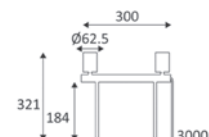

SL240 MAINS	COULEUR	MATIÈRE	P	T°	SYSTEM LUMEN	α	€
SL240BWM30	NOIR	ALUMINIUM	11,4W	3000K	1040Lm	40°	549,00
SL240DWM30	ACIER INOXYDABLE	INOX 316	11,4W	3000K	1040Lm	40°	640,00
SL240ZWM30	BRONZE	ALUMINIUM	11,4W	3000K	1040Lm	40°	549,00

ACCESSOIRES	COULEUR	MATIÈRE	DESCRIPTION	L(MM)		€
JB5			BOÎTE DE CONNEXION PARALLELE AVEC GEL IP68	93,5		49,00
GH220B	NOIR	ALUMINIUM	CYLINDRE ASYMETRIQUE			60,00
GH220D	ACIER INOXYDABLE	INOX 316	CYLINDRE ASYMETRIQUE			93,00
GH220Z	BRONZE	ALUMINIUM	CYLINDRE ASYMETRIQUE			60,00
GS220B	NOIR	ALUMINIUM	CYLINDRE BASSE LUMINANCE			60,00
GS220D	ACIER INOXYDABLE	INOX 316	CYLINDRE BASSE LUMINANCE			83,00
GS220Z	BRONZE	ALUMINIUM	CYLINDRE BASSE LUMINANCE			60,00



NOIR



ACIER INOXYDABLE



BRONZE

SL240 MAINS



INDIGO

LIGHTING



BORNES



MINO P E27

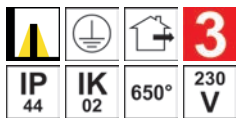

- Borne ronde pour éclairage extérieur.
- Diffuseur en verre dépoli.



MINO P E27	COULEUR	MATIÈRE	SOQUET	LAMPE	WATT MAX	€
OU43324	■ ANTHRACITE	FONTE D'ALUMINIUM	E27	CLASSIC A	26W	119,00

DANS LA MÊME GAMME



MINO W E27 PAGE 469

RONDO P E27

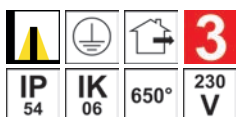

- Borne ronde pour éclairage extérieur.
- Corps anthracite et diffuseur en verre clair ou opalin.

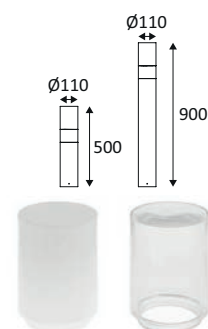

RONDO P E27	COULEUR	MATIÈRE	SOQUET	LAMPE	WATT MAX	H(MM)	€
OU40024	■ ANTHRACITE + VERRE OPALIN	FONTE D'ALUMINIUM	E27	CLASSIC A	18W	500	156,00
OU40224	■ ANTHRACITE + VERRE CLAIR	FONTE D'ALUMINIUM	E27	CLASSIC A	18W	500	156,00
OU40124	■ ANTHRACITE + VERRE OPALIN	FONTE D'ALUMINIUM	E27	CLASSIC A	18W	900	207,00
OU40324	■ ANTHRACITE + VERRE CLAIR	FONTE D'ALUMINIUM	E27	CLASSIC A	18W	900	207,00

DANS LA MÊME GAMME



ANTHRACITE +
VERRE OPALIN

ANTHRACITE +
VERRE CLAIR



RONDO W E27 PAGE 469



TULO E27

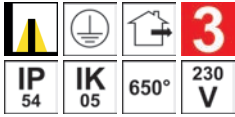

- Borne carrée pour éclairage extérieur.
- Diffuseur en verre clair.

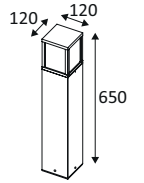

TULO E27	COULEUR	MATIÈRE	SOQUET	LAMPE	WATT MAX	€
OU41424	ANTHRACITE	ALUMINIUM	E27	CLASSIC A	15W	186,00

TULO SENSOR E27



- Borne carrée pour éclairage extérieur.
- Avec détecteur IR 100°, rayon de détection max. 6m.
- Diffuseur en verre clair.

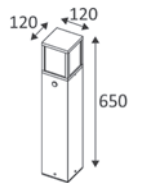

TULO SENSOR E27	COULEUR	MATIÈRE	SOQUET	LAMPE	WATT MAX	€
OU41324	ANTHRACITE	ALUMINIUM	E27	CLASSIC A	15W	210,00

ELNE 1

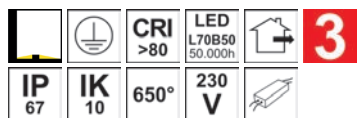

- Luminaire extérieur pour balisage.
- Une fenêtre.
- Avec entrée et sortie de câble.
- Carrossable résistance 500kg.
- Convertisseur non dimmable intégré dans l'appareil.

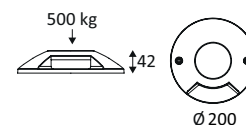

ELNE 1	COULEUR	MATIÈRE	P	T°	LED LUMEN	SYSTEM LUMEN	€
OU450WW24	■ ANTHRACITE	ALUMINIUM	6W	3000K	400Lm	290Lm	122,00

ELNE 2

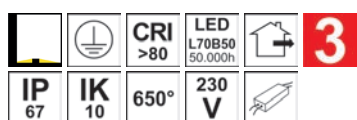

- Luminaire extérieur pour balisage.
- Deux fenêtres.
- Avec entrée et sortie de câble.
- Carrossable résistance 500kg.
- Convertisseur non dimmable intégré dans l'appareil.

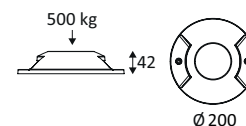

ELNE 2	COULEUR	MATIÈRE	P	T°	LED LUMEN	SYSTEM LUMEN	€
OU451WW24	■ ANTHRACITE	ALUMINIUM	12W	3000K	2x400Lm	345Lm	133,00



ELNE 4

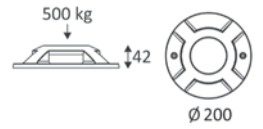
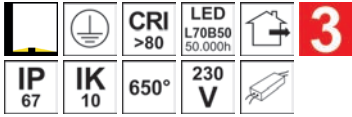

- Luminaire extérieur pour balisage.
- Quatre fenêtres.
- Avec entrée et sortie de câble.
- Carrossable résistance 500kg.
- Convertisseur non dimmable intégré dans l'appareil.

ELNE 4	COULEUR	MATIÈRE	P	T°	LED LUMEN	SYSTEM LUMEN	€
OU452WW24	■ ANTHRACITE	ALUMINIUM	12W	3000K	4x300Lm	510Lm	146,00

ELNE 1



LUXI 54

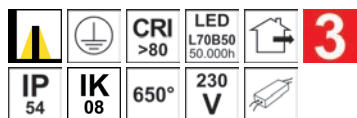

- Borne rectangulaire pour éclairage extérieur.
- Convertisseur non dimmable intégré dans l'appareil.

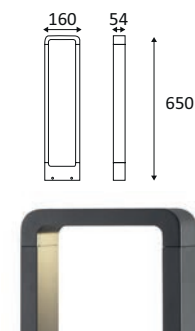

LUXI 54	COULEUR	MATIÈRE	P	T°	LED LUMEN	SYSTEM LUMEN	α	€
OU13624	■ ANTHRACITE	ALUMINIUM	7W	3000K	750Lm	525Lm	90°	217,00

RAVEL

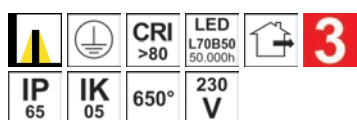

- Borne rectangulaire pour éclairage extérieur.
- Ne nécessite pas de convertisseur.

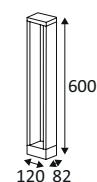

RAVEL	COULEUR	MATIÈRE	P	T°	LED LUMEN	SYSTEM LUMEN	€
OU354NW24	■ ANTHRACITE	FONTE D'ALUMINIUM	10W	4000K	1100Lm	575Lm	182,00



LUXI 180

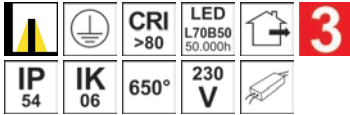

- Borne carrée pour éclairage extérieur.
- Peut être utilisé comme éclairage portatif grâce à la sortie de câble latérale.
- Convertisseur non dimmable intégré dans l'appareil.

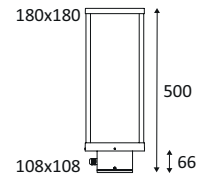

LUXI 180	COULEUR	MATIÈRE	P	T°	LED LUMEN	SYSTEM LUMEN	€
OU318NW24	■ ANTHRACITE	FONTE D'ALUMINIUM	12W	4000K	1100Lm	720Lm	258,00

LUXI 175 SENSOR P

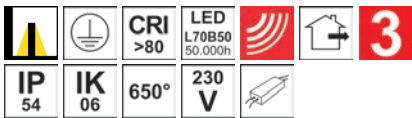

- Borne rectangulaire pour éclairage extérieur.
- Avec détecteur HF 120°, zone de détection réglable max. 8m.
- Diffuseur en polycarbonate opalin.
- Convertisseur non dimmable intégré dans l'appareil.

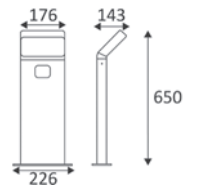

LUXI 175 SENSOR P	COULEUR	MATIÈRE	P	T°	LED LUMEN	SYSTEM LUMEN	α	€
OU367WW24	■ ANTHRACITE	ALUMINIUM	9W	3000K	1260Lm	760Lm	105°	292,00
OU367NW24	■ ANTHRACITE	ALUMINIUM	9W	4000K	1300Lm	785Lm	105°	292,00

DANS LA MÊME GAMME



LUXI 175 SENSOR PAGE 483

AMONT



- Borne rectangulaire pour éclairage extérieur.
- Convertisseur non dimmable intégré dans l'appareil.

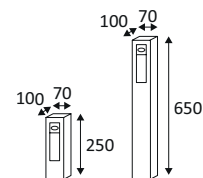

AMONT	COULEUR	MATIÈRE	P	T°	H(MM)	LED LUMEN	SYSTEM LUMEN	α	€
OU357WW24	ANTHRACITE - DORÉ	ALUMINIUM	7W	3000K	250	750Lm	90Lm	60°	133,00
OU358WW24	ANTHRACITE - DORÉ	ALUMINIUM	7W	3000K	650	750Lm	90Lm	60°	174,00

LUXI 650

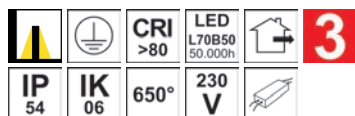

- Borne ronde pour éclairage extérieur.
- Avec entrée et sortie de câble.
- Convertisseur non dimmable intégré dans l'appareil.



LUXI 650	COULEUR	MATIÈRE	P	T°	LED LUMEN	SYSTEM LUMEN	α	€
OU13824	ANTHRACITE	FORTE D'ALUMINIUM	7W	3000K	660Lm	475Lm	30°	200,00



BREST

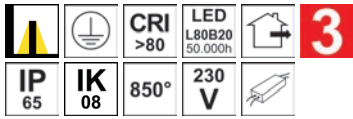

- Borne arrondie pour éclairage extérieur.
- Convertisseur non dimmable intégré dans l'appareil.

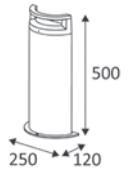

BREST	COULEUR	MATIÈRE	P	T°	LED LUMEN	SYSTEM LUMEN	α	€
OU507WW05	■ NOIR MAT	ALUMINIUM	10W	3000K	1150Lm	520Lm	50°	227,00



STELLA

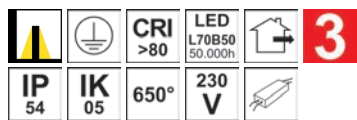

- Borne ronde pour éclairage extérieur.
- Convertisseur non dimmable intégré dans l'appareil.

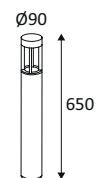

STELLA	COULEUR	MATIÈRE	P	T°	LED LUMEN	SYSTEM LUMEN	€
OU353WW24	■ ANTHRACITE	FONTE D'ALUMINIUM	8W	3000K	825Lm	500Lm	172,00
OU353NW24	■ ANTHRACITE	FONTE D'ALUMINIUM	8W	4000K	900Lm	595Lm	172,00





FINN P

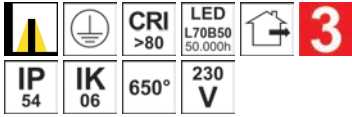

- Borne ronde pour éclairage extérieur.
- Diffuseur en polycarbonate.
- Ne nécessite pas de convertisseur.

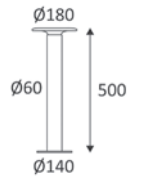

FINN P	COULEUR	MATIÈRE	P	T°	LED LUMEN	SYSTEM LUMEN	α	€
OU503WW05	■ NOIR MAT	ALUMINIUM	10W	3000K	1100Lm	935Lm	100°	143,00

DANS LA MÊME GAMME



FINN W PAGE 474



OLA 2

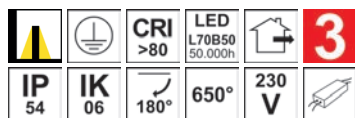

- Borne carrée pour éclairage extérieur.
- Convertisseur non dimmable intégré dans l'appareil.
- Accessoire inclus : plaque occultante amovible.

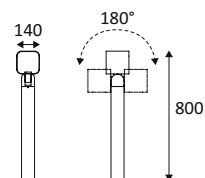

OLA 2	COULEUR	MATIÈRE	P	T°	LED LUMEN	SYSTEM LUMEN	€
OU481WW05	■ NOIR MAT	ALUMINIUM	6W	3000K	825Lm	280Lm	227,00

DANS LA MÊME GAMME



OLA 1 PAGE 420

LUXI 100 S P

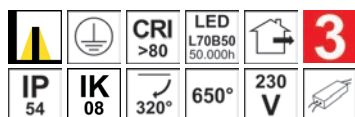

- Borne carrée pour éclairage extérieur.
- Convertisseur non dimmable intégré dans l'appareil.

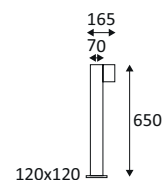

LUXI 100 S P	COULEUR	MATIÈRE	P	T°	LED LUMEN	SYSTEM LUMEN	α	€
OU356WW24	■ ANTHRACITE	ALUMINIUM	7W	3000K	660Lm	465Lm	95°	191,00

DANS LA MÊME GAMME



LUXI 100 S PAGE 479



BENS P

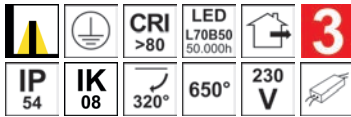

- Borne rectangulaire pour éclairage extérieur.
- Convertisseur non dimmable intégré dans l'appareil.
- Kit d'ancrage pour béton inclus.

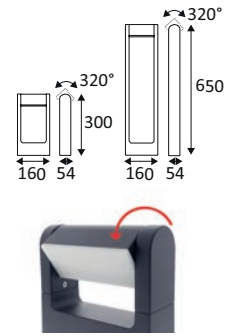

BENS P	COULEUR	MATIÈRE	P	T°	H(MM)	LED LUMEN	SYSTEM LUMEN	α	€
OU361WW24	■ ANTHRACITE	ALUMINIUM	6W	3000K	300	600Lm	435Lm	120°	160,00
OU362WW24	■ ANTHRACITE	ALUMINIUM	6W	3000K	650	600Lm	435Lm	120°	191,00

DANS LA MÊME GAMME



BENS W PAGE 480

SETO

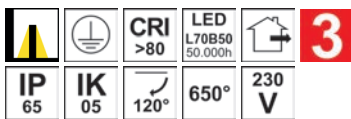

- Borne ronde pour éclairage extérieur.
- Ne nécessite pas de convertisseur.

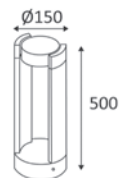



SETO	COULEUR	MATIÈRE	P	T°	LED LUMEN	SYSTEM LUMEN	α	€
OU336NW24	■ ANTHRACITE	FRONTE D'ALUMINIUM	10W	4000K	970Lm	560Lm	40°	215,00

SLIM

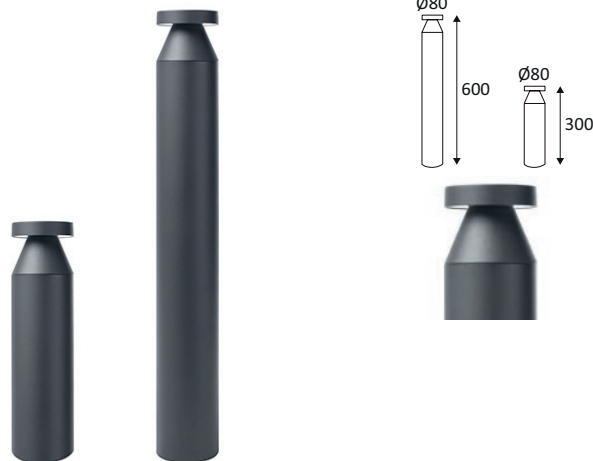

- Borne ronde pour éclairage extérieur.
- Diffuseur en verre satiné.
- 2700K, 3000K ou 4000K au choix via un interrupteur dans le luminaire.
- 2.40m de câble fourni.
- Convertisseur dimmable intégré dans l'appareil.
- Compatible avec variateur fin de phase.



SLIM	COULEUR	MATIÈRE	P	T°	H(mm)	LED LUMEN	SYSTEM LUMEN	α	€
SM030R/2A/A	NEW ANTHRACITE	FONTE D'ALUMINIUM	14W	2700K 3000K 4000K	300	1820Lm (4000K)	795Lm (4000K)	120°	197,00
SM060R/2A/A	NEW ANTHRACITE	FONTE D'ALUMINIUM	14W	2700K 3000K 4000K	600	1820Lm (4000K)	795Lm (4000K)	120°	207,00
ACCESSOIRES	DESCRIPTION								€
OU48405	CONNECTEUR 2PIN IP68								11,00
OU48505	CONNECTEUR 3PIN IP68								30,00

- Design élégant et fonctionnel.
- Éclairage uniforme à 360°.
- Multi-CCT pour choisir son atmosphère.





LUXI 80

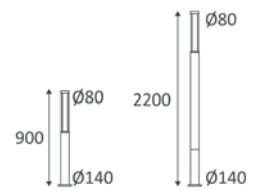
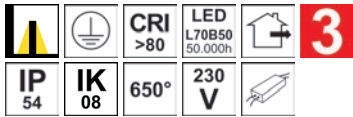

- Borne ronde pour éclairage extérieur.
- Diffuseur en polycarbonate opalin.
- Convertisseur non dimmable intégré dans l'appareil.



LUXI 80	COULEUR	MATIÈRE	P	T°	H(mm)	LED LUMEN	SYSTEM LUMEN	€
OU324WW24	■	ANTHRACITE	18W	3000K	900	2340Lm	1325Lm	284,00
OU324NW24	■	ANTHRACITE	18W	4000K	900	2410Lm	1750Lm	284,00
OU325WW24	■	ANTHRACITE	18W	3000K	2200	2340Lm	1325Lm	543,00
OU325NW24	■	ANTHRACITE	18W	4000K	2200	2410Lm	1750Lm	543,00



FILO P

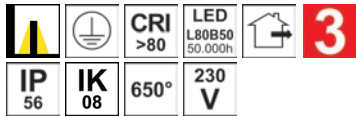

- Borne ronde pour éclairage extérieur.
- Diffuseur en polycarbonate opalin.
- Ne nécessite pas de convertisseur.

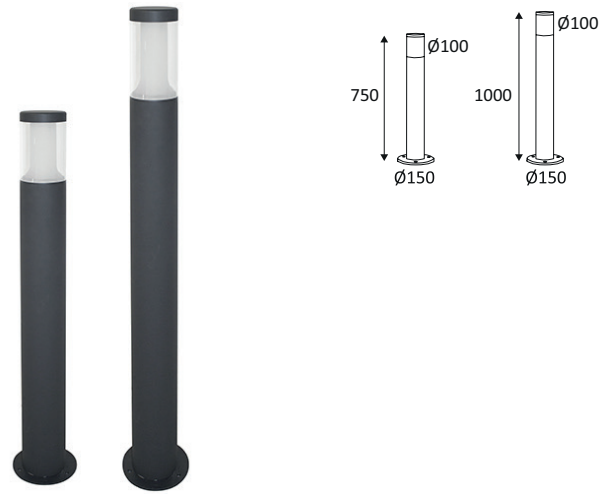

FILO P	COULEUR	MATIÈRE	P	T°	H(mm)	LED LUMEN	SYSTEM LUMEN	€
OU17724	■ ANTHRACITE	FONTE D'ALUMINIUM	8W	3000K	750	420Lm	355Lm	297,00
OU17824	■ ANTHRACITE	FONTE D'ALUMINIUM	8W	3000K	1000	420Lm	355Lm	329,00





NEW

HYDRA

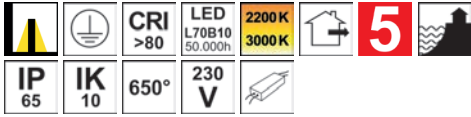

- Borne ronde pour éclairage extérieur.
- Diffuseur en polycarbonate.
- 2200K ou 3000K au choix via un interrupteur dans le luminaire.
- Multi-puissance : 14, 19 ou 24W au choix via un interrupteur dans le luminaire.
- Tête interchangeable, fût à commander séparément.
- Convertisseur non dimmable intégré dans l'appareil.
- Avec capteur de luminosité (désactivable).
- Fonctionne uniquement quand la luminosité est inférieure à 200 Lux.
- Adapté aux zones côtières.



HYDRA		COULEUR	MATIÈRE	LED	T°	SYSTEM LUMEN	α	€
HYB1OPALWPC	NEW	NOIR MAT	ALUMINIUM	14 - 19 - 24W	2200K 3000K	2200K : 1050(14W) 1450(19W) 1750(24W) 3000K : 1200(14W) 1550(19W) 1900(24W)		226,00
HYB1CONEBPC	NEW	NOIR MAT - NOIR	ALUMINIUM	14 - 19 - 24W	2200K 3000K	2200K : 1000(14W) 1400(19W) 1700(24W) 3000K : 1150(14W) 1500(19W) 1800(24W)	145°	226,00
HYB1CONESPC	NEW	NOIR MAT - ARGENT	ALUMINIUM	14 - 19 - 24W	2200K 3000K	2200K : 1300(14W) 1800(19W) 2250(24W) 3000K : 1500(14W) 1950(19W) 2400(24W)	155°	226,00
ACCESSOIRES		COULEUR	MATIÈRE	DESCRIPTION				€
HYBXBOLLARD	NEW	NOIR MAT	ALUMINIUM	FÛT + KIT DE FIXATION				162,00
HYBXSILLKIT	NEW	NOIR MAT	ALUMINIUM	REFLECTEUR 180°				53,00



NOIR MAT



NOIR MAT - NOIR



NOIR MAT - ARGENT



- Tête interchangeable facilitant la maintenance.
- Design robuste et adapté aux zones côtières.
- Limitation de la pollution lumineuse grâce à un faible ULR (<1.5% pour la version noire) et un CCT réglable à 2200K.

AVI 1

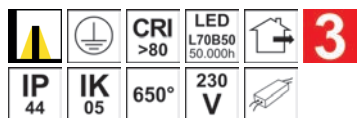

- Borne ronde pour éclairage extérieur.
- Avec prises 2P + T 16A max. 2x2000W.
- Avec alimentations distinctes pour éclairage et prises.
- Convertisseur non dimmable intégré dans l'appareil.

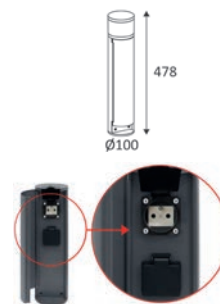

AVI 1	COULEUR	MATIÈRE	P	T°	LED LUMEN	SYSTEM LUMEN	€
OU415WW24	■ ANTHRACITE	FONTE D'ALUMINIUM	4W	3000K	475Lm	175Lm	210,00
OU415NW24	■ ANTHRACITE	FONTE D'ALUMINIUM	4W	4000K	480Lm	170Lm	210,00

AVI 2

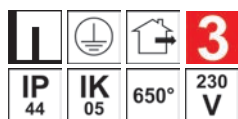

- Borne ronde pour extérieur.
- Avec prises 2P + T 16A max. 2x2000W.

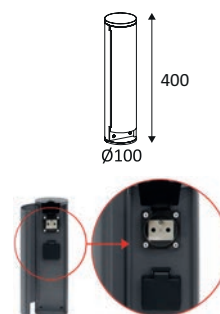

AVI 2	COULEUR	MATIÈRE	€
OU46324	■ ANTHRACITE	FONTE D'ALUMINIUM	142,00

AVI 1

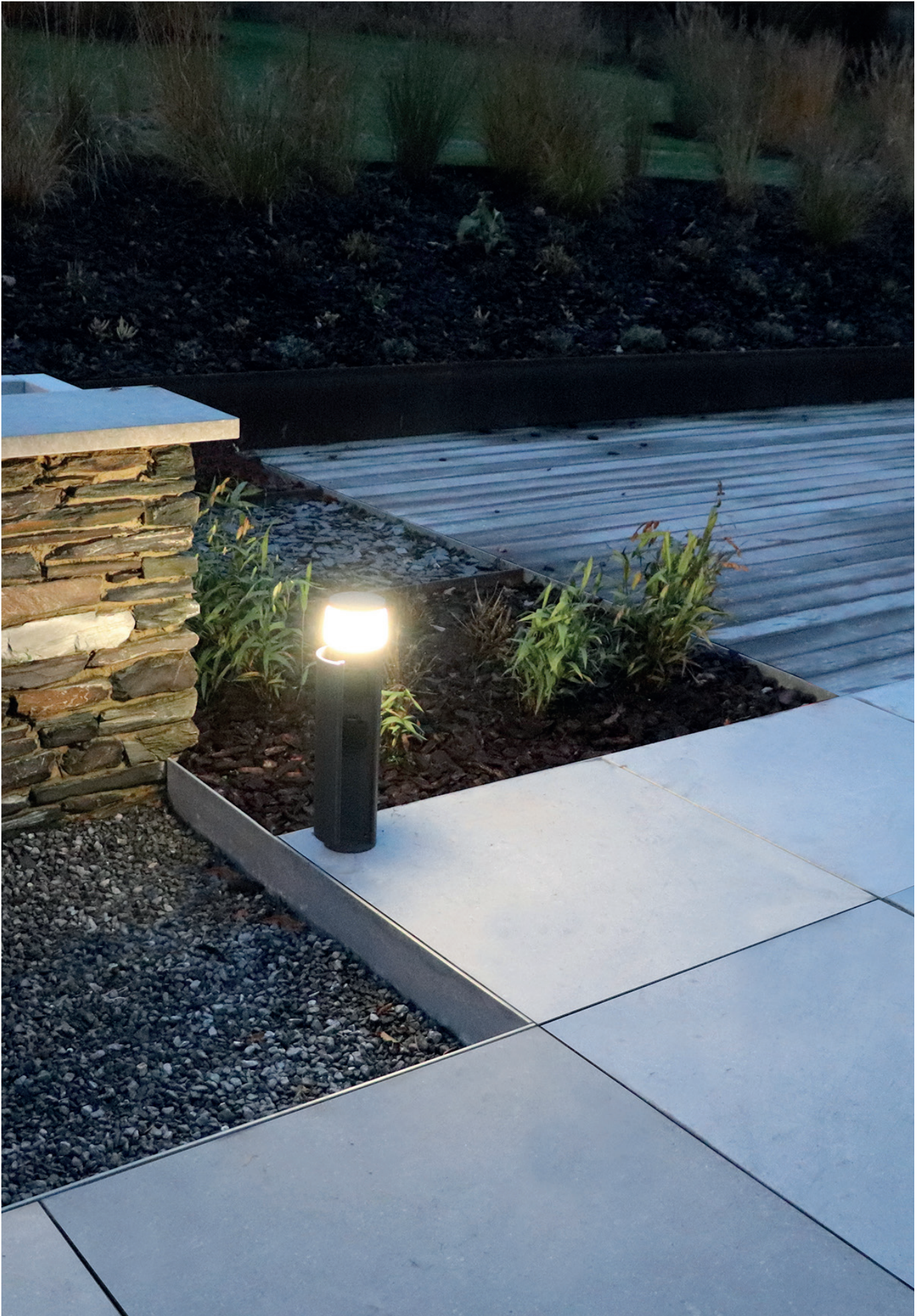

CYCLO



- Borne ronde pour éclairage extérieur.
- Diffuseur en polycarbonate.
- Convertisseur non dimmable intégré dans l'appareil.

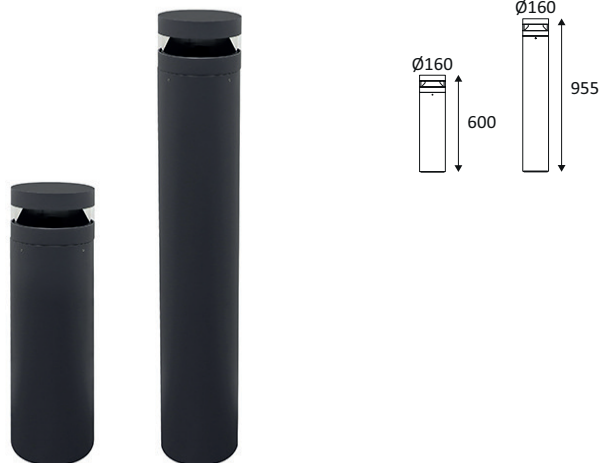

CYCLO	COULEUR	MATIÈRE	P	T°	H(mm)	LED LUMEN	SYSTEM LUMEN	€
OU515WW24	■ ANTHRACITE	FONTE D'ALUMINIUM	24W	3000K	600	2100Lm	1660Lm	446,00
OU390WW24	■ ANTHRACITE	FONTE D'ALUMINIUM	24W	3000K	955	2100Lm	1660Lm	481,00
ACCESSOIRES	COULEUR	MATIÈRE	DESCRIPTION					€
OU39224	ANTHRACITE	FONTE D'ALUMINIUM	REFLECTEUR 180°					35,00

CYCLO SENSOR



- Borne ronde pour éclairage extérieur.
- Diffuseur en polycarbonate.
- Avec détecteur IR 90°, zone de détection réglable max. 5m.
- Convertisseur non dimmable intégré dans l'appareil.



CYCLO SENSOR	COULEUR	MATIÈRE	P	T°	H(mm)	LED LUMEN	SYSTEM LUMEN	€
OU516WW24	■ ANTHRACITE	FONTE D'ALUMINIUM	24W	3000K	600	2100Lm	1660Lm	487,00
OU391WW24	■ ANTHRACITE	FONTE D'ALUMINIUM	24W	3000K	955	2100Lm	1660Lm	514,00
ACCESSOIRES	COULEUR	MATIÈRE	DESCRIPTION					€
OU39224	ANTHRACITE	FONTE D'ALUMINIUM	REFLECTEUR 180°					35,00

CYCLO



- Borne ronde pour éclairage à 360°.
- Très bonnes étanchéité (IP65) et résistance aux chocs (IK10).
- Disponible en deux hauteurs différentes.
- Kit d'ancrage pour béton inclus.
- Réflecteur pour éclairage à 180° disponible séparément.
- Garantie de 5 ans.

INDIGO

LIGHTING



ENCASTRÉS MURAUX



SLIT R

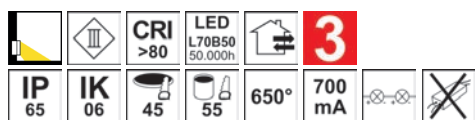

- Encastré mural extérieur rond pour balisage.
- Fixation par lamelles.
- Boîtier d'encastrement et 1.00m de câble fournis.
- Convertisseur 700mA à commander séparément.

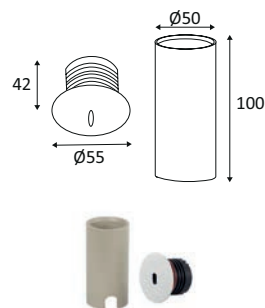

SLIT R	COULEUR	MATIÈRE	P	T°	LED LUMEN	SYSTEM LUMEN	€
OU154WW05	■ NOIR MAT	ALUMINIUM	3W	3000K	170Lm	30Lm	95,00
OU154WW30	■ BLANC MAT	ALUMINIUM	3W	3000K	170Lm	30Lm	95,00

CONVERTISSEURS ET SOURCES	WATT MAX	€
CD172	DRIVER 2-4W 700MA CC IP65	14,00
CD105	DRIVER 9-35W 700MA CC IP67	86,00



NOIR MAT



BLANC MAT

SLIT S

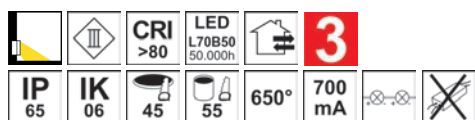

- Encastré mural extérieur carré pour balisage.
- Fixation par lamelles.
- Boîtier d'encastrement et 1.00m de câble fournis.
- Convertisseur 700mA à commander séparément.

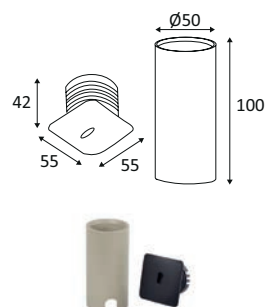

SLIT S	COULEUR	MATIÈRE	P	T°	L(MM)	LED LUMEN	SYSTEM LUMEN	€
OU158WW05	■ NOIR MAT	ALUMINIUM	3W	3000K	55	170Lm	30Lm	95,00
OU158WW30	■ BLANC MAT	ALUMINIUM	3W	3000K	55	170Lm	30Lm	95,00

CONVERTISSEURS ET SOURCES	WATT MAX	€
CD172	DRIVER 2-4W 700MA CC IP65	14,00
CD105	DRIVER 9-35W 700MA CC IP67	86,00



NOIR MAT



BLANC MAT

SLIT S



PURE 190

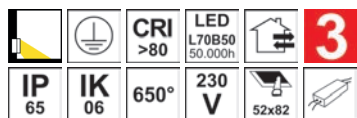

- Encastré mural extérieur rectangulaire pour balisage.
- Boîtier d'encastrement fourni.
- Convertisseur non dimmable intégré dans l'appareil.

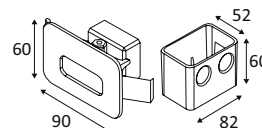

PURE 190	COULEUR	MATIÈRE	P	T°	L(MM)	LED LUMEN	SYSTEM LUMEN	€
OU190WW24	■ ANTHRACITE	ALUMINIUM	3W	3000K	90	380Lm	150Lm	154,00
OU190WW47	■ ACIER CORTEN	ALUMINIUM	3W	3000K	90	380Lm	150Lm	154,00



ANTHRACITE

ACIER CORTEN

DEVI

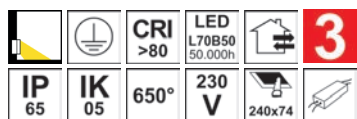

- Encastré mural extérieur rectangulaire pour balisage.
- Boîtier d'encastrement fourni.
- Avec entrée et sortie de câble.
- Convertisseur non dimmable intégré dans l'appareil.

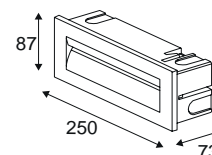

DEVI	COULEUR	MATIÈRE	P	T°	L(MM)	LED LUMEN	SYSTEM LUMEN	€
OU350NW24	■ ANTHRACITE	ALUMINIUM	8,5W	4000K	250	500Lm	190Lm	148,00



ARTSY

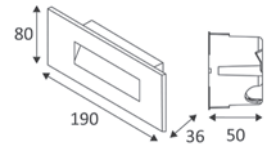
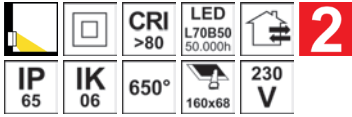

- Encastré mural extérieur rectangulaire pour balisage.
- Boîtier d'encastrement fourni.
- Ne nécessite pas de convertisseur.

ARTSY	COULEUR	MATIÈRE	P	T°	L(MM)	LED LUMEN	SYSTEM LUMEN	α	€
OU374WW37	BLANC	POLYCARBONATE + VERRE	5W	3000K	190	480Lm	200Lm	90°	130,00

DEVI



INDIGO



LIGHTING



APPLIQUES



ALTO 1 GU10

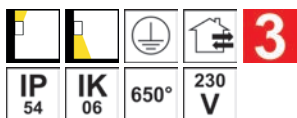

- Applique murale pour éclairage extérieur.
- Diffuseur en verre trempé clair.
- Eclairage «down».

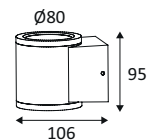

ALTO 1 GU10	COULEUR	MATIÈRE	SOQUET	LAMPE	WATT MAX	€
OU50805	■ NOIR MAT	FONTE D'ALUMINIUM	GU10	PAR16 LED	7W	68,00

ALTO 2 GU10

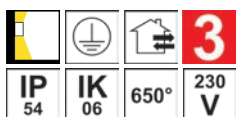

- Applique murale pour éclairage extérieur.
- Diffuseurs en verre trempé clair.
- Eclairage «up&down».

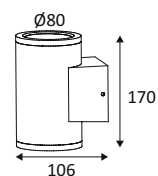

ALTO 2 GU10	COULEUR	MATIÈRE	SOQUET	LAMPE	WATT MAX	€
OU50905	■ NOIR MAT	FONTE D'ALUMINIUM	GU10	PAR16 LED	2X7W	76,00



ALTEA 1 GU10



- Applique murale pour éclairage extérieur.
- Diffuseur en verre trempé clair.
- Eclairage «down».

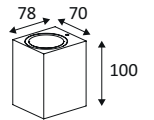

ALTEA 1 GU10	COULEUR	MATIÈRE	SOQUET	LAMPE	WATT MAX	€
OU51005	NOIR MAT	FONTE D'ALUMINIUM	GU10	PAR16 LED	7W	76,00

ALTEA 2 GU10

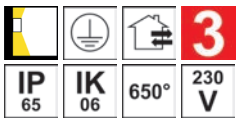

- Applique murale pour éclairage extérieur.
- Diffuseurs en verre trempé clair.
- Eclairage «up&down».
- Avec entrée et sortie de câble.

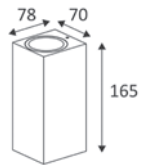

ALTEA 2 GU10	COULEUR	MATIÈRE	SOQUET	LAMPE	WATT MAX	€
OU51105	NOIR MAT	FONTE D'ALUMINIUM	GU10	PAR16 LED	2X7W	85,00

FURY S GU10

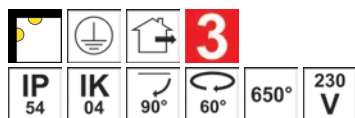

- Applique murale ou plafonnier pour éclairage extérieur.

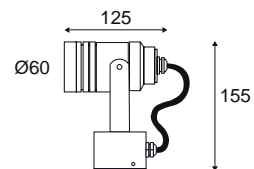

FURY S GU10	COULEUR	MATIÈRE	SOQUET	LAMPE	WATT MAX	€
OU31024	 ANTHRACITE	ALUMINIUM	GU10	PAR16 LED	7W	100,00

HUGO GU10

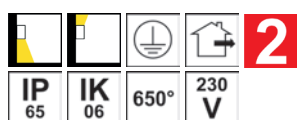

- Applique murale pour éclairage extérieur.
- Eclairage «up» ou «down».

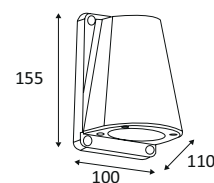

HUGO GU10	COULEUR	MATIÈRE	SOQUET	LAMPE	WATT MAX	€
BO1360A15	 ANTHRACITE	FONTE D'ALUMINIUM	GU10	PAR16 LED	7W	113,00



MINO W E27

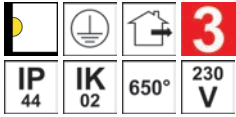

- Applique murale pour éclairage extérieur.
- Diffuseur en verre dépoli.

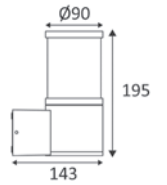

MINO W E27	COULEUR	MATIÈRE	SOQUET	LAMPE	WATT MAX	€
OU43424	ANTHRACITE	FONTE D'ALUMINIUM	E27	CLASSIC A	26W	76,00

RONDO W E27

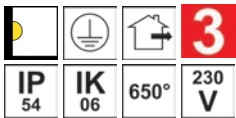

- Applique murale pour éclairage extérieur.
- Corps anthracite et diffuseur en verre clair ou opalin.

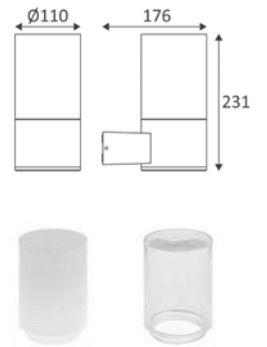

RONDO W E27	COULEUR	MATIÈRE	SOQUET	LAMPE	WATT MAX	€
OU40724	ANTHRACITE + VERRE OPALIN	FONTE D'ALUMINIUM	E27	CLASSIC A	18W	118,00
OU40824	ANTHRACITE + VERRE CLAIR	FONTE D'ALUMINIUM	E27	CLASSIC A	18W	118,00

DANS LA MÊME GAMME



ANTHRACITE

ANTHRACITE



RONDO P E27 PAGE 438

KADRO E27

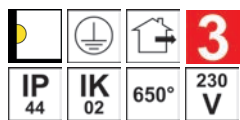

- Applique murale pour éclairage extérieur.
- Diffuseur en verre.
- Avec entrée et sortie de câble.

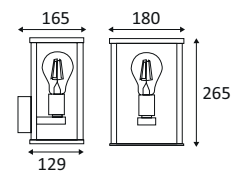

KADRO E27	COULEUR	MATIÈRE	SOQUET	LAMPE	WATT MAX	€
OU25324	■ ANTHRACITE	ALUMINIUM	E27	CLASSIC A	8W	179,00





LUXI 120 R

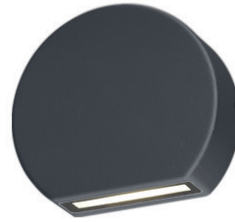
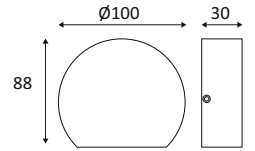
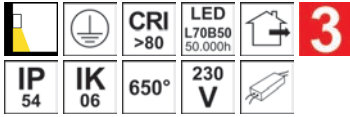

- Applique murale extérieure pour balisage.
- Convertisseur non dimmable intégré dans l'appareil.

LUXI 120 R	COULEUR	MATIÈRE	P	T°	LED LUMEN	SYSTEM LUMEN	α	€
OU14524	■ ANTHRACITE	FONTE D'ALUMINIUM	3W	3000K	180Lm	110Lm	90°	90,00

LUXI 120 S

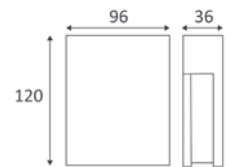
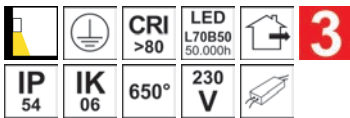

- Applique murale extérieure pour balisage.
- Diffuseur en polycarbonate.
- Convertisseur non dimmable intégré dans l'appareil.

LUXI 120 S	COULEUR	MATIÈRE	P	L(MM)	LED LUMEN	SYSTEM LUMEN	α	€
OU14624	■ ANTHRACITE	FONTE D'ALUMINIUM	3W	120	320Lm	215Lm	170°	90,00

ELBY S

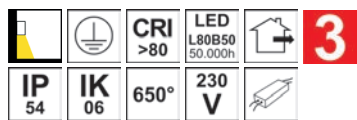

- Applique murale extérieure pour balisage.
- Convertisseur non dimmable intégré dans l'appareil.

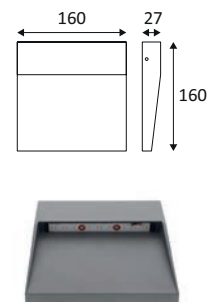

ELBY S	COULEUR	MATIÈRE	P	T°	LED LUMEN	SYSTEM LUMEN	€
OU365WW24	■ ANTHRACITE	FONTE D'ALUMINIUM	3W	3000K	390Lm	295Lm	84,00





COSTE 1

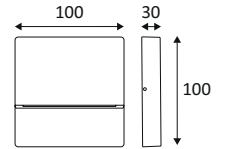
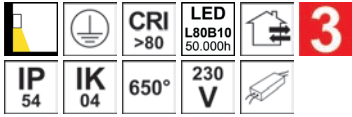

- Applique murale extérieure pour balisage.
- Convertisseur non dimmable intégré dans l'appareil.

COSTE 1	COULEUR	MATIÈRE	P	T°	LED LUMEN	SYSTEM LUMEN	α	€
OU513WW05	■ NOIR MAT	FONTE D'ALUMINIUM	4W	3000K	320Lm	175Lm	40°	60,00
OU513WW24	■ ANTHRACITE	FONTE D'ALUMINIUM	4W	3000K	320Lm	175Lm	40°	60,00



NOIR MAT



ANTHRACITE

COSTE 2

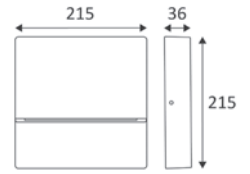
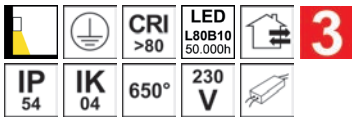

- Applique murale extérieure pour balisage.
- Avec entrée et sortie de câble.
- Convertisseur non dimmable intégré dans l'appareil.

COSTE 2	COULEUR	MATIÈRE	P	T°	LED LUMEN	SYSTEM LUMEN	α	€
OU514WW05	■ NOIR MAT	FONTE D'ALUMINIUM	8W	3000K	910Lm	295Lm	40°	103,00
OU514WW24	■ ANTHRACITE	FONTE D'ALUMINIUM	8W	3000K	910Lm	295Lm	40°	103,00



NOIR MAT



ANTHRACITE

FINN W

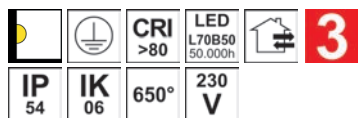

- Applique murale pour éclairage extérieur.
- Diffuseur en polycarbonate.
- Ne nécessite pas de convertisseur.

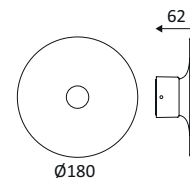

FINN W	COULEUR	MATIÈRE	P	T°	LED LUMEN	SYSTEM LUMEN	α	€
OU502WW05	■ NOIR MAT	ALUMINIUM	10W	3000K	1100Lm	965Lm	100°	84,00

DANS LA MÊME GAMME



FINN P PAGE 447

ITO



- Applique murale extérieure pour balisage.
- Ne nécessite pas de convertisseur.
- Dimmable.

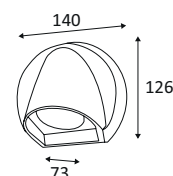

ITO	COULEUR	MATIÈRE	P	T°	LED LUMEN	SYSTEM LUMEN	€
OU340WW24	■ ANTHRACITE	FONTE D'ALUMINIUM	8W	3000K	700Lm	330Lm	147,00



WIDO

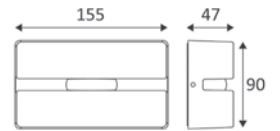
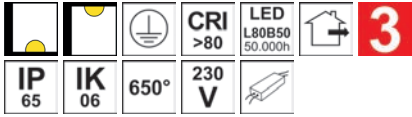

- Applique ou plafonnier décoratif extérieur.
- Effet lumineux linéaire.
- Convertisseur non dimmable intégré dans l'appareil.
- Accessoire pour montage sur surface inclinée fourni.

WIDO	COULEUR	MATIÈRE	P	T°	LED LUMEN	SYSTEM LUMEN	€
OU41024	■ ANTHRACITE	FONTE D'ALUMINIUM	3W	3000K	220Lm	75Lm	114,00



SPOTTY 1 W

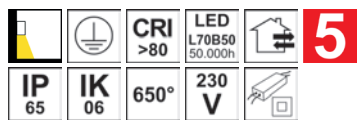

- Applique murale pour éclairage extérieur.
- Eclairage «up» ou «down».
- Convertisseur non dimmable intégré dans l'appareil.

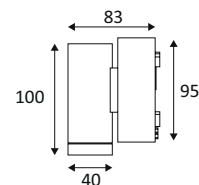

SPOTTY 1 W	COULEUR	MATIÈRE	P	T°	LED LUMEN	SYSTEM LUMEN	α	€
PT05/1A/3K/A	NEW ANTHRACITE	ALUMINIUM	6W	3000K	600Lm	400Lm	30°	170,00

DANS LA MÊME GAMME

SPOTTY 1 P PAGE 426

SPOTTY 2 P PAGE 427





NEW

SPOTTY 2 W

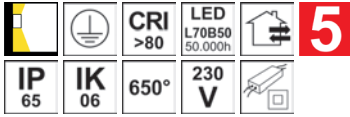

- Applique murale pour éclairage extérieur.
- Eclairage «up & down».
- Convertisseur non dimmable intégré dans l'appareil.

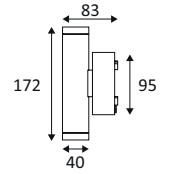

SPOTTY 2 W	COULEUR	MATIÈRE	P	T°	LED LUMEN	SYSTEM LUMEN	α	€
PT05/2A/3K/A	NEW ANTHRACITE	ALUMINIUM	11,5W	3000K	2X600Lm	800Lm	30°	210,00

DANS LA MÊME GAMME

SPOTTY 1 P PAGE 426

SPOTTY 2 P PAGE 427

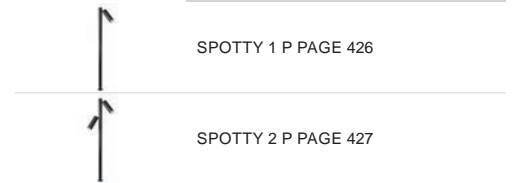

SPOTTY 3 W

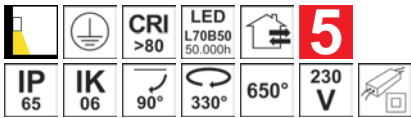

- Applique murale orientable pour éclairage extérieur.
- Convertisseur non dimmable intégré dans l'appareil.

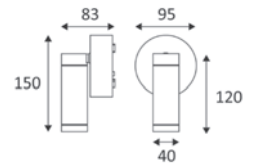

SPOTTY 3 W	COULEUR	MATIÈRE	P	T°	LED LUMEN	SYSTEM LUMEN	α	€
PT05/M/3K/A	NEW ANTHRACITE	ALUMINIUM	6W	3000K	600Lm	400Lm	30°	195,00

DANS LA MÊME GAMME

SPOTTY 1 P PAGE 426

SPOTTY 2 P PAGE 427

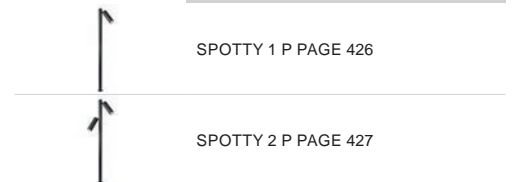

NEW

GUNZY S

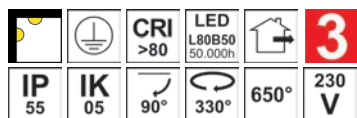

- Applique murale ou plafonnier pour éclairage extérieur.
- Base apparente avec entrée et sortie de câble.
- Ne nécessite pas de convertisseur.
- Non dimmable.

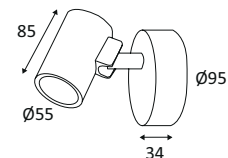

GUNZY S	COULEUR	MATIÈRE	P	T°	LED LUMEN	SYSTEM LUMEN	α	€
OU18524	■ ANTHRACITE	FONTE D'ALUMINIUM	8W	3000K	760Lm	465Lm	38°	182,00

DANS LA MÊME GAMME



GUNZY PAGE 428



GUNZY P PAGE 429



GUNZY 2 S PAGE 478



GUNZY 2 P PAGE 430

GUNZY 2 S

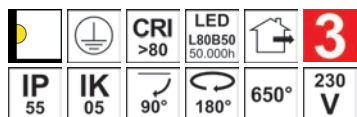

- Applique murale pour éclairage extérieur.
- Base apparente avec entrée et sortie de câble.
- Ne nécessite pas de convertisseur.
- Non dimmable.

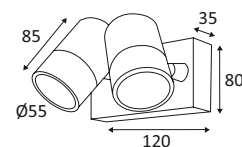

GUNZY 2 S	COULEUR	MATIÈRE	P	T°	LED LUMEN	SYSTEM LUMEN	α	€
OU18624	■ ANTHRACITE	FONTE D'ALUMINIUM	16W	3000K	2X760Lm	925Lm	38°	339,00

DANS LA MÊME GAMME



GUNZY PAGE 428



GUNZY P PAGE 429



GUNZY 2 P PAGE 430



GUNZY S PAGE 478



LUXI 100 S

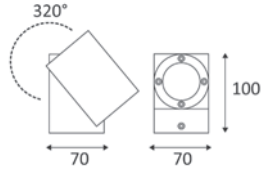

- Applique murale pour éclairage extérieur.
- Convertisseur non dimmable intégré dans l'appareil.

LUXI 100 S	COULEUR	MATIÈRE	P	T°	LED LUMEN	SYSTEM LUMEN	α	€
OU14324	■ ANTHRACITE	FONTE D'ALUMINIUM	7W	3000K	660Lm	465Lm	95°	155,00

DANS LA MÊME GAMME



LUXI 100 S P PAGE 448



BENS W

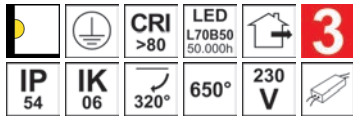

- Applique murale pour éclairage extérieur.
- Convertisseur non dimmable intégré dans l'appareil.

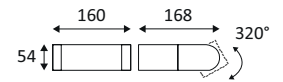

BENS W	COULEUR	MATIÈRE	P	T°	LED LUMEN	SYSTEM LUMEN	α	€
OU360WW24	■ ANTHRACITE	FONTE D'ALUMINIUM	6W	3000K	600Lm	435Lm	120°	152,00

DANS LA MÊME GAMME



BENS P PAGE 449





ARCOLE

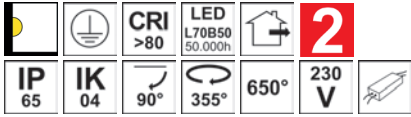

- Applique murale pour éclairage extérieur.
- Base apparente avec entrée et sortie de câble.
- Faisceau ajustable de 18° à 60°.
- Convertisseur non dimmable intégré dans l'appareil.

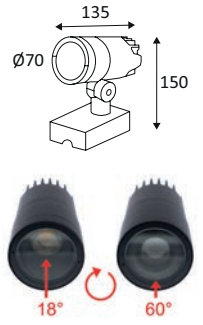

ARCOLE	COULEUR	MATIÈRE	P	T°	LED LUMEN	SYSTEM LUMEN	α	€
OU375WW24	■ ANTHRACITE	FORTE D'ALUMINIUM	8W	3000K	800Lm	455Lm	18-60°	213,00

DANI

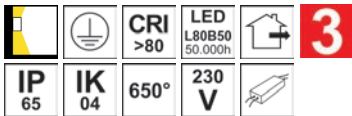

- Applique murale pour éclairage extérieur.
- Base apparente avec entrée et sortie de câble.
- Eclairage «up&down».
- Convertisseur non dimmable intégré dans l'appareil.

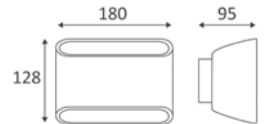

DANI	COULEUR	MATIÈRE	P	T°	LED LUMEN	SYSTEM LUMEN	€
OU15024	■ ANTHRACITE	FORTE D'ALUMINIUM	10W	3000K	500Lm	590Lm	290,00

LUXI 45

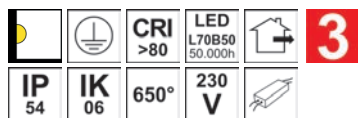

- Applique murale pour éclairage extérieur.
- Diffuseur en polycarbonate opalin.
- Convertisseur non dimmable intégré dans l'appareil.

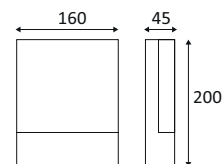

LUXI 45	COULEUR	MATIÈRE	P	T°	LED LUMEN	SYSTEM LUMEN	α	€
OU20624	■ ANTHRACITE	ALUMINIUM	6W	3000K	660Lm	555Lm	120°	143,00

LUXI 45 SENSOR



- Applique murale pour éclairage extérieur.
- Avec détecteur IR 120°, zone de détection réglable max. 6m.
- Diffuseur en polycarbonate opalin.
- Convertisseur non dimmable intégré dans l'appareil.

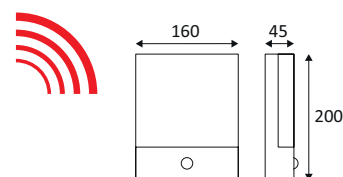

LUXI 45 SENSOR	COULEUR	MATIÈRE	P	T°	LED LUMEN	SYSTEM LUMEN	α	€
OU359WW24	■ ANTHRACITE	ALUMINIUM	6W	3000K	660Lm	555Lm	120°	170,00



LUXI 175 SENSOR

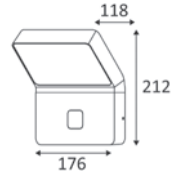
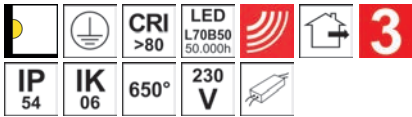

- Applique murale pour éclairage extérieur.
- Avec détecteur HF 120°, zone de détection réglable max. 8m.
- Diffuseur en polycarbonate opalin.
- Convertisseur non dimmable intégré dans l'appareil.

LUXI 175 SENSOR	COULEUR	MATIÈRE	P	T°	LED LUMEN	SYSTEM LUMEN	α	€
OU323WW24	■ ANTHRACITE	ALUMINIUM	9W	3000K	1260Lm	760Lm	105°	220,00
OU323WW30	■ BLANC	ALUMINIUM	9W	3000K	1260Lm	950Lm	105°	220,00
OU323NW24	■ ANTHRACITE	ALUMINIUM	9W	4000K	1300Lm	785Lm	105°	220,00
OU323NW30	■ BLANC	ALUMINIUM	9W	4000K	1300Lm	980Lm	105°	220,00



ANTHRACITE



BLANC

DANS LA MÊME GAMME



LUXI 175 SENSOR P PAGE 443

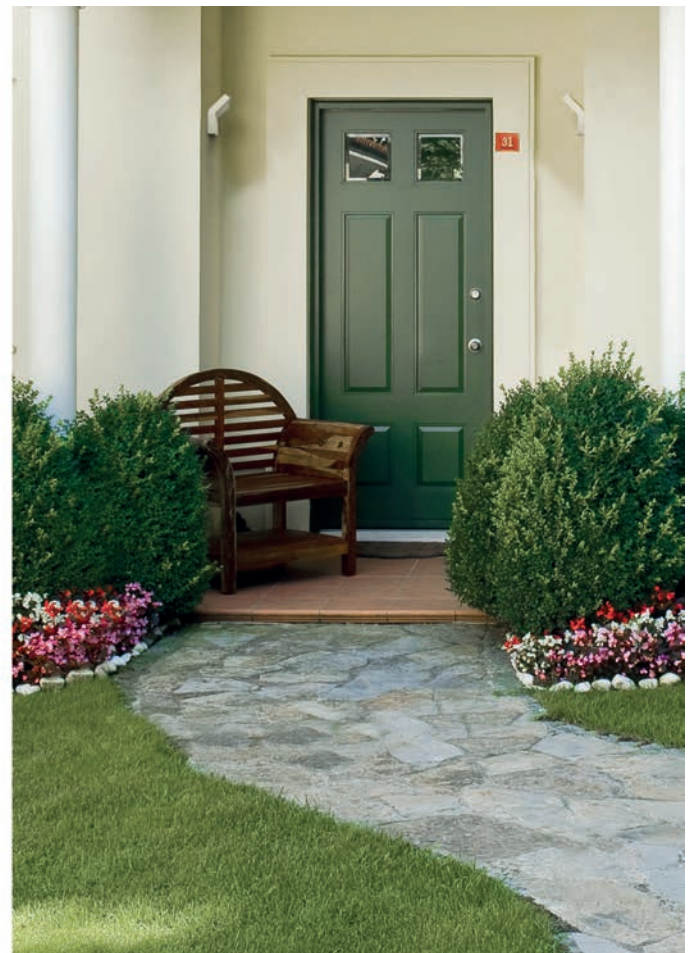

LUXI 139

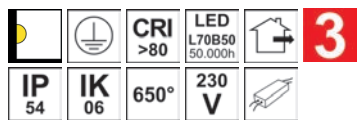

- Applique murale pour éclairage extérieur.
- Diffuseur en polycarbonate opalin.
- Convertisseur non dimmable intégré dans l'appareil.

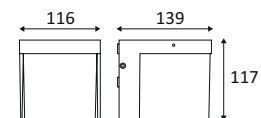

LUXI 139	COULEUR	MATIÈRE	P	T°	LED LUMEN	SYSTEM LUMEN	α	€
OU13524	■ ANTHRACITE	FORTE D'ALUMINIUM	3,8W	3000K	400Lm	315Lm	110°	95,00





EDGY

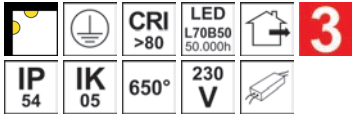

- Applique murale ou plafonnier pour éclairage extérieur.
- Diffuseur en polycarbonate opalin.
- Avec entrée et sortie de câble.
- Convertisseur non dimmable intégré dans l'appareil.

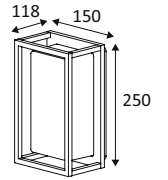

EDGY	COULEUR	MATIÈRE	P	T°	LED LUMEN	SYSTEM LUMEN	α	€
OU467WW24	■ ANTHRACITE	FONTE D'ALUMINIUM	15W	3000K	1730Lm	950Lm	120°	154,00

LANTERN

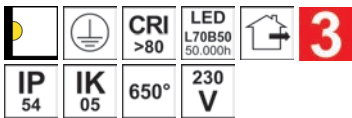

- Applique murale pour éclairage extérieur.
- Diffuseur en polycarbonate opalin.
- Ne nécessite pas de convertisseur.
- Non dimmable.



LANTERN	COULEUR	MATIÈRE	P	T°	LED LUMEN	SYSTEM LUMEN	α	€
OU344WW24	■ ANTHRACITE	FONTE D'ALUMINIUM	18W	3000K	1500Lm	845Lm	110°	130,00



LUXI 190

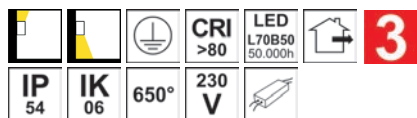

- Applique murale pour éclairage extérieur.
- Eclairage «up» ou «down».
- Convertisseur non dimmable intégré dans l'appareil.

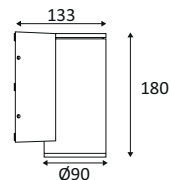

LUXI 190	COULEUR	MATIÈRE	P	T°	LED LUMEN	SYSTEM LUMEN	α	€
OU10524	■ ANTHRACITE	FORTE D'ALUMINIUM	12W	3000K	850Lm	585Lm	65°	182,00

LUXI 290

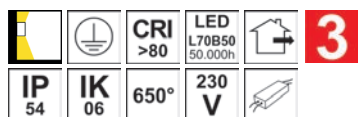

- Applique murale pour éclairage extérieur.
- Eclairage «up&down».
- Convertisseur non dimmable intégré dans l'appareil.

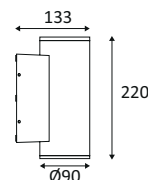

LUXI 290	COULEUR	MATIÈRE	P	T°	LED LUMEN	SYSTEM LUMEN	α	€
OU10624	■ ANTHRACITE	FORTE D'ALUMINIUM	24W	3000K	2X850Lm	1170Lm	65°	271,00



LUXI 95

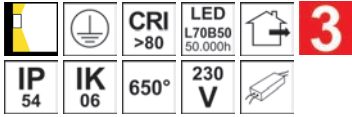

- Applique murale pour éclairage extérieur.
- Eclairage «up&down».
- Convertisseur non dimmable intégré dans l'appareil.

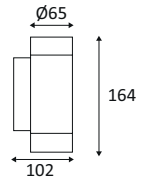

LUXI 95	COULEUR	MATIÈRE	P	T°	LED LUMEN	SYSTEM LUMEN	α	€
OU14424	■ ANTHRACITE	FORTE D'ALUMINIUM	6W	3000K	2X220Lm	380Lm	90°	155,00

CHERA

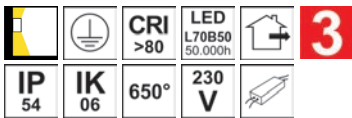

- Applique murale pour éclairage extérieur.
- Eclairage «up&down».
- Convertisseur non dimmable intégré dans l'appareil.

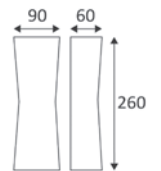

CHERA	COULEUR	MATIÈRE	P	T°	LED LUMEN	SYSTEM LUMEN	α	€
OU363WW24	■ ANTHRACITE	FORTE D'ALUMINIUM	12W	3000K	2X680Lm	890Lm	90°	140,00

ALMA R



- Applique murale pour éclairage extérieur.
- Eclairage «up&down».
- Convertisseur non dimmable intégré dans l'appareil.

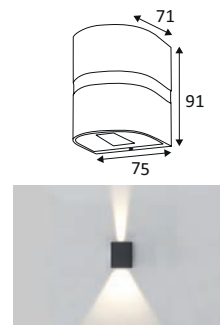

ALMA R	COULEUR	MATIÈRE	P	T°	LED LUMEN	SYSTEM LUMEN	α	€
OU431WW24	■ ANTHRACITE	FONTE D'ALUMINIUM	6W	3000K	200Lm	135Lm	40°	76,00

ALMA S

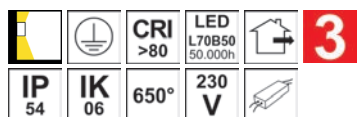

- Applique murale pour éclairage extérieur.
- Eclairage «up&down».
- Convertisseur non dimmable intégré dans l'appareil.

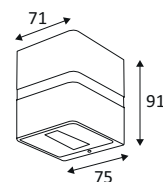

ALMA S	COULEUR	MATIÈRE	P	T°	LED LUMEN	SYSTEM LUMEN	α	€
OU387WW24	■ ANTHRACITE	FONTE D'ALUMINIUM	6W	3000K	200Lm	135Lm	40°	79,00

ALMA R



KOPA

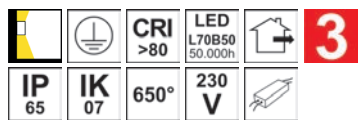

- Applique murale pour éclairage extérieur.
- Eclairage «up&down».
- Convertisseur non dimmable intégré dans l'appareil.

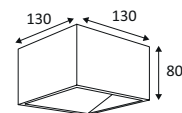

KOPA	COULEUR	MATIÈRE	P	T°	LED LUMEN	SYSTEM LUMEN	€
OU438WW24	■ ANTHRACITE	FORTE D'ALUMINIUM	9W	3000K	695Lm	620Lm	255,00
ACCESSOIRES	COULEUR	MATIÈRE	DESCRIPTION				€
OU43924	■ ANTHRACITE	ALUMINIUM	COUVERCLE LAME DE LUMIERE				37,00





KUBO

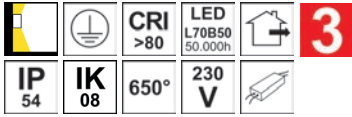

- Applique murale pour éclairage extérieur.
- Eclairage «up&down».
- Convertisseur non dimmable intégré dans l'appareil.

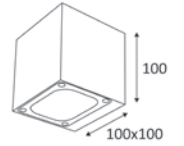

KUBO	COULEUR	MATIÈRE	P	T°	LED LUMEN	SYSTEM LUMEN	α	€
OU334WW24	■ ANTHRACITE	FORTE D'ALUMINIUM	12W	3000K	2X500Lm	775Lm	30°	133,00



KOS 1 S

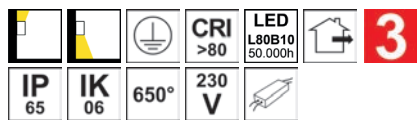

- Applique murale pour éclairage extérieur.
- Diffuseur en verre.
- Eclairage «up» ou «down».
- Avec entrée et sortie de câble.
- Convertisseur non dimmable intégré dans l'appareil.

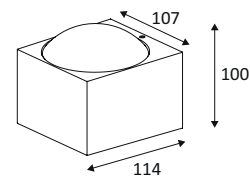

KOS 1 S	COULEUR	MATIÈRE	P	T°	LED LUMEN	SYSTEM LUMEN	α	€
OU477WW24	■ ANTHRACITE	FONTE D'ALUMINIUM	6W	3000K	750Lm	675Lm	80°	187,00

KOS 2 R

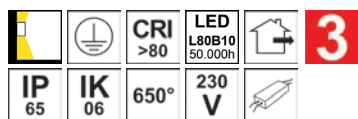

- Applique murale pour éclairage extérieur.
- Diffuseurs en verre.
- Eclairage «up&down».
- Avec entrée et sortie de câble.
- Convertisseur non dimmable intégré dans l'appareil.

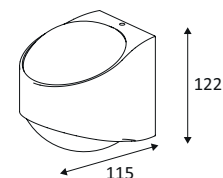

KOS 2 R	COULEUR	MATIÈRE	P	T°	LED LUMEN	SYSTEM LUMEN	α	€
OU479WW24	■ ANTHRACITE	FONTE D'ALUMINIUM	12W	3000K	2X685Lm	1150Lm	80°	227,00



KOS 2 S

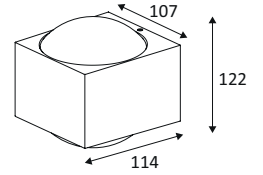
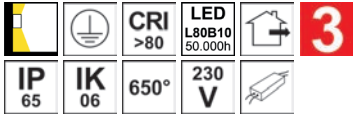

- Applique murale pour éclairage extérieur.
- Diffuseurs en verre.
- Eclairage «up&down».
- Avec entrée et sortie de câble.
- Convertisseur non dimmable intégré dans l'appareil.

KOS 2 S	COULEUR	MATIÈRE	P	T°	LED LUMEN	SYSTEM LUMEN	α	€
OU478WW24	■ ANTHRACITE	FORTE D'ALUMINIUM	12W	3000K	2X685Lm	1150Lm	80°	237,00

KOS 2 R



NORA

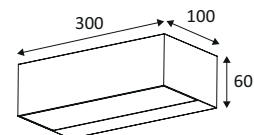
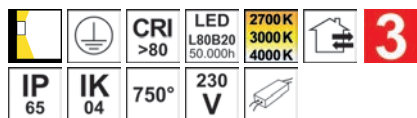

- Applique murale pour éclairage extérieur.
- 2700K, 3000K ou 4000K au choix via un interrupteur dans le luminaire.
- Diffuseurs en verre trempé dépoli.
- Eclairage «up&down».
- Avec entrée et sortie de câble.
- Convertisseur non dimmable intégré dans l'appareil.



NORA	COULEUR	MATIÈRE	P	T°	LED LUMEN	SYSTEM LUMEN	€
OU49205	■ NOIR MAT	ALUMINIUM	15W	2700K 3000K 4000K	2100Lm (4000K)	1070Lm (4000K)	154,00





HARRY A

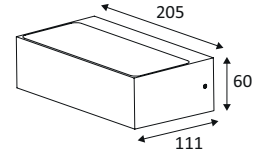
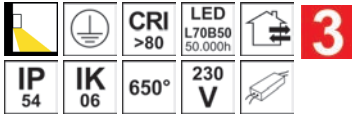

- Applique murale pour éclairage extérieur.
- Eclairage «down».
- Faisceau asymétrique.
- Avec entrée et sortie de câble.
- Convertisseur non dimmable intégré dans l'appareil.

HARRY A	COULEUR	MATIÈRE	P	T°	LED LUMEN	SYSTEM LUMEN	α	€
OU501WW05	■ NOIR MAT	ALUMINIUM	16W	3000K	1370Lm	1005Lm	60°	206,00
OU501NW05	■ NOIR MAT	ALUMINIUM	16W	4000K	1370Lm	1125Lm	60°	206,00

ONEO A

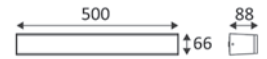
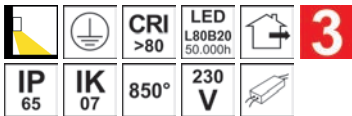

- Applique murale pour éclairage extérieur.
- Eclairage «down».
- Faisceau asymétrique.
- Avec entrée et sortie de câble.
- Convertisseur non dimmable intégré dans l'appareil.

ONEO A	COULEUR	MATIÈRE	P	T°	LED LUMEN	SYSTEM LUMEN	€
OU453WW24	■ ANTHRACITE	FORTE D'ALUMINIUM	15W	3000K	1350Lm	965Lm	236,00

BRIKPRO 1

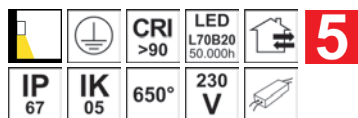

- Applique murale pour éclairage extérieur.
- Diffuseur en verre opalin.
- Eclairage direct.
- Convertisseur non dimmable intégré dans l'appareil.

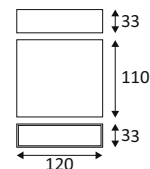

BRIKPRO 1	COULEUR	MATIÈRE	P	T°	LED LUMEN	SYSTEM LUMEN	α	€
BP121D/3K/A	ANTHRACITE	FONTE D'ALUMINIUM	7W	3000K	870Lm	695Lm	80°	100,00
BP121D/3K/G	GRIS MAT	FONTE D'ALUMINIUM	7W	3000K	870Lm	695Lm	80°	100,00
BP121D/3K/W	BLANC MAT	FONTE D'ALUMINIUM	7W	3000K	870Lm	695Lm	80°	100,00
BP121D/3K/BR	ACIER CORTEN	FONTE D'ALUMINIUM	7W	3000K	870Lm	695Lm	80°	104,00



ANTHRACITE



GRIS MAT



BLANC MAT



ACIER CORTEN

BRIKPRO 1 A

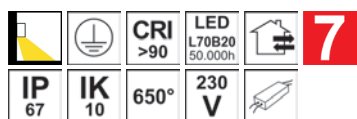

- Applique murale pour éclairage extérieur.
- Diffuseur en verre sérigraphié noir.
- Faisceau asymétrique.
- Eclairage direct.
- Convertisseur non dimmable intégré dans l'appareil.

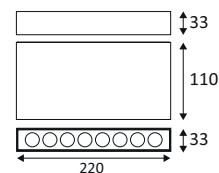
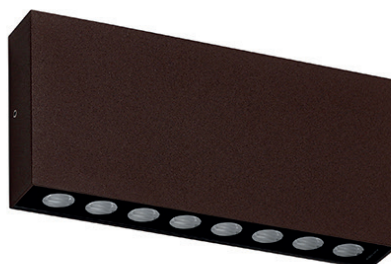

BRIKPRO 1 A	COULEUR	MATIÈRE	P	T°	LED LUMEN	SYSTEM LUMEN	α	€
BP221C/3K/A	ANTHRACITE	FONTE D'ALUMINIUM	14W	3000K	1300Lm	940Lm	40°	221,00
BP221C/3K/G	GRIS MAT	FONTE D'ALUMINIUM	14W	3000K	1300Lm	940Lm	40°	221,00
BP221C/3K/W	BLANC MAT	FONTE D'ALUMINIUM	14W	3000K	1300Lm	940Lm	40°	221,00
BP221C/3K/BR	ACIER CORTEN	FONTE D'ALUMINIUM	14W	3000K	1300Lm	940Lm	40°	227,00



ANTHRACITE



GRIS MAT



BLANC MAT



ACIER CORTEN



BRIKPRO 1



BRIKPRO 2



- Applique murale pour éclairage extérieur.
- Diffuseurs en verre opalin.
- Eclairage direct/indirect.
- Convertisseur non dimmable intégré dans l'appareil.

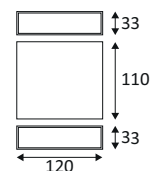
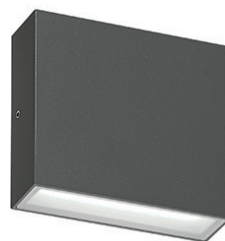

BRIKPRO 2	COULEUR	MATIÈRE	P	T°	LED LUMEN	SYSTEM LUMEN	α	€
BP12/2D/3K/A	ANTHRACITE	FONTE D'ALUMINIUM	14W	3000K	2X870Lm	1390Lm	80°	118,00
BP12/2D/3K/G	GRIS MAT	FONTE D'ALUMINIUM	14W	3000K	2X870Lm	1390Lm	80°	118,00
BP12/2D/3K/W	BLANC MAT	FONTE D'ALUMINIUM	14W	3000K	2X870Lm	1390Lm	80°	118,00
BP12/2D/3K/BR	ACIER CORTEN	FONTE D'ALUMINIUM	14W	3000K	2X870Lm	1390Lm	80°	123,00



ANTHRACITE



GRIS MAT



BLANC MAT



ACIER CORTEN

BRIKPRO 2 A

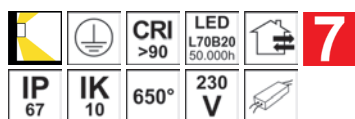

- Applique murale pour éclairage extérieur.
- Diffuseurs en verre sérigraphié noir.
- Faisceaux asymétriques.
- Eclairage direct/indirect.
- Convertisseur non dimmable intégré dans l'appareil.

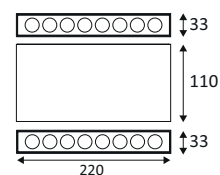
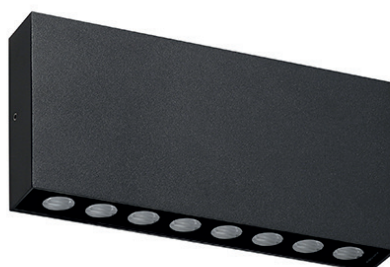

BRIKPRO 2 A	COULEUR	MATIÈRE	P	T°	LED LUMEN	SYSTEM LUMEN	α	€
BP22/2C/3K/A	ANTHRACITE	FONTE D'ALUMINIUM	28W	3000K	2X1300Lm	1880Lm	40°	248,00
BP22/2C/3K/G	GRIS MAT	FONTE D'ALUMINIUM	28W	3000K	2X1300Lm	1880Lm	40°	248,00
BP22/2C/3K/W	BLANC MAT	FONTE D'ALUMINIUM	28W	3000K	2X1300Lm	1880Lm	40°	248,00
BP22/2C/3K/BR	ACIER CORTEN	FONTE D'ALUMINIUM	28W	3000K	2X1300Lm	1880Lm	40°	255,00



ANTHRACITE



GRIS MAT



BLANC MAT



ACIER CORTEN



POLO

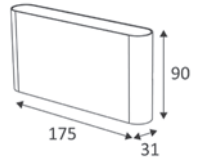
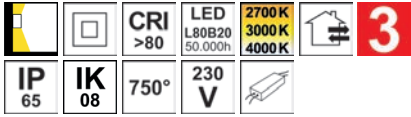

- Applique murale pour éclairage extérieur.
- 2700K, 3000K ou 4000K au choix via un interrupteur dans le luminaire.
- Eclairage «up&down».
- Avec entrée et sortie de câble.
- Convertisseur non dimmable intégré dans l'appareil.

POLO	COULEUR	MATIÈRE	P	T°	LED LUMEN	SYSTEM LUMEN	€
OU49505	NOIR MAT	ALUMINIUM	10W	2700K 3000K 4000K	600Lm (4000K)	1040Lm (4000K)	99,00
OU49530	BLANC MAT	ALUMINIUM	10W	2700K 3000K 4000K	600Lm (4000K)	1110Lm (4000K)	99,00



NOIR MAT



BLANC MAT



INDIGO

LIGHTING



PLAFONNIERS



ROMY R GU10

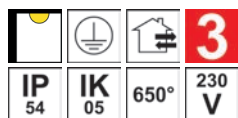

- Plafonnier rond pour éclairage extérieur.
- Diffuseur en verre.
- Avec entrée et sortie de câble.

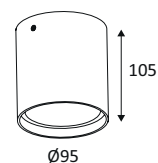

ROMY R GU10	COULEUR	MATIÈRE	SOQUET	LAMPE	WATT MAX	€
OU50405	■ NOIR MAT	ALUMINIUM	GU10	PAR16 LED	7W	70,00
OU50430	■ BLANC MAT	ALUMINIUM	GU10	PAR16 LED	7W	70,00



NOIR MAT



BLANC MAT

ROMY S GU10

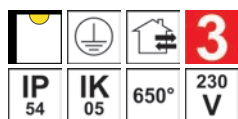

- Plafonnier carré pour éclairage extérieur.
- Diffuseur en verre.
- Avec entrée et sortie de câble.

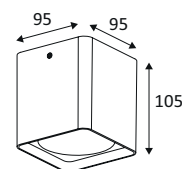

ROMY S GU10	COULEUR	MATIÈRE	L(MM)	SOQUET	LAMPE	WATT MAX	€
OU50505	■ NOIR MAT	ALUMINIUM	95	GU10	PAR16 LED	7W	70,00
OU50530	■ BLANC MAT	ALUMINIUM	95	GU10	PAR16 LED	7W	70,00



NOIR MAT



BLANC MAT



ROMY R GU10



LEWIS

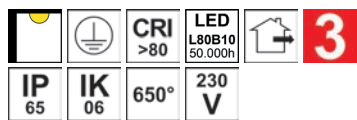

- Plafonnier pour éclairage extérieur.
- Diffuseur en verre.
- Ne nécessite pas de convertisseur.
- Non dimmable.

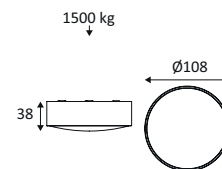

LEWIS	COULEUR	MATIÈRE	P	T°	LED LUMEN	SYSTEM LUMEN	α	€
OU424WW24	■ ANTHRACITE	FONTE D'ALUMINIUM	6W	3000K	470Lm	320Lm	95°	114,00





ILY

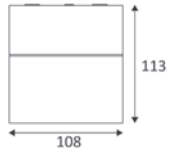
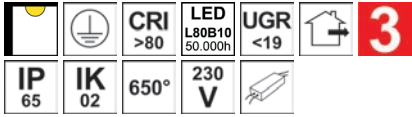

- Plafonnier pour éclairage extérieur.
- Diffuseur en verre.
- Convertisseur non dimmable intégré dans l'appareil.

ILY	COULEUR	MATIÈRE	P	T°	LED LUMEN	SYSTEM LUMEN	α	€
OU512WW05	■ NOIR MAT	FORTE D'ALUMINIUM	5W	3000K	450Lm	210Lm	40°	131,00
OU512WW24	■ ANTHRACITE	FORTE D'ALUMINIUM	5W	3000K	450Lm	210Lm	40°	131,00



NOIR MAT



ANTHRACITE



UNIS R

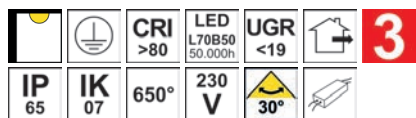

- Plafonnier rond pour éclairage extérieur.
- Réflecteur basse luminance.
- Avec entrée et sortie de câble.
- Convertisseur non dimmable intégré dans l'appareil.

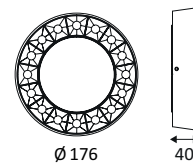

UNIS R	COULEUR	MATIÈRE	P	T°	LED LUMEN	SYSTEM LUMEN	α	€
OU459WW24	■ ANTHRACITE	ALUMINIUM	14W	3000K	1250Lm	1090Lm	30°	175,00

UNIS S



- Plafonnier carré pour éclairage extérieur.
- Réflecteur basse luminance.
- Avec entrée et sortie de câble.
- Convertisseur non dimmable intégré dans l'appareil.

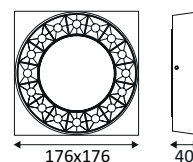

UNIS S	COULEUR	MATIÈRE	P	T°	LED LUMEN	SYSTEM LUMEN	α	€
OU460WW24	■ ANTHRACITE	ALUMINIUM	14W	3000K	1250Lm	1090Lm	30°	175,00



UNIS S



LUZ 1

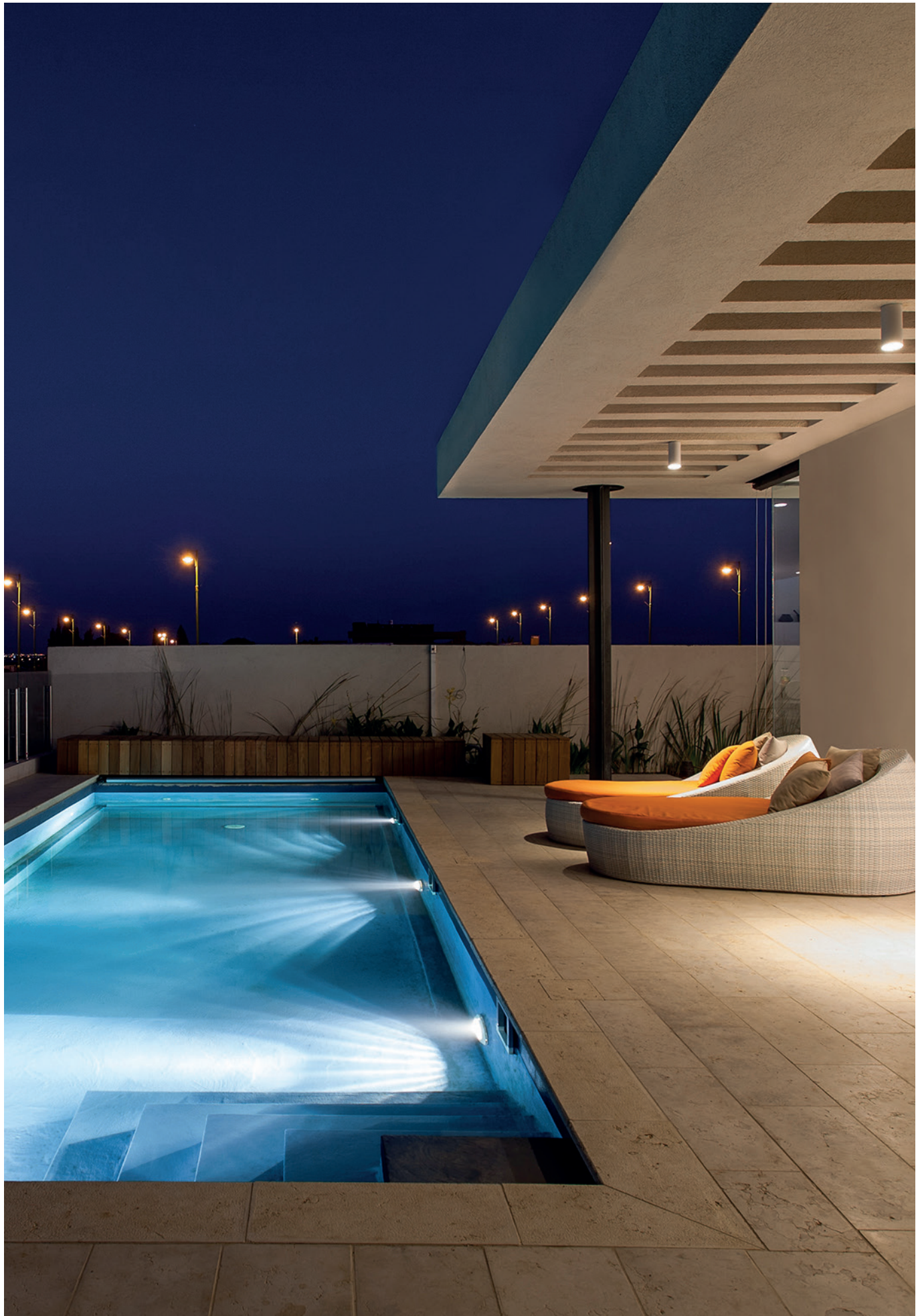



LUZ 1

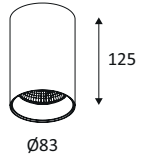
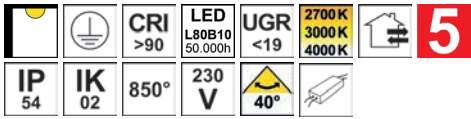

- Plafonnier pour éclairage extérieur.
- 2700K, 3000K ou 4000K au choix via un interrupteur dans le luminaire.
- Diffuseur en verre.
- Convertisseur non dimmable intégré dans l'appareil.

LUZ 1	COULEUR	MATIÈRE	P	T°	LED LUMEN	SYSTEM LUMEN	α	€
OU48905	■ NOIR MAT	ALUMINIUM	15W	2700K 3000K 4000K	1590Lm (4000K)	945Lm (4000K)	40°	101,00
OU48930	■ BLANC MAT	ALUMINIUM	15W	2700K 3000K 4000K	1590Lm (4000K)	1035Lm (4000K)	40°	101,00



NOIR MAT



BLANC MAT

LUZ 2

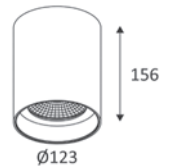
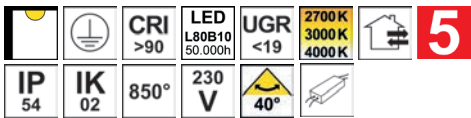

- Plafonnier pour éclairage extérieur.
- 2700K, 3000K ou 4000K au choix via un interrupteur dans le luminaire.
- Diffuseur en verre.
- Convertisseur non dimmable intégré dans l'appareil.

LUZ 2	COULEUR	MATIÈRE	P	T°	LED LUMEN	SYSTEM LUMEN	α	€
OU49005	■ NOIR MAT	ALUMINIUM	20W	2700K 3000K 4000K	1930Lm (4000K)	1475Lm (4000K)	40°	131,00
OU49030	■ BLANC MAT	ALUMINIUM	20W	2700K 3000K 4000K	1930Lm (4000K)	1485Lm (4000K)	40°	131,00



NOIR MAT



BLANC MAT

FARO 1

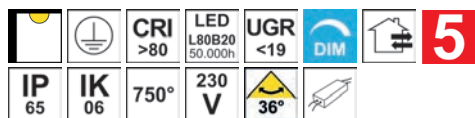

- Plafonnier pour éclairage intérieur et extérieur.
- Diffuseur en verre trempé clair.
- Avec entrée et sortie de câble.
- Convertisseur dimmable intégré dans l'appareil.
- Compatible avec variateur début et fin de phase.

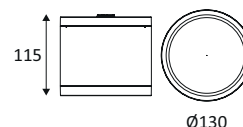

FARO 1	COULEUR	MATIÈRE	P	T°	LED LUMEN	SYSTEM LUMEN	α	€
OU447WW05	■ NOIR MAT	ALUMINIUM	24W	3000K	3150Lm	2595Lm	36°	180,00
OU447WW30	■ BLANC MAT	ALUMINIUM	24W	3000K	3150Lm	2605Lm	36°	180,00
OU447NW05	■ NOIR MAT	ALUMINIUM	24W	4000K	3200Lm	2770Lm	36°	180,00
OU447NW30	■ BLANC MAT	ALUMINIUM	24W	4000K	3200Lm	2750Lm	36°	180,00



NOIR MAT



BLANC MAT

FARO 2

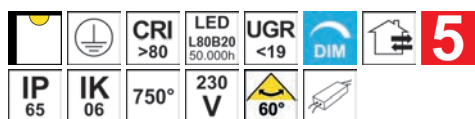

- Plafonnier pour éclairage intérieur et extérieur.
- Diffuseur en verre trempé clair.
- Avec entrée et sortie de câble.
- Convertisseur dimmable intégré dans l'appareil.
- Compatible avec variateur début et fin de phase.

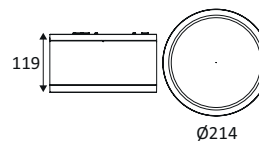

FARO 2	COULEUR	MATIÈRE	P	T°	LED LUMEN	SYSTEM LUMEN	α	€
OU448WW05	■ NOIR MAT	ALUMINIUM	34W	3000K	4350Lm	3760Lm	60°	286,00
OU448WW30	■ BLANC MAT	ALUMINIUM	34W	3000K	4350Lm	3865Lm	60°	286,00
OU448NW05	■ NOIR MAT	ALUMINIUM	34W	4000K	4360Lm	3940Lm	60°	286,00
OU448NW30	■ BLANC MAT	ALUMINIUM	34W	4000K	4360Lm	3785Lm	60°	286,00



NOIR MAT



BLANC MAT



FARO 1



ASPI 1 SENSOR PLUS

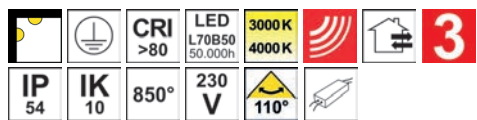

- Applique murale ou plafonnier.
- 3000K ou 4000K au choix via un interrupteur dans le luminaire.
- Avec détecteur HF 360° (plafond) 150° (mur), zone de détection réglable max. 12m de diamètre.
- Diffuseur en polycarbonate opalin.
- Convertisseur non dimmable intégré dans l'appareil.



ASPI 1 SENSOR PLUS	COULEUR	MATIÈRE	P	T°	LED LUMEN	SYSTEM LUMEN	α	€
OU440NW24	■ ANTHRACITE	FONTE D'ALUMINIUM	30W	3000K 4000K	3000Lm (4000K)	2080Lm (4000K)	110°	193,00
OU440NW30	■ BLANC MAT	FONTE D'ALUMINIUM	30W	3000K 4000K	3000Lm (4000K)	2080Lm (4000K)	110°	193,00



ANTHRACITE

BLANC MAT





ASPI 2 SENSOR PLUS

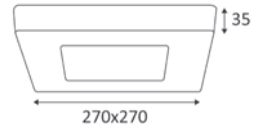
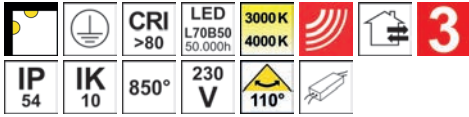

- Applique murale ou plafonnier.
- 3000K ou 4000K au choix via un interrupteur dans le luminaire.
- Avec détecteur HF 360° (plafond) 150° (mur), zone de détection réglable max. 12m de diamètre.
- Diffuseur en polycarbonate opalin.
- Convertisseur non dimmable intégré dans l'appareil.

ASPI 2 SENSOR PLUS	COULEUR	MATIÈRE	P	T°	LED LUMEN	SYSTEM LUMEN	α	€
OU441NW24	■ ANTHRACITE	FONTE D'ALUMINIUM	30W	3000K 4000K	3000Lm (4000K)	2080Lm (4000K)	110°	193,00
OU441NW30	■ BLANC MAT	FONTE D'ALUMINIUM	30W	3000K 4000K	3000Lm (4000K)	2080Lm (4000K)	110°	193,00



ANTHRACITE

BLANC MAT



INDIGO

LIGHTING



PROJECTEURS



Guide comparatif des Projecteurs

Quel luminaire correspond à votre projet ?

Utilisez les diagrammes ci-dessous pour choisir le luminaire adapté. La hauteur dont vous disposez et le niveau d'éclairage souhaité vous permettent de déterminer la puissance et la largeur de faisceau du luminaire à sélectionner. Référez-vous aux hauteurs indiquées dans les tableaux ci-dessous : chacune précise le diamètre d'éclairage obtenu et vous renseigne l'entraxe optimal entre les luminaires.

INDY 1 - (50 Lux)

Une seule référence offre trois niveaux de puissance.

FL100WW05

3000 K 

65 W

FL100WW05

80 W

FL100WW05

125 W

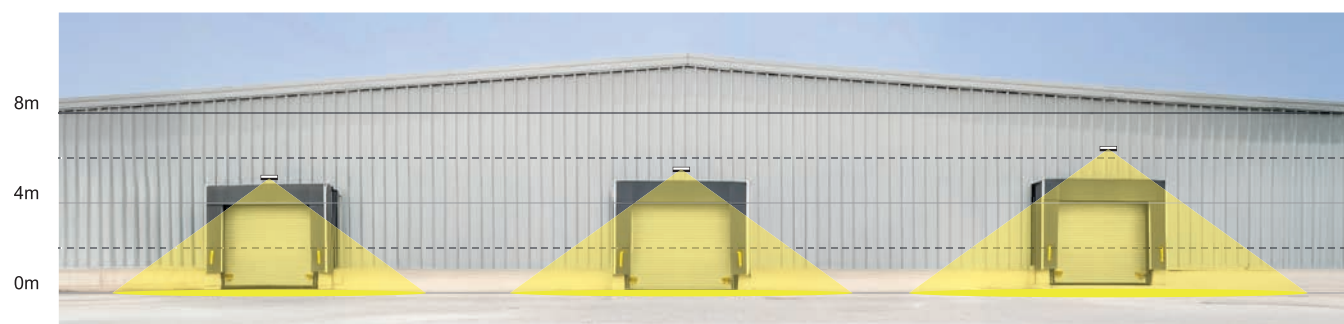

Ø 14m @ 5,1m		Ø 15,3m @ 5,6m		Ø 17,8m @ 6,5m																																																					
	<table border="1"> <thead> <tr><th>h (m)</th><th>LUX</th><th>Ø (m)</th></tr> </thead> <tbody> <tr><td>2</td><td>325</td><td>5,5</td></tr> <tr><td>4</td><td>80</td><td>11</td></tr> <tr><td>6</td><td>36</td><td>16,5</td></tr> <tr><td>8</td><td>20</td><td>22</td></tr> <tr><td>10</td><td>13</td><td>27,5</td></tr> </tbody> </table>	h (m)	LUX	Ø (m)	2	325	5,5	4	80	11	6	36	16,5	8	20	22	10	13	27,5	<table border="1"> <thead> <tr><th>h (m)</th><th>LUX</th><th>Ø (m)</th></tr> </thead> <tbody> <tr><td>2</td><td>385</td><td>5,5</td></tr> <tr><td>4</td><td>95</td><td>11</td></tr> <tr><td>6</td><td>43</td><td>16,5</td></tr> <tr><td>8</td><td>24</td><td>22</td></tr> <tr><td>10</td><td>15</td><td>27,5</td></tr> </tbody> </table>	h (m)	LUX	Ø (m)	2	385	5,5	4	95	11	6	43	16,5	8	24	22	10	15	27,5	<table border="1"> <thead> <tr><th>h (m)</th><th>LUX</th><th>Ø (m)</th></tr> </thead> <tbody> <tr><td>2</td><td>535</td><td>5,5</td></tr> <tr><td>4</td><td>135</td><td>11</td></tr> <tr><td>6</td><td>60</td><td>16,5</td></tr> <tr><td>8</td><td>34</td><td>22</td></tr> <tr><td>10</td><td>22</td><td>27,5</td></tr> </tbody> </table>	h (m)	LUX	Ø (m)	2	535	5,5	4	135	11	6	60	16,5	8	34	22	10	22	27,5
h (m)	LUX	Ø (m)																																																							
2	325	5,5																																																							
4	80	11																																																							
6	36	16,5																																																							
8	20	22																																																							
10	13	27,5																																																							
h (m)	LUX	Ø (m)																																																							
2	385	5,5																																																							
4	95	11																																																							
6	43	16,5																																																							
8	24	22																																																							
10	15	27,5																																																							
h (m)	LUX	Ø (m)																																																							
2	535	5,5																																																							
4	135	11																																																							
6	60	16,5																																																							
8	34	22																																																							
10	22	27,5																																																							

FL100NW05

4000 K 

65 W

FL100NW05

80 W

FL100NW05

125 W

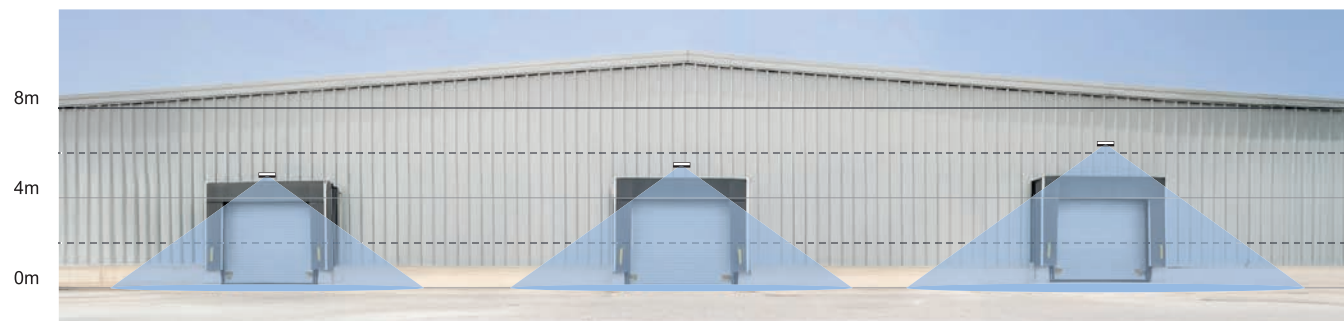

Ø 14,1m @ 4,9m		Ø 15,3m @ 5,3m		Ø 18m @ 6,3m																																																					
	<table border="1"> <thead> <tr><th>h (m)</th><th>LUX</th><th>Ø (m)</th></tr> </thead> <tbody> <tr><td>2</td><td>296</td><td>5,8</td></tr> <tr><td>4</td><td>74</td><td>11,5</td></tr> <tr><td>6</td><td>33</td><td>17,5</td></tr> <tr><td>8</td><td>18</td><td>23</td></tr> <tr><td>10</td><td>12</td><td>29</td></tr> </tbody> </table>	h (m)	LUX	Ø (m)	2	296	5,8	4	74	11,5	6	33	17,5	8	18	23	10	12	29	<table border="1"> <thead> <tr><th>h (m)</th><th>LUX</th><th>Ø (m)</th></tr> </thead> <tbody> <tr><td>2</td><td>350</td><td>5,8</td></tr> <tr><td>4</td><td>88</td><td>11,5</td></tr> <tr><td>6</td><td>39</td><td>17,5</td></tr> <tr><td>8</td><td>22</td><td>23</td></tr> <tr><td>10</td><td>14</td><td>29</td></tr> </tbody> </table>	h (m)	LUX	Ø (m)	2	350	5,8	4	88	11,5	6	39	17,5	8	22	23	10	14	29	<table border="1"> <thead> <tr><th>h (m)</th><th>LUX</th><th>Ø (m)</th></tr> </thead> <tbody> <tr><td>2</td><td>492</td><td>5,7</td></tr> <tr><td>4</td><td>123</td><td>11,5</td></tr> <tr><td>6</td><td>55</td><td>17,5</td></tr> <tr><td>8</td><td>31</td><td>23</td></tr> <tr><td>10</td><td>19</td><td>29</td></tr> </tbody> </table>	h (m)	LUX	Ø (m)	2	492	5,7	4	123	11,5	6	55	17,5	8	31	23	10	19	29
h (m)	LUX	Ø (m)																																																							
2	296	5,8																																																							
4	74	11,5																																																							
6	33	17,5																																																							
8	18	23																																																							
10	12	29																																																							
h (m)	LUX	Ø (m)																																																							
2	350	5,8																																																							
4	88	11,5																																																							
6	39	17,5																																																							
8	22	23																																																							
10	14	29																																																							
h (m)	LUX	Ø (m)																																																							
2	492	5,7																																																							
4	123	11,5																																																							
6	55	17,5																																																							
8	31	23																																																							
10	19	29																																																							



INDY 2 - (50 Lux)

Une seule référence offre trois niveaux de puissance.

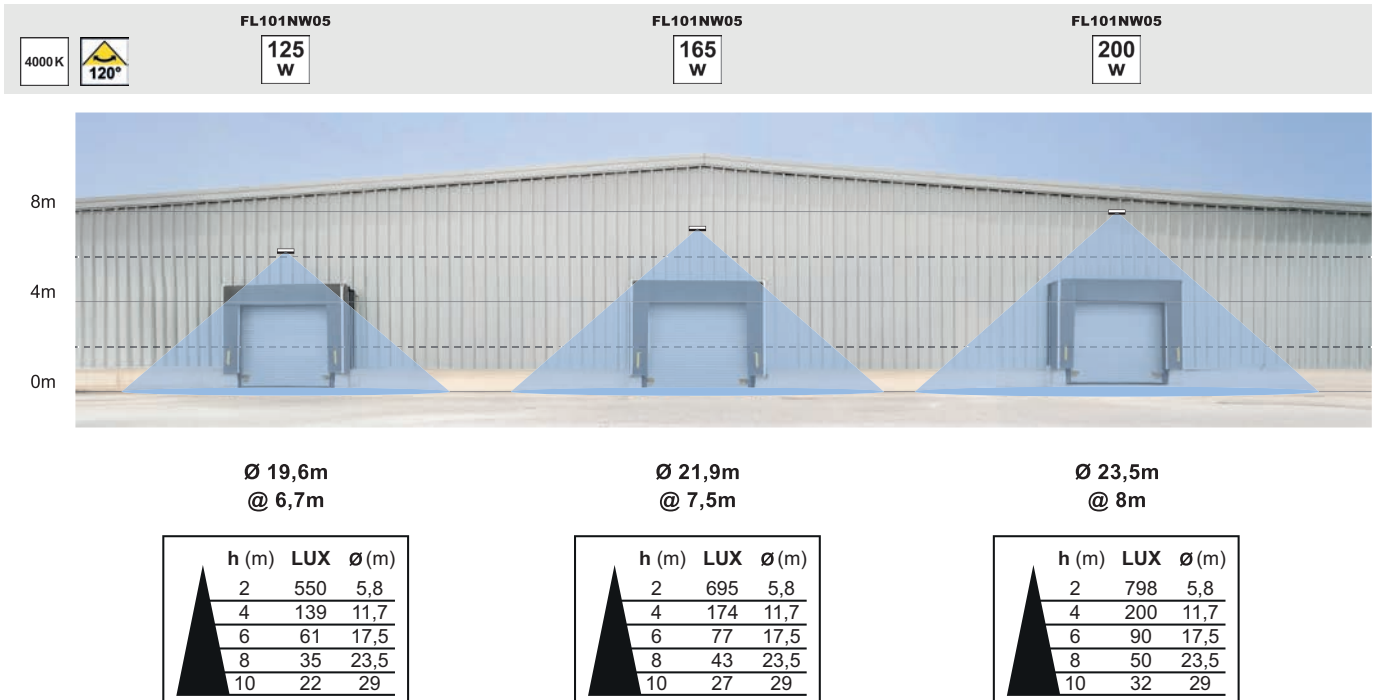
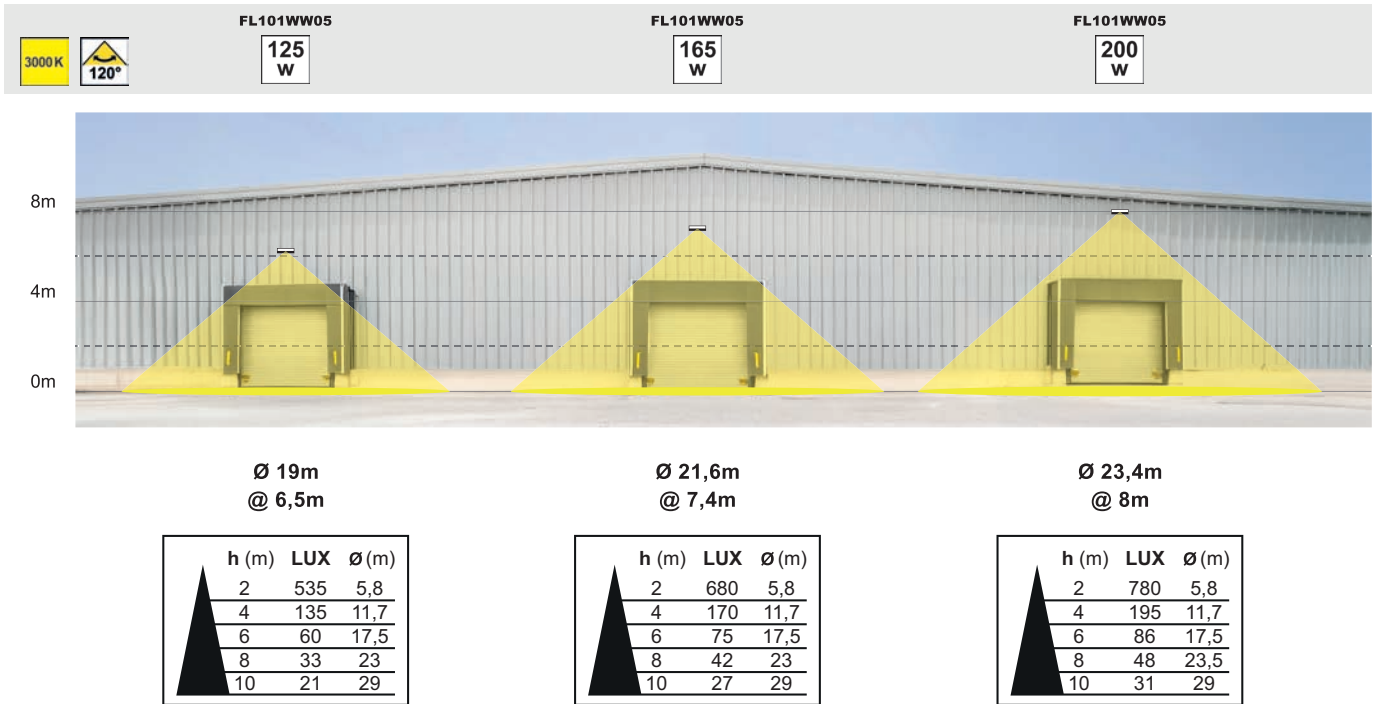

RAYPRO 14

Faisceau extensif pour les faibles hauteurs.

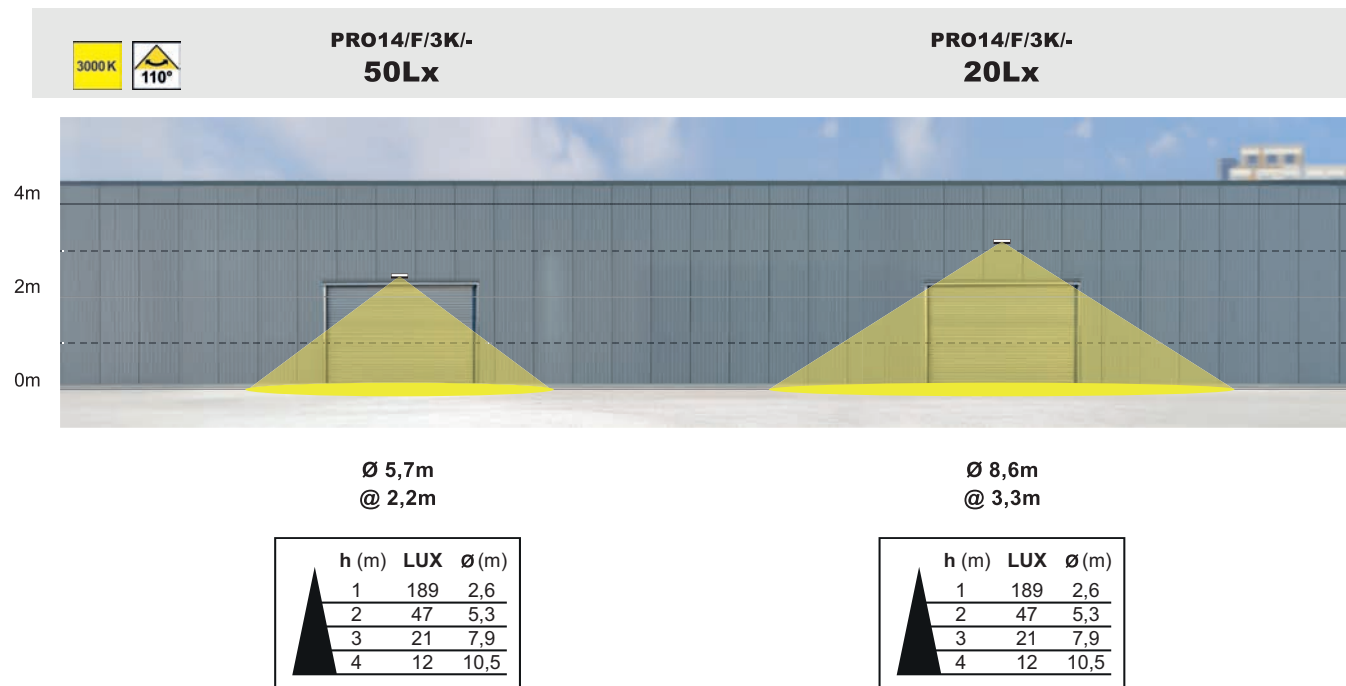

RAYPRO 32 & RAYPRO 50 (50 Lux)

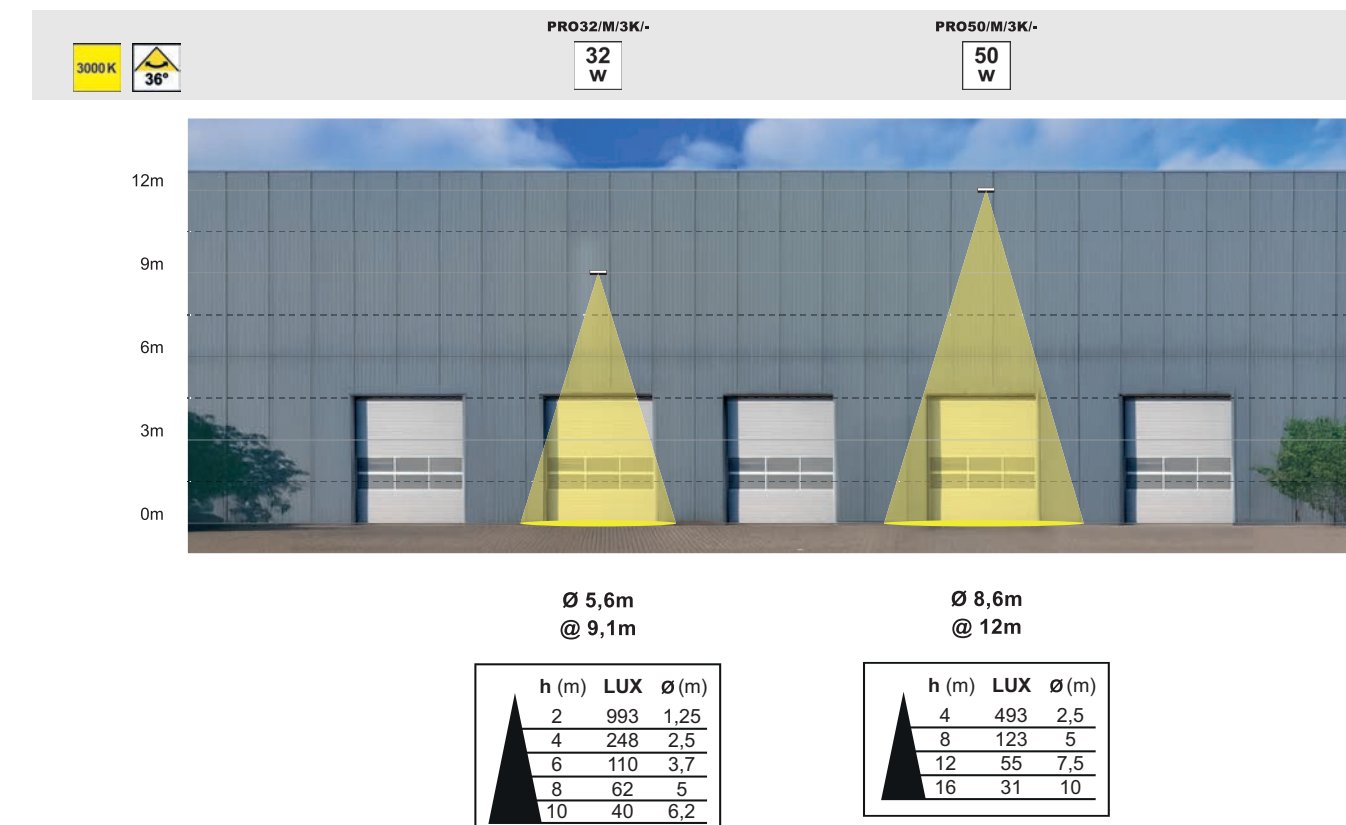

Faisceau intensif pour les grandes hauteurs.





RAYPRO 32A & RAYPRO 50A (50 Lux)

Faisceau asymétrique.





PRO32/AS/3K/-

32
W

PRO50/AS/3K/-

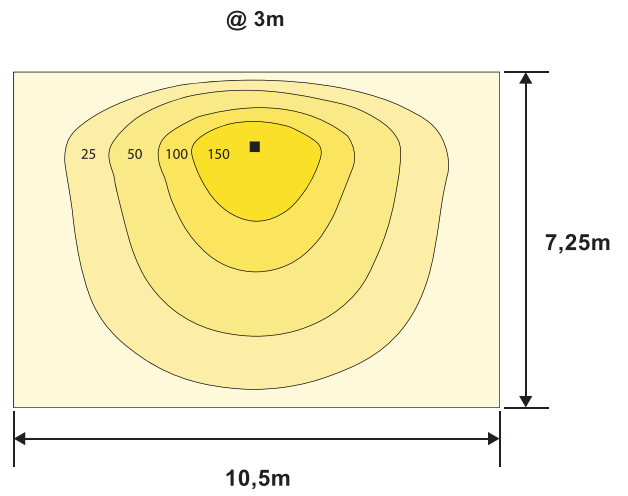
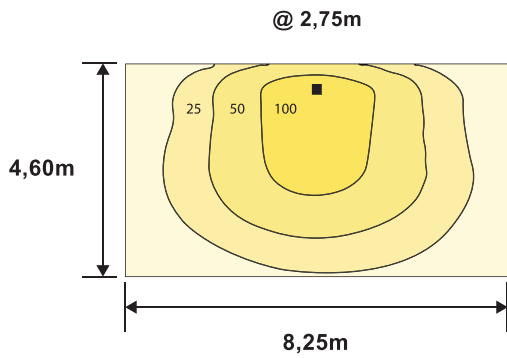
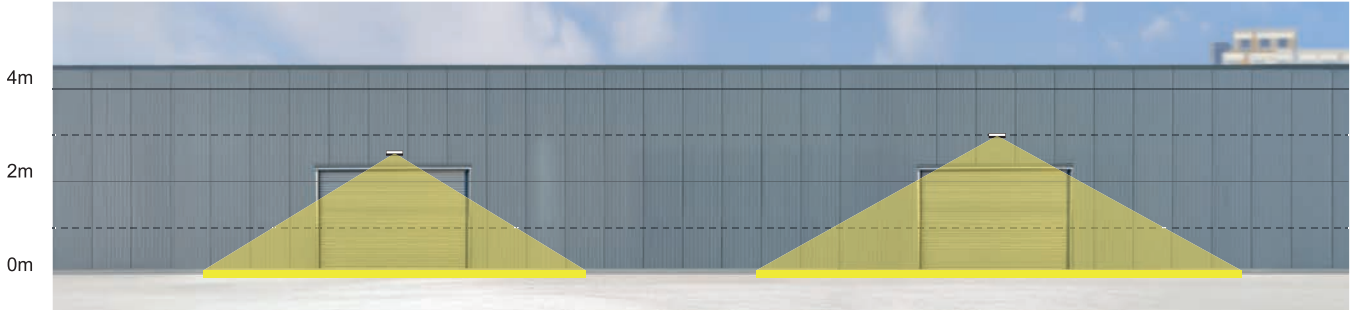
50
W



h (m)	LUX	Ø (m)
2	63	5 x 2,8
4	16	10 x 5,6
6	7	15 x 8,4
8	4	20 x 11,2
10	3	25 x 14

h (m)	LUX	Ø (m)
2	94	5,3 x 3,1
4	24	10,6 x 6,2
6	10	16 x 9,4
8	6	21,3 x 12,5
10	4	26,6 x 15,6

CURTIS PLUS

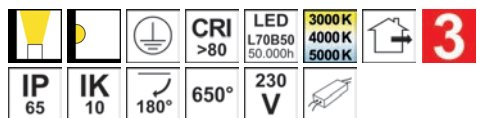

- Projecteur pour éclairage extérieur.
- 3000K, 4000K ou 5000K au choix via un interrupteur à l'arrière du luminaire.
- Diffuseur en polycarbonate.
- Livré avec 0.50m de câble.
- Convertisseur non dimmable intégré dans l'appareil.



CURTIS PLUS	COULEUR	MATIÈRE	P	T°	L(MM)	LED LUMEN	SYSTEM LUMEN	α	€	
OU47024	■ ANTHRACITE	FONTE D'ALUMINIUM	15W	3000K 4000K 5000K	147	1700Lm (4000K)	1340Lm (4000K)	120°	33,00	
OU47124	■ ANTHRACITE	FONTE D'ALUMINIUM	30W	3000K 4000K 5000K	178	3500Lm (4000K)	2910Lm (4000K)	120°	53,00	
OU47224	■ ANTHRACITE	FONTE D'ALUMINIUM	50W	3000K 4000K 5000K	208	5850Lm (4000K)	4225Lm (4000K)	120°	72,00	
OU47324	■ ANTHRACITE	FONTE D'ALUMINIUM	70W	3000K 4000K 5000K	260	8000Lm (4000K)	6435Lm (4000K)	120°	99,00	
ACCESSOIRES	COULEUR	MATIÈRE	DESCRIPTION						€	
OU17505	NOIR	FONTE D'ALUMINIUM	CURTIS PLUS 15W PIQUET OPTIONNEL							13,00
OU48405			CONNECTEUR 2PIN IP68							11,00
OU48505			CONNECTEUR 3PIN IP68							30,00





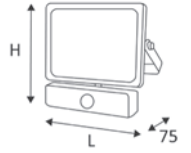
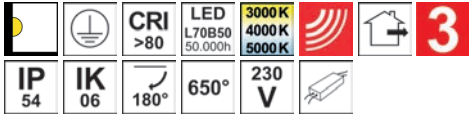

CURTIS SENSOR PLUS



- Projecteur pour éclairage extérieur.
- 3000K, 4000K ou 5000K au choix via un interrupteur à l'arrière du luminaire.
- Diffuseur en polycarbonate.
- Livré avec 0.50m de câble.
- Avec détecteur orientable IR 120°, zone de détection réglable max. 8m.
- Convertisseur non dimmable intégré dans l'appareil.

CURTIS SENSOR PLUS	COULEUR	MATIÈRE	P	T°	L(MM)	LED LUMEN	SYSTEM LUMEN	α	€
OU47424	■ ANTHRACITE	FONTE D'ALUMINIUM	15W	3000K 4000K 5000K	147	1700Lm (4000K)	1340Lm (4000K)	120°	55,00
OU47524	■ ANTHRACITE	FONTE D'ALUMINIUM	30W	3000K 4000K 5000K	178	3500Lm (4000K)	2910Lm (4000K)	120°	72,00
OU47624	■ ANTHRACITE	FONTE D'ALUMINIUM	50W	3000K 4000K 5000K	208	5850Lm (4000K)	4225Lm (4000K)	120°	86,00
ACCESSOIRES	DESCRIPTION								€
OU48405	CONNECTEUR 2PIN IP68								11,00
OU48505	CONNECTEUR 3PIN IP68								30,00



INDY 1

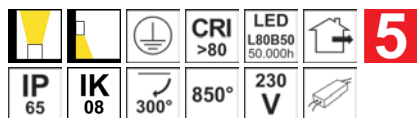

- Projecteur pour éclairage extérieur.
- Multi-puissance : 65, 80 ou 125W au choix via un interrupteur à l'arrière du luminaire.
- Diffuseur en verre trempé dépoli.
- Livré avec 1.00m de câble.
- Convertisseur non dimmable intégré dans l'appareil.

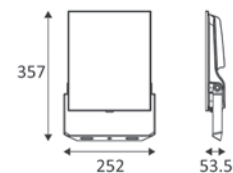

INDY 1	COULEUR	MATIÈRE	P	T°	LED LUMEN	SYSTEM LUMEN	α	€
FL100WW05	NOIR	FONTE D'ALUMINIUM	65 - 80 - 125W	3000K	12000Lm (65W) 14500Lm (80W) 19750Lm (125W)	10075Lm 11920Lm 16450Lm	120°	166,00
FL100NW05	NOIR	FONTE D'ALUMINIUM	65 - 80 - 125W	4000K	12500Lm (65W) 14750Lm (80W) 20500Lm (125W)	10310Lm 12230Lm 17145Lm	120°	166,00
ACCESSOIRES	DESCRIPTION							€
OU48405	CONNECTEUR 2PIN IP68							11,00
OU48505	CONNECTOR 3PIN IP68							30,00



INDY 1 A

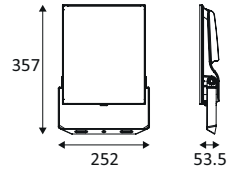
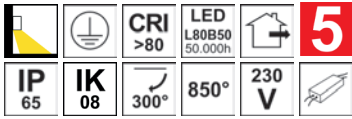

- Projecteur pour éclairage extérieur.
- Multi-puissance : 65, 80 ou 125W au choix via un interrupteur à l'arrière du luminaire.
- Diffuseur en verre trempé clair.
- Faisceau asymétrique.
- Livré avec 1.00m de câble.
- Convertisseur non dimmable intégré dans l'appareil.

INDY 1 A	COULEUR	MATIÈRE	P	T°	LED LUMEN	SYSTEM LUMEN	€
FL102WW05	NOIR	FONTE D'ALUMINIUM	65 - 80 - 125W	3000K	11500Lm (65W) 13750Lm (80W) 18750Lm (125W)	9625Lm 11365Lm 15525Lm	175,00
FL102NW05	NOIR	FONTE D'ALUMINIUM	65 - 80 - 125W	4000K	12500Lm (65W) 14500Lm (80W) 19500Lm (125W)	10370Lm 12025Lm 16275Lm	175,00
ACCESSOIRES	DESCRIPTION						€
OU48405	CONNECTEUR 2PIN IP68						11,00
OU48505	CONNECTOR 3PIN IP68						30,00



INDY 2

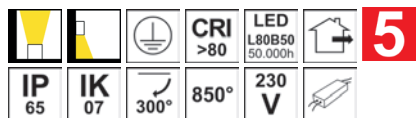

- Projecteur pour éclairage extérieur.
- Multi-puissance : 125, 165 ou 200W au choix via un interrupteur à l'arrière du luminaire.
- Diffuseur en verre trempé dépoli.
- Livré avec 1.00m de câble.
- Convertisseur non dimmable intégré dans l'appareil.

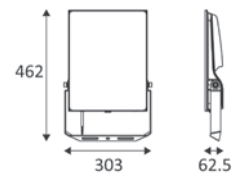

INDY 2	COULEUR	MATIÈRE	P	T°	LED LUMEN	SYSTEM LUMEN	α	€
FL101WW05	NOIR	FONTE D'ALUMINIUM	125 - 165 - 200W	3000K	22500Lm (125W) 28500Lm (165W) 33000Lm (200W)	18785Lm 23780Lm 27385Lm	120°	219,00
FL101NW05	NOIR	FONTE D'ALUMINIUM	125 - 165 - 200W	4000K	23500Lm (125W) 29500Lm (165W) 33750Lm (200W)	19470Lm 24395Lm 28055Lm	120°	219,00
ACCESSOIRES		DESCRIPTION			€			
OU48405		CONNECTEUR 2PIN IP68			11,00			
OU48505		CONNECTOR 3PIN IP68			30,00			





INDY 2 A

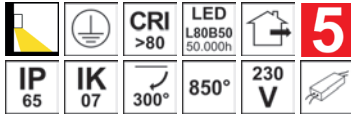

- Projecteur pour éclairage extérieur.
- Multi-puissance : 125, 165 ou 200W au choix via un interrupteur à l'arrière du luminaire.
- Diffuseur en verre trempé clair.
- Faisceau asymétrique.
- Livré avec 1.00m de câble.
- Convertisseur non dimmable intégré dans l'appareil.

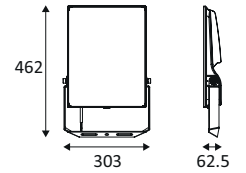

INDY 2 A	COULEUR	MATIÈRE	P	T°	LED LUMEN	SYSTEM LUMEN	€
FL103WW05	NOIR	FONTE D'ALUMINIUM	125 - 165 - 200W	3000K	20000Lm (125W) 25500Lm (165W) 31000Lm (200W)	16575Lm 21220Lm 25695Lm	236,00
FL103NW05	NOIR	FONTE D'ALUMINIUM	125 - 165 - 200W	4000K	22250Lm (125W) 27000Lm (165W) 31000Lm (200W)	18440Lm 22355Lm 25720Lm	236,00
ACCESSOIRES	DESCRIPTION						€
OU48405	CONNECTEUR 2PIN IP68					11,00	
OU48505	CONNECTOR 3PIN IP68					30,00	

RAYPRO 14

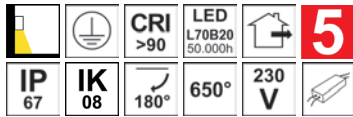

- Projecteur pour éclairage extérieur.
- Diffuseur en verre sérigraphié noir.
- Livré avec 1.50m de câble (HO5RN-F 3x0.75mm²).
- Convertisseur non dimmable intégré dans l'appareil.

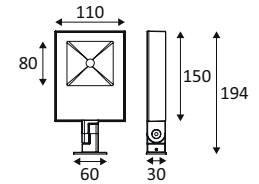

RAYPRO 14	COULEUR	MATIÈRE	P	T°	LED LUMEN	SYSTEM LUMEN	α	€
PRO14/F/3K/A	■ ANTHRACITE	FONTE D'ALUMINIUM	14W	3000K	1700Lm	1610Lm	110°	113,00
PRO14/F/3K/G	■ GRIS MAT	FONTE D'ALUMINIUM	14W	3000K	1700Lm	1610Lm	110°	113,00
PRO14/F/3K/W	■ BLANC MAT	FONTE D'ALUMINIUM	14W	3000K	1700Lm	1610Lm	110°	113,00



ANTHRACITE



GRIS MAT



BLANC MAT

RAYPRO 32

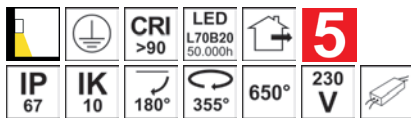

- Projecteur pour éclairage extérieur.
- Diffuseur en verre sérigraphié noir.
- Livré avec 1.50m de câble (HO5RN-F 3x0.75mm²).
- Convertisseur non dimmable intégré dans l'appareil.

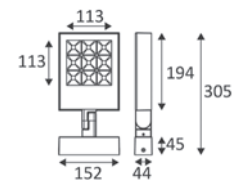

RAYPRO 32	COULEUR	MATIÈRE	P	T°	LED LUMEN	SYSTEM LUMEN	α	€
PRO32/M/3K/A	■ ANTHRACITE	FONTE D'ALUMINIUM	32W	3000K	3200Lm	2435Lm	36°	242,00
PRO32/M/3K/G	■ GRIS MAT	FONTE D'ALUMINIUM	32W	3000K	3200Lm	2435Lm	36°	242,00
PRO32/M/3K/W	■ BLANC MAT	FONTE D'ALUMINIUM	32W	3000K	3200Lm	2435Lm	36°	242,00

ACCESSOIRES	COULEUR	MATIÈRE	DESCRIPTION	L(MM)	€
POLE/PRO/A	NEW	ANTHRACITE	ALUMINIUM	TETE DE FIXATION POUR POTEAU DIAM. 60MM	80,00
POLE/PRO/G	NEW	GRIS MAT	ALUMINIUM	TETE DE FIXATION POUR POTEAU DIAM. 60MM	80,00
POLE/PRO/W	NEW	BLANC MAT	ALUMINIUM	TETE DE FIXATION POUR POTEAU DIAM. 60MM	80,00
BASE/PRO/A	NEW	ANTHRACITE	ALUMINIUM	EQUERRE DE FIXATION POUR POTEAU DIAM. 60MM & 76MM	45,00
BASE/PRO/G	NEW	GRIS MAT	ALUMINIUM	EQUERRE DE FIXATION POUR POTEAU DIAM. 60MM & 76MM	45,00
BASE/PRO/W	NEW	BLANC MAT	ALUMINIUM	EQUERRE DE FIXATION POUR POTEAU DIAM. 60MM & 76MM	45,00

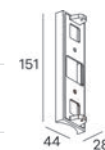
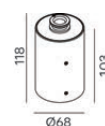

ANTHRACITE



GRIS MAT



BLANC MAT



RAYPRO 32 A

IP 67	IK 10	180°	355°	650°	230 V

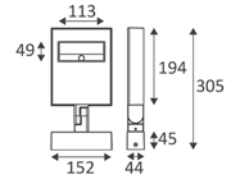

- Projecteur pour éclairage extérieur.
- Diffuseur en verre sérigraphié noir.
- Faisceau asymétrique.
- Livré avec 1.50m de câble (HO5RN-F 3x0.75mm²).
- Convertisseur non dimmable intégré dans l'appareil.

RAYPRO 32 A	COULEUR	MATIÈRE	P	T°	LED LUMEN	SYSTEM LUMEN	€
PRO32/AS/3K/A	ANTHRACITE	FORTE D'ALUMINIUM	32W	3000K	3300Lm	2335Lm	223,00
PRO32/AS/3K/G	GRIS MAT	FORTE D'ALUMINIUM	32W	3000K	3300Lm	2335Lm	223,00
PRO32/AS/3K/W	BLANC MAT	FORTE D'ALUMINIUM	32W	3000K	3300Lm	2335Lm	223,00

ACCESSOIRES	COULEUR	MATIÈRE	DESCRIPTION	L(MM)	€
POLE/PRO/A	NEW ANTHRACITE	ALUMINIUM	TETE DE FIXATION POUR POTEAU DIAM. 60MM		80,00
POLE/PRO/G	NEW GRIS MAT	ALUMINIUM	TETE DE FIXATION POUR POTEAU DIAM. 60MM		80,00
POLE/PRO/W	NEW BLANC MAT	ALUMINIUM	TETE DE FIXATION POUR POTEAU DIAM. 60MM		80,00
BASE/PRO/A	NEW ANTHRACITE	ALUMINIUM	EQUERRE DE FIXATION POUR POTEAU DIAM. 60MM & 76MM		45,00
BASE/PRO/G	NEW GRIS MAT	ALUMINIUM	EQUERRE DE FIXATION POUR POTEAU DIAM. 60MM & 76MM		45,00
BASE/PRO/W	NEW BLANC MAT	ALUMINIUM	EQUERRE DE FIXATION POUR POTEAU DIAM. 60MM & 76MM		45,00



ANTHRACITE GRIS MAT BLANC MAT



RAYPRO 50

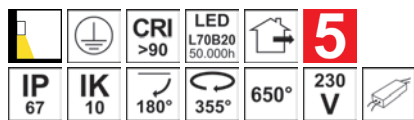

- Projecteur pour éclairage extérieur.
- Diffuseur en verre sérigraphié noir.
- Livré avec 1.50m de câble (HO5RN-F 3x0.75mm²).
- Convertisseur non dimmable intégré dans l'appareil.

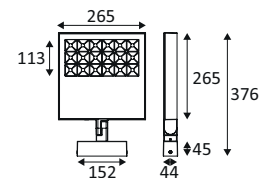

RAYPRO 50	COULEUR	MATIÈRE	P	T°	LED LUMEN	SYSTEM LUMEN	α	€
PRO50/M/3K/A	■ ANTHRACITE	FONTE D'ALUMINIUM	50W	3000K	5400Lm	4120Lm	36°	308,00
PRO50/M/3K/G	■ GRIS MAT	FONTE D'ALUMINIUM	50W	3000K	5400Lm	4120Lm	36°	308,00
PRO50/M/3K/W	■ BLANC MAT	FONTE D'ALUMINIUM	50W	3000K	5400Lm	4120Lm	36°	308,00

ACCESSOIRES	COULEUR	MATIÈRE	DESCRIPTION	L(MM)	€
POLE/PRO/A	NEW	ANTHRACITE	ALUMINIUM	TETE DE FIXATION POUR POTEAU DIAM. 60MM	80,00
POLE/PRO/G	NEW	GRIS MAT	ALUMINIUM	TETE DE FIXATION POUR POTEAU DIAM. 60MM	80,00
POLE/PRO/W	NEW	BLANC MAT	ALUMINIUM	TETE DE FIXATION POUR POTEAU DIAM. 60MM	80,00
BASE/PRO/A	NEW	ANTHRACITE	ALUMINIUM	EQUERRE DE FIXATION POUR POTEAU DIAM. 60MM & 76MM	45,00
BASE/PRO/G	NEW	GRIS MAT	ALUMINIUM	EQUERRE DE FIXATION POUR POTEAU DIAM. 60MM & 76MM	45,00
BASE/PRO/W	NEW	BLANC MAT	ALUMINIUM	EQUERRE DE FIXATION POUR POTEAU DIAM. 60MM & 76MM	45,00



ANTHRACITE

GRIS MAT

BLANC MAT



RAYPRO 50 A

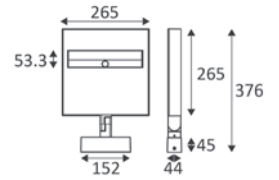
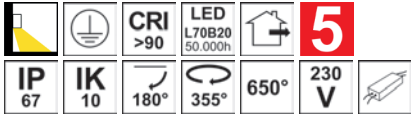

- Projecteur pour éclairage extérieur.
- Diffuseur en verre sérigraphié noir.
- Faisceau asymétrique.
- Livré avec 1.50m de câble (HO5RN-F 3x0.75mm²).
- Convertisseur non dimmable intégré dans l'appareil.

RAYPRO 50 A	COULEUR	MATIÈRE	P	T°	LED LUMEN	SYSTEM LUMEN	€
PRO50/AS/3K/A	ANTHRACITE	FONTE D'ALUMINIUM	50W	3000K	5650Lm	4490Lm	288,00
PRO50/AS/3K/G	GRIS MAT	FONTE D'ALUMINIUM	50W	3000K	5650Lm	4490Lm	288,00
PRO50/AS/3K/W	BLANC MAT	FONTE D'ALUMINIUM	50W	3000K	5650Lm	4490Lm	288,00

ACCESSOIRES	COULEUR	MATIÈRE	DESCRIPTION	L(MM)	€
POLE/PRO/A	NEW ANTHRACITE	ALUMINIUM	TETE DE FIXATION POUR POTEAU DIAM. 60MM		80,00
POLE/PRO/G	NEW GRIS MAT	ALUMINIUM	TETE DE FIXATION POUR POTEAU DIAM. 60MM		80,00
POLE/PRO/W	NEW BLANC MAT	ALUMINIUM	TETE DE FIXATION POUR POTEAU DIAM. 60MM		80,00
BASE/PRO/A	NEW ANTHRACITE	ALUMINIUM	EQUERRE DE FIXATION POUR POTEAU DIAM. 60MM & 76MM		45,00
BASE/PRO/G	NEW GRIS MAT	ALUMINIUM	EQUERRE DE FIXATION POUR POTEAU DIAM. 60MM & 76MM		45,00
BASE/PRO/W	NEW BLANC MAT	ALUMINIUM	EQUERRE DE FIXATION POUR POTEAU DIAM. 60MM & 76MM		45,00



ANTHRACITE

GRIS MAT

BLANC MAT



INDIGO

LIGHTING



SPOTS



ADA 1 RX



- Spot encastré rond orientable.
- 2700K, 3000K ou 4000K au choix via un interrupteur à l'arrière du luminaire.
- Fixation par ressorts.
- Convertisseur non dimmable déporté fourni.

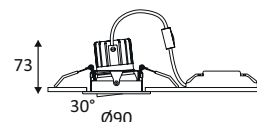

ADA 1 RX	COULEUR	MATIÈRE	P	T°	LED LUMEN	SYSTEM LUMEN	α	€
OU49805	■ NOIR MAT	ALUMINIUM	9W	2700K 3000K 4000K	1100Lm (4000K)	775Lm (4000K)	38°	89,00
OU49830	■ BLANC MAT	ALUMINIUM	9W	2700K 3000K 4000K	1100Lm (4000K)	775Lm (4000K)	38°	89,00



NOIR MAT



BLANC MAT

ADA 2 RX



- Spot encastré rond orientable.
- 2700K, 3000K ou 4000K au choix via un interrupteur à l'arrière du luminaire.
- Fixation par ressorts.
- Convertisseur non dimmable déporté fourni.

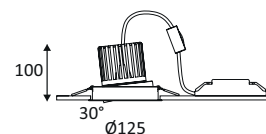

ADA 2 RX	COULEUR	MATIÈRE	P	T°	LED LUMEN	SYSTEM LUMEN	α	€
OU49905	■ NOIR MAT	ALUMINIUM	18W	2700K 3000K 4000K	2225Lm (4000K)	1585Lm (4000K)	38°	134,00
OU49930	■ BLANC MAT	ALUMINIUM	18W	2700K 3000K 4000K	2225Lm (4000K)	1585Lm (4000K)	38°	134,00



NOIR MAT



BLANC MAT



ADA 1 RX



AL3012 RD OUT



- Spot encastré rond fixe.
- Avec traitement de surface pour une meilleure résistance.
- Réflecteur basse luminance.
- Fixation par ressorts.
- Convertisseur dimmable déporté fourni.
- Compatible avec variateur début et fin de phase.

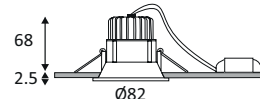

AL3012 RD OUT	COULEUR	MATIÈRE	P	T°	LED LUMEN	SYSTEM LUMEN	α	€
OU328WW24	■ ANTHRACITE	FONTE D'ALUMINIUM	9W	3000K	940Lm	760Lm	38°	81,00
OU328WW30	■ BLANC MAT	FONTE D'ALUMINIUM	9W	3000K	940Lm	760Lm	38°	81,00



ANTHRACITE



BLANC MAT





NEW

H2 PRO EXTREME CSP

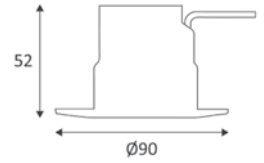
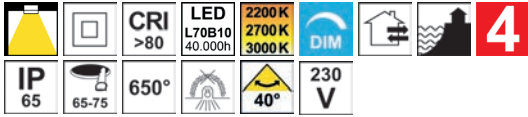

- Spot encastré rond fixe 3 en 1.
- 2200K, 2700K ou 3000K au choix via un interrupteur à l'arrière du luminaire.
- IP65 du dessus et du dessous.
- Avec protection contre la corrosion et le brouillard salin, convient aux zones côtières.
- Fixation par ressorts.
- Ne nécessite pas de convertisseur.
- Dimmable, compatible avec variateur début et fin de phase.

H2 PRO EXTREME CSP	COULEUR	MATIÈRE	P	T°	LED LUMEN	SYSTEM LUMEN	α	€
H2EXT1B	NEW NOIR MAT	ALUMINIUM + COMPOSITE	5W	2200K 2700K 3000K	600Lm (3000K)	560Lm (3000K)	40°	35,00
H2EXT1A	NEW ANTHRACITE	ALUMINIUM + COMPOSITE	5W	2200K 2700K 3000K	600Lm (3000K)	560Lm (3000K)	40°	35,00
H2EXT1W	NEW BLANC MAT	ALUMINIUM + COMPOSITE	5W	2200K 2700K 3000K	600Lm (3000K)	560Lm (3000K)	40°	35,00



NOIR MAT



ANTHRACITE



BLANC MAT



INDIGO

LIGHTING



SOLAIRES



RAMA W

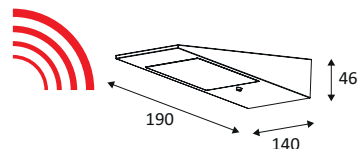
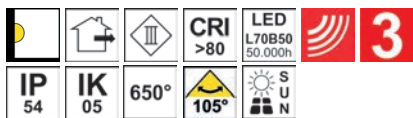

- Applique avec cellules solaires et batterie rechargeable.
- Fonctionne uniquement quand la luminosité est inférieure à 20 Lux.
- Avec interrupteur et détecteur HF 180°, distance de détection max. 6m.
- Deux niveaux d'éclairage après détection, 195 lumens pendant 30 secondes puis 30 lumens avec une autonomie de 15 heures.
- Temps de charge 6 à 8 heures en plein ensoleillement.

RAMA W	COULEUR	MATIÈRE	P	T°	LED LUMEN	SYSTEM LUMEN	α	€
OU464WW24	■ ANTHRACITE	FORTE D'ALUMINIUM	2W	3000K	550lm	195lm	105°	159,00

RAMA P

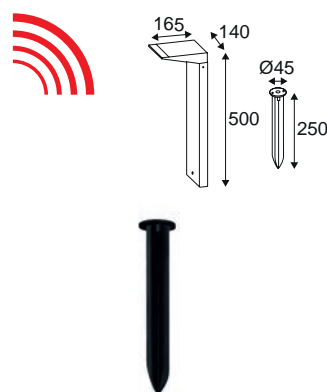
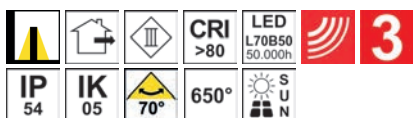

- Borne avec cellules solaires et batterie rechargeable.
- Fonctionne uniquement quand la luminosité est inférieure à 20 Lux.
- Avec interrupteur et détecteur HF 180°, distance de détection max. 6m.
- Deux niveaux d'éclairage après détection, 140 lumens pendant 30 secondes puis 20 lumens avec une autonomie de 15 heures.
- Temps de charge 6 à 8 heures en plein ensoleillement.
- Piquet à enterrer inclus.

RAMA P	COULEUR	MATIÈRE	P	T°	LED LUMEN	SYSTEM LUMEN	α	€
OU348WW24	■ ANTHRACITE	FORTE D'ALUMINIUM	2W	3000K	550lm	140lm	70°	172,00
OU348NW24	■ ANTHRACITE	FORTE D'ALUMINIUM	2W	4000K	600lm	140lm	70°	172,00





KALA

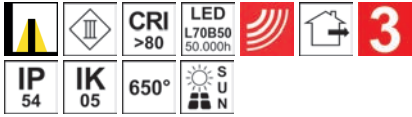

- Borne carrée avec cellules solaires et batterie rechargeable.
- Fonctionne uniquement quand la luminosité est inférieure à 20 Lux.
- Avec interrupteur et détecteur IR 120°, rayon de détection max. 6m.
- Deux niveaux d'éclairage après détection, 225 lumens pendant 45 secondes puis 35 lumens avec une autonomie de 15 heures.
- Temps de charge 6 à 8 heures en plein ensoleillement.
- Piquet à enterrer inclus.

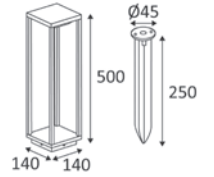

KALA	COULEUR	MATIÈRE	P	T°	LED LUMEN	SYSTEM LUMEN	€
OU342NW24	■ ANTHRACITE	FONTE D'ALUMINIUM	2W	4000K	600Lm	225Lm	200,00



ACCESSOIRES

SOURCES, DOUILLES ET CÂBLES

ALIMENTATIONS

GESTION D'ÉCLAIRAGE

BOÎTES DE RACCORDEMENT
ET CONNECTEURS IP

INDIGO



LIGHTING

SOURCES, DOUILLES ET CÂBLES



MODU LED



- Module LED d'un diamètre identique à une PAR16 230V ou MR16 12V.
- Compatible avec KASA et ALA1013.
- Convertisseur dimmable déporté fourni.
- Compatible avec variateur début et fin de phase.
- Durée de vie : 30.000h.

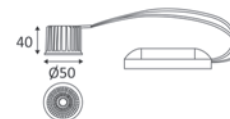

MODU LED	LED	T°	LED LUMEN	SYSTEM LUMEN	α	€
LED9W500DWW	9W	3000K	940Lm	830Lm	38°	49,00

SUP 08 AUTO



- Etrier avec douille GU10.
- Double bornier automatique.
- Ne nécessite aucun outil.

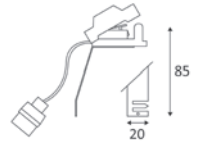

SUP 08 AUTO	SOQUET	WATT MAX	€
SUP08	GU10	50W	5,00

WCR275BLACK



- Câble en caoutchouc 2 fils.
- H05RN-F 2x0,75mm².
- Fourni au mètre.
- Limité à une utilisation en basse tension.
- Adapté à une utilisation en extérieur.



WCR275BLACK	L(MM)	€
WCR275BLACK	1000	8,00

INDIGO



LIGHTING

ALIMENTATIONS

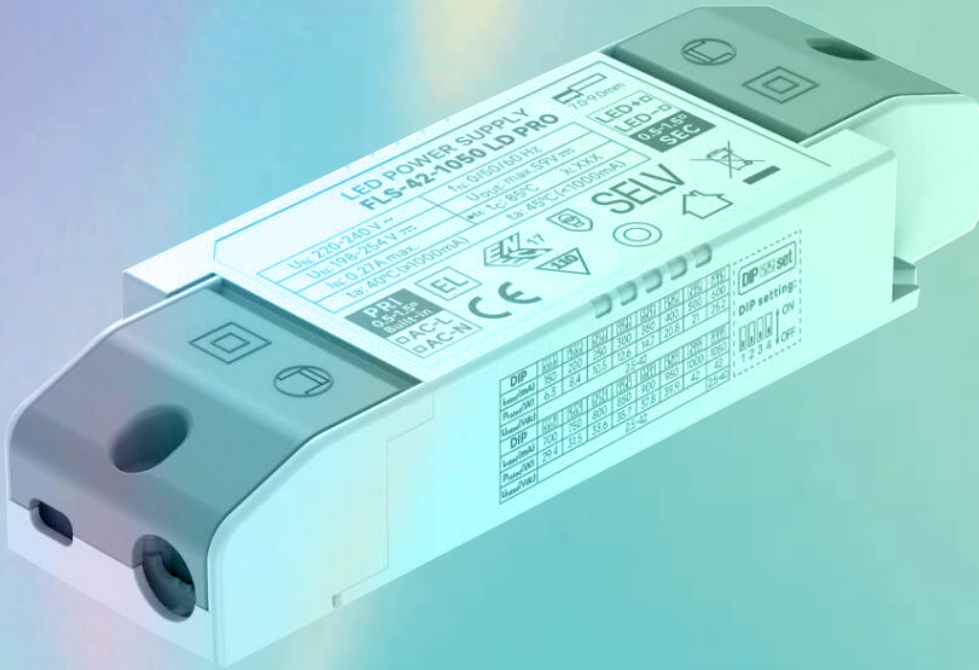









CONVERTISSEURS CC NON DIMMABLES

	CODE	IP	WATT MAX	PRI	SEC	INPUTS	OUTPUTS	L(mm)	l(mm)	H(mm)	€
5	 CD155	IP20	2-3W	230V AC - 50HZ	DC 350mA	1	1	86	32	23	25,00
2	 CD170	IP20	5,5-7W	230V AC - 50HZ	DC 350mA	1	1	71	36	22	17,00
5	 PSIP3509W	IP65	1-9W	230V AC - 50HZ	DC 350mA	1	1	149	37	24	48,00
2	 CD114	IP67	2-18W	230V AC - 50HZ	DC 350mA	1	1	140	30	22	41,00
5	 PSIP35018W	IP65	9-18W	230V AC - 50HZ	DC 350mA	1	1	149	37	24	63,00
5	 CD172	IP65	2-4W	230V AC - 50HZ	DC 700mA	1	1	50	27,5	21	14,00
5	 PSIP70018W	IP65	2-18W	230V AC - 50HZ	DC 700mA	1	1	149	37	24	62,00
2	 CD105	IP67	9-35W	230V AC - 50HZ	DC 700mA	1	1	148	40	30	86,00
5	 PSIP70036W	IP65	18-36W	230V AC - 50HZ	DC 700mA	1	1	162	41	24	81,00
5	 DRV150700	IP20	6-30W	230V AC - 50HZ	DC 150-250-350-500-700mA	1	1	132	43	22	45,00































CONVERTISSEURS CC DIMMABLES COUPURE DE PHASE





























	CODE	IP	WATT MAX	PRI	SEC	INPUTS	OUTPUTS	L(mm)	l(mm)	H(mm)	€
3	 CD102	IP20	6,5-13,5W	230V AC - 50HZ	DC 350mA	1	1	95	53	25	46,00
3	 CD112	IP20	9-18W	230V AC - 50HZ	DC 350mA	1	1	95	53	25	48,00
3	 CD104	IP20	9-18W	230V AC - 50HZ	DC 500mA	1	1	95	53	30	49,00
3	 CD147	IP20	5-10W	230V AC - 50HZ	DC 700mA	1	1	95	53	25	33,00
3	 CD125	IP20	19-35W	230V AC - 50HZ	DC 700mA	1	2	153	54	36	75,00
5	 DRV350700TD	IP20	14-20W	230V AC - 50HZ	DC 350-500-700mA	1	1	150	43	29	70,00



CONVERTISSEURS CC DIMMABLES 1-10V - DALI - PUSH-DIM

	CODE	IP	WATT MAX	PRI	SEC	IN	OUT	L(mm)	l(mm)	H(mm)		€
8	 CD123	IP20	3-18W	230V AC - 50HZ	DC 250mA	1	1	150	42,5	22		86,00
8	 CD124	IP20	3-18W	230V AC - 50HZ	DC 300mA	1	1	150	42,5	22		88,00
5	 PLDUNIDRIVE350MA	IP20	1-10W	230V AC - 50HZ	DC 350mA	1	1	103	67	22		107,00
5	 PSDIM350	IP20	1-18W	230V AC - 50HZ	DC 350mA	1	1	123	79	22		153,00
5	 PSDAL350M	IP20	1-18W	230V AC - 50HZ	DC 350mA	1	1	123	79	22	 	171,00
8	 CD140	IP20	3-18W	230V AC - 50HZ	DC 350mA	1	1	150	42,5	22		99,00
8	 CD116	IP20	3-18W	230V AC - 50HZ	DC 500mA	1	1	150	42,5	22		77,00
8	 CD126	IP20	4-27W	230V AC - 50HZ	DC 500mA	1	1	150	42,5	22		79,00
8	 CD148	IP20	3-18W	230V AC - 50HZ	DC 700mA	1	1	150	42,5	22		68,00
5	 PLDUNIDRIVE700MA	IP20	3-27W	230V AC - 50HZ	DC 700mA	1	1	103	67	22		97,00
7	 PSDIM700	IP20	3-50W	230V AC - 50HZ	DC 700mA	1	1	123	79	22		148,00
5	 PSDAL700M	IP20	3-50W	230V AC - 50HZ	DC 700mA	1	1	123	79	22	 	146,00
8	 CD122	IP20	9-55W	230V AC - 50HZ	DC 1050mA	1	1	103	67	22,5		151,00

CONVERTISSEURS CV NON DIMMABLES

	CODE	IP	WATT MAX	PRI - SEC	INPUTS	OUTPUTS	L(mm)	l(mm)	H(mm)	€
2	 CD171 	IP20	20W	230V AC - 12V DC	1	1	128	50	13	41,00
5	 CD173 	IP20	30W	230V AC - 24V DC	1	1	153	41,4	32	34,00
3	 CD158 	IP20	60W	230V AC - 24V DC	1	1	100	78	37	50,00
5	 CD174 	IP20	60W	230V AC - 24V DC	1	2	180	52	30	41,00
5	 CD175 	IP20	75W	230V AC - 24V DC	1	2	180	52	30	42,00
5	 CD178 	IP67	75W	230V AC - 24V DC	1	1	155	49	32	65,00
5	 CD179 	IP67	100W	230V AC - 24V DC	1	1	206	68,6	37	110,00
3	 CD150 	IP20	120W	230V AC - 24V DC	1	2	160	98	38	51,00
5	 CD176 	IP20	120W	230V AC - 24V DC	1	2	300	40	30	53,00
3	 CD159 	IP20	150W	230V AC - 24V DC	1	2	160	98	38	68,00
5	 CD180 	IP67	150W	230V AC - 24V DC	1	1	206	68,6	37	113,00
5	 CD177 	IP20	180W	230V AC - 24V DC	1	2	345	50	35	97,00
3	 CD151 	IP20	200W	230V AC - 24V DC	1	2	199	98	42	74,00
5	 CD181 	IP67	250W	230V AC - 24V DC	1	1	245,4	86,2	47,2	200,00



CONVERTISSEURS CV DIMMABLE COUPURE DE PHASE

	CODE	IP	WATT MAX	PRI - SEC	INPUTS	OUTPUTS	L(mm)	l(mm)	H(mm)	€
3	 CD153	IP20	75W	230V AC - 24V DC	1	2	295	40	32	227,00



CONVERTISSEURS CV DIMMABLE 0/1-10V - DALI - PUSH-DIM

	CODE	IP	WATT MAX	PRI	INPUTS	OUTPUTS	L(mm)	l(mm)	H(mm)	€
3	 CD154	IP20	200W	230V AC - 24V DC	1	2	310	60	45	270,00

INDIGO



LIGHTING

GESTION D'ÉCLAIRAGE

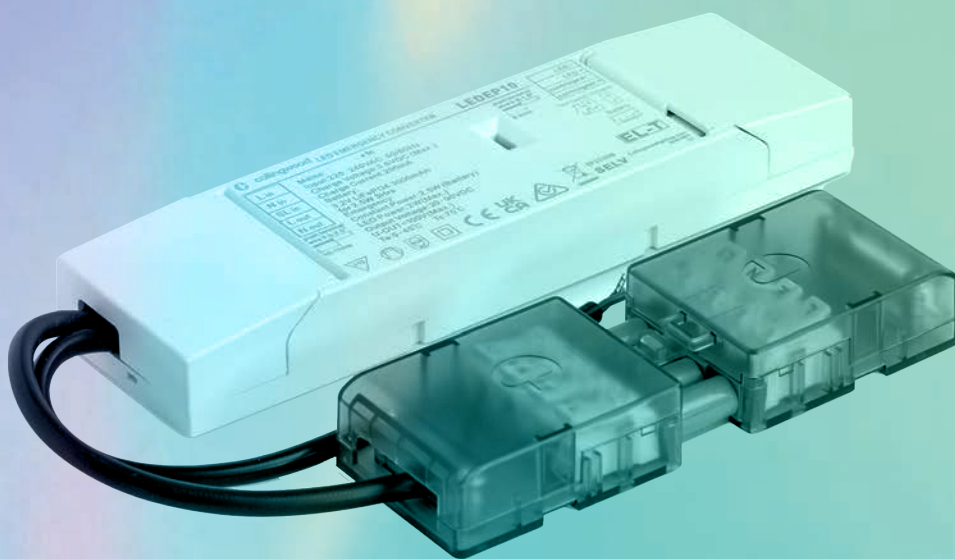

CD136

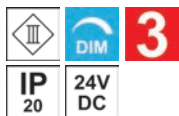

- Variateur tension constante à commander avec bouton poussoir ou télécommande.
- Convertisseur 24Vdc et télécommande à commander séparément.
- La télécommande permet de contrôler 4 zones séparément.
- Un variateur CD136 est nécessaire par zone à contrôler.

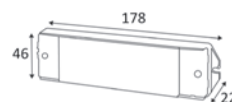

CD136	WATT MAX	PRI	SEC	INPUTS	OUTPUTS	L(MM)	l(mm)	H(mm)	€
CD136	4X120W	DC 24V	DC 24V	2	4	178	46	22	156,00
ACCESSOIRES		DESCRIPTION							€
CD14905	TELECOMMANDE RF								60,00

CD135



- Contrôleur RGB 24Vdc livré avec télécommande.
- Fonctions ON/OFF, pause, «mode», vitesse et intensité.
- Portée de la télécommande 25m.
- Convertisseur 24Vdc à commander séparément.

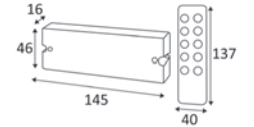

CD135	WATT MAX	PRI	SEC	INPUTS	L(MM)	l(mm)	H(mm)	€
CD13505	3X120W	DC 24V	DC 24V	2	145	46	16	89,00

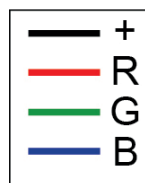
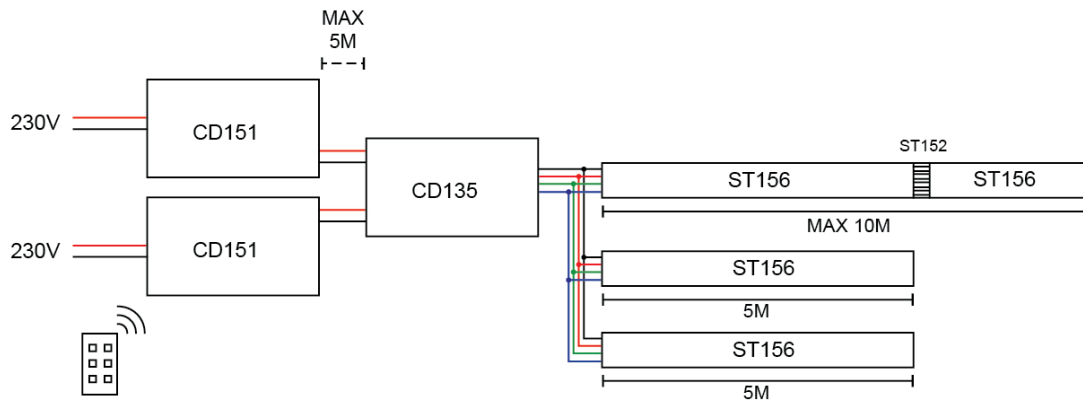
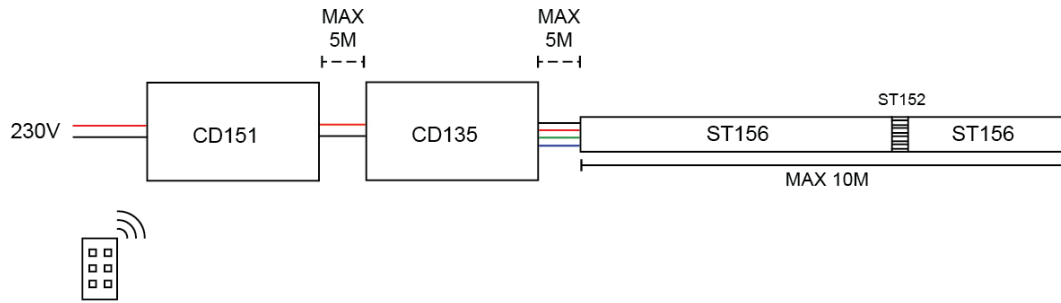



CD141

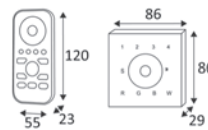
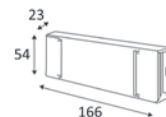

- Contrôleur RGB / RGB+W 24Vdc.
- Configuration «maître-esclave» suivant la position du switch.
- Convertisseur 24Vdc, télécommande ou panneau mural à commander séparément.
- Portée de la télécommande et du panneau mural 20m.



CD141	WATT MAX	PRI	SEC	INPUTS	L(MM)	l(mm)	H(mm)	€
CD141	4X120W	DC 24V	DC 24V	2	166	54	23	162,00
ACCESSOIRES		DESCRIPTION						€
CD15704	PANNEAU MURAL RF RGB+W 230V							183,00
CD16005	TELECOMMANDE RF RGB+W							115,00

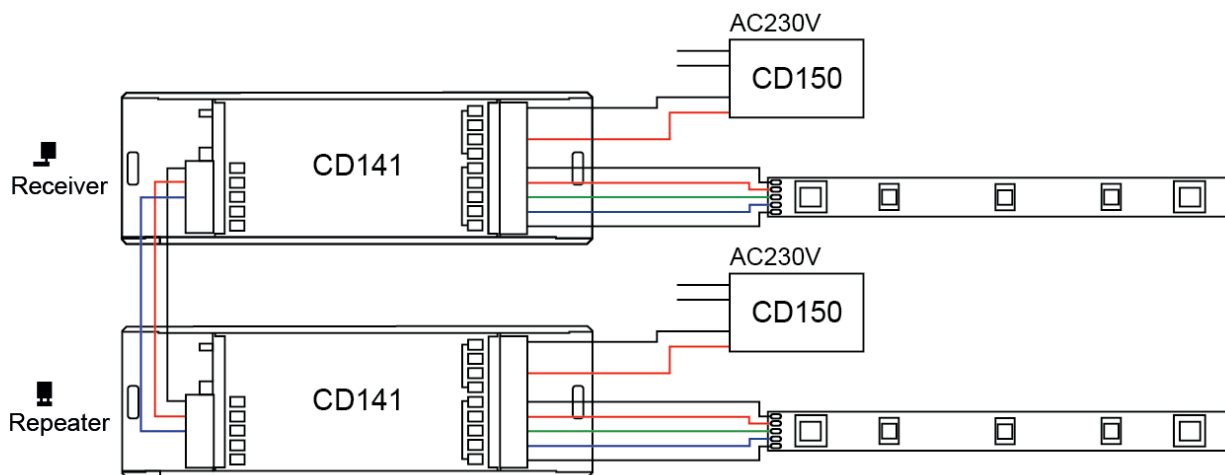

CD142



- Contrôleur blanc dynamique 24Vdc.
- Compatible avec bandeau LED ST132.
- Portée de la télécommande 25m.
- Convertisseur 24Vdc et télécommande à commander séparément.

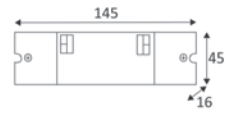

CD142	WATT MAX	PRI	SEC	INPUTS	L(MM)	l(mm)	H(mm)	€
CD142	2X120W	DC 24V	DC 24V	1	145	45	16	67,00
ACCESSOIRES		DESCRIPTION						€
CD14305		TELECOMMANDE RF						53,00

CD156



- Système de contrôle sans fil.
- Bluetooth.
- Commande via l'application CASAMBI.
- Contacts secs pour connecter un bouton poussoir.
- Possibilité de contrôler des bandeaux monochromes (dimming), RGB, RGB+W ou blanc dynamique.
- Convertisseur 24Vdc à commander séparément.

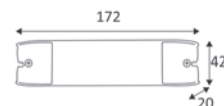

CD156	WATT MAX	PRI	SEC	INPUTS	OUTPUTS	L(MM)	l(mm)	H(mm)	€
CD156	240W	DC 24V	DC 24V	1	1	172	42	20	423,00

LEDEP10



- Kit d'éclairage de secours.
- Permet de convertir les luminaires compatibles en éclairage de secours.
- Test automatique (possibilité de test manuel via un bouton test fourni).
- Voyant bicolore rouge/vert indiquant le statut de l'installation.
- Autonomie minimale de 3 heures.
- Diamètre d'encastrement : 18mm (voyant LED), 7mm (bouton test).
- Connecteurs Plug & Play.
- Compatible avec les produits THEA, SOLIS et DOMINO.

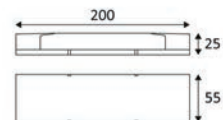

LEDEP10	WATT MAX	L(MM)	l(mm)	H(mm)	€
LEDEP10	2,5W	200	55	25	221,00

INDIGO



LIGHTING

BOÎTES DE RACCORDEMENT ET CONNECTEURS IP

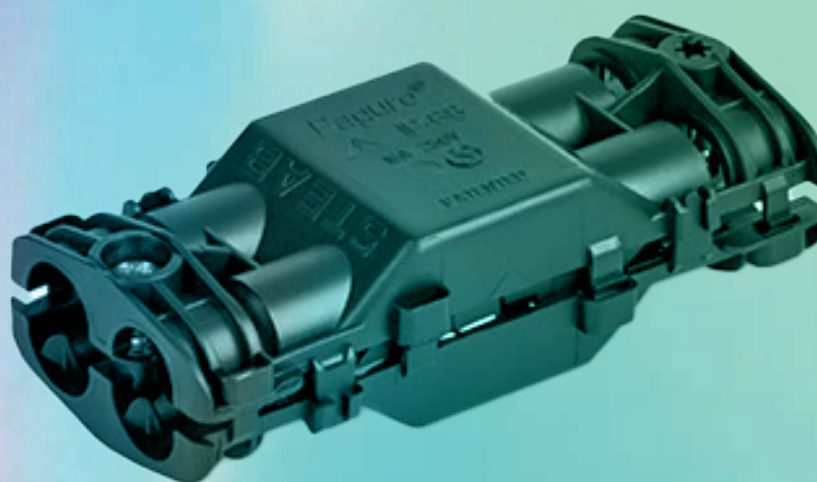

WC59



- Connecteur rapide étanche.
- Immergeable jusqu'à 9m.
- Doté d'une entrée et d'une sortie.
- Diamètre du câble compatible : 5 à 9mm. Conducteur de max 4mm².
- Tension maximum : 250VAC / 50VDC.
- Courant maximum : 10A.
- Compatible avec le câble WCR275BLACK.



WC59	L(MM)	€
WC59	125	77,00

JB1



- Boîte de raccordement étanche.
- Pour le montage en parallèle de produits en extérieur.
- Dotée d'une entrée et de trois sorties.
- Une sortie peut être raccordée à une autre boîte JB1.
- Diamètre du câble compatible : 5 à 6,5mm.
- Conducteur de max 1mm².
- Pour basse tension uniquement : max 30VDC.
- Courant maximum : 5A.



JB1	L(MM)	€
JB1	95	12,00

JB2



- Boîte de raccordement étanche.
- Pour le montage en série de produits en extérieur.
- Dotée d'une entrée et de trois sorties.
- Une sortie peut être raccordée à une autre boîte JB2.
- Diamètre du câble compatible : 5 à 6,5mm.
- Conducteur de max 1mm².
- Pour basse tension uniquement : max 48VDC.
- Courant maximum : 700mA.

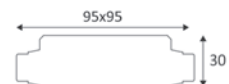

JB2	L(MM)	€
JB2	95	12,00

JB4



- Boîte de connexion étanche siliconée.
- Pour le montage en série de produits en extérieur.
- Dotée d'une entrée et de trois sorties.
- Diamètre du câble compatible : 6,5 à 12mm.
- Conducteur de max 1,5mm².
- Tension maximum : 120VDC.
- Courant maximum : 700mA.

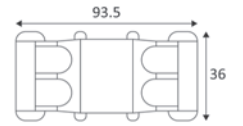

JB4	L(MM)	€
JB4	93,5	49,00

JB5



- Boîte de connexion étanche siliconée.
- Pour le montage en parallèle de produits en extérieur.
- Dotée d'une entrée et de trois sorties.
- Diamètre du câble compatible : 6,5 à 12mm.
- Conducteur de max 1,5mm².
- Tension maximum : 250VAC.
- Courant maximum : 16A.

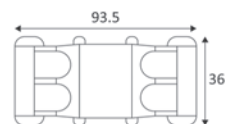

JB5	L(MM)	€
JB5	93,5	49,00

JB6



- Connecteur étanche siliconé.
- Pour connexion filaire continue en extérieur.
- Doté d'une entrée et d'une sortie.
- Diamètre du câble compatible : 4,8 à 6mm.
- Conducteur de max 0,75mm².
- Tension maximum : 250VAC.
- Courant maximum : 6A.

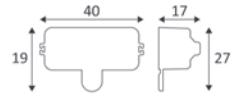
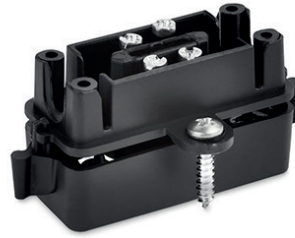

JB6	L(MM)	€
JB6	40	30,00

JB7



- Connecteur étanche 5 bornes à visser.
- Pour le montage de produits RGBW uniquement, en extérieur.
- Doté d'une entrée et d'une sortie.
- Diamètre du câble compatible : 7 à 10,5mm.
- Conducteur de max 4mm².
- Tension maximum : 24V.
- Courant maximum : 1,4A.



JB7	L(MM)	€
JB7	128	38,00

INDIGO



LIGHTING

PICTOGRAMMES

INDEX GÉNÉRAL

PICTOGRAMMES

	Usage intérieur.		Le produit ne peut pas être recouvert après montage, même par un isolant.
	Usage extérieur.		Le produit peut être recouvert après montage par un isolant déroulé.
	Usage intérieur et extérieur.		Le produit peut être recouvert après montage par un isolant déroulé ou soufflé.
	Montage au plafond en encastré uniquement.	IP 20	Protection contre la pénétration de corps supérieurs à 12mm. Sans protection contre l'eau.
	Montage au plafond en encastré uniquement.	IP 23	Protection contre les pénétrations des corps solides supérieurs à 12mm. Protection contre les chutes verticales de gouttes d'eau avec angle d'inclinaison de max. 60°.
	Montage au plafond uniquement.	IP 33	Protection contre les pénétrations des corps solides supérieurs à 2,5mm. Protection contre les chutes verticales de gouttes d'eau avec angle d'inclinaison de max. 60°.
	Montage sur un mur ou un plafond.	IP 40	Protection contre la pénétration des corps solides supérieurs à 1mm. Sans protection contre l'eau.
	Montage en suspension.	IP 44	Protection contre la pénétration des corps solides supérieurs à 1mm. Protection contre les projections d'eau.
	Montage en suspension.	IP 54	Protection contre les poussières et contre les projections d'eau.
	Montage sur un mur en encastré uniquement.	IP 55	Protection contre la poussière. Protection contre les jets d'eau.
	Montage sur un mur en encastré uniquement.	IP 56	Protection contre la poussière. Protection contre les jets d'eau.
	Montage sur un mur uniquement.	IP 65	Étanchéité aux poussières. Protection contre les jets d'eau.
	Montage sur un mur uniquement.	IP 66	Étanchéité aux poussières. Étanchéité aux jets d'eau puissants.
	Montage sur un mur uniquement.	IP 67	Étanche aux poussières. Étanche à l'immersion temporaire.
	Montage sur un mur uniquement.	IP 68	Totalement protégé contre les poussières. Protégé contre les effets prolongés de l'immersion sous pression à 2m.
	Montage sur un mur uniquement. Ce luminaire éclaire avec 2 zones d'éclairage.	IK 00	Pas de protection.
	Montage sur un mur uniquement. Ce luminaire éclaire avec 2 zones d'éclairage.	IK 01	Protection contre une énergie de choc de 0,15 Joule.
	Montage dans le sol en encastré uniquement.	IK 02	Protection contre une énergie de choc de 0,20 Joule.
	Montage dans le sol en encastré uniquement.	IK 03	Protection contre une énergie de choc de 0,35 Joule.
	Montage sur le sol en apparent uniquement.	IK 04	Protection contre une énergie de choc de 0,50 Joule.
	Montage sur le sol uniquement.	IK 05	Protection contre une énergie de choc de 0,70 Joule.
	Montage sur le sol uniquement.	IK 06	Protection contre une énergie de choc de 1 Joule.
	Montage sur le sol uniquement.	IK 07	Protection contre une énergie de choc de 2 Joules.
	Luminaire mobile.	IK 08	Protection contre une énergie de choc de 5 Joules.
	Produit à isolation principale qui comporte des dispositifs reliant l'ensemble de ses parties métalliques accessibles au conducteur de protection.	IK 09	Protection contre une énergie de choc de 10 Joules.
	Produit dont les parties accessibles sont séparées des parties actives par double isolation ou isolation renforcée.	IK 10	Protection contre une énergie de choc de 20 Joules.
	Produit alimenté sous une très basse tension de sécurité (T.B.T.S) qui n'excède pas 50V (valeur efficace en courant alternatif).	IK 11	Protection contre une énergie de choc de 50 Joules.
	Conforme à la réglementation thermique en vigueur (France).		Anti-vandale.

PICTOGRAMMES

	Inox 304. Nettoyer régulièrement avec un produit adapté pour éviter toute corrosion. Pas d'agent mordant ni de matériau abrasif.		Livré avec lampe(s).
	Inox 316. Nettoyer régulièrement avec un produit adapté pour éviter toute corrosion. Pas d'agent mordant ni de matériau abrasif.		Avec prise USB.
	Testé à 650°.		Batterie rechargeable via prise USB.
	Testé à 750°.		Avec détecteur de mouvement.
	Testé à 850°.		Avec cellules solaires.
	Indice de rendu des couleurs >70.		Dimmable, avec variateur intégré.
	Indice de rendu des couleurs >80.		Le produit est dimmable.
	Indice de rendu des couleurs >85.		Le produit est dimmable (0-10V).
	Indice de rendu des couleurs >90.		Le produit est dimmable (1-10V).
	Indice de rendu des couleurs >95.		Le produit est dimmable (entrée DALI).
	A connecter à un courant alternatif de 12V.		Le produit est dimmable (entrée DALI + push-dim).
	A connecter à un courant alternatif de 230V.		Température de couleur variable de 1800K à 3000K suivant l'intensité de dimming.
	A connecter à une alimentation Led en voltage constant de 12VDC.		Température de couleur variable de 2000K à 3000K suivant l'intensité de dimming.
	A connecter à une alimentation Led en voltage constant de 24VDC.		Température de couleur à sélectionner.
	A connecter à une alimentation Led en voltage constant de 48VDC.		Température de couleur à sélectionner.
	Luminaire équipé d'un module LED en 230V.		Température de couleur à sélectionner.
	Alimentation non incluse.		Température de couleur à sélectionner.
	Branchement en parallèle.		Température de couleur à sélectionner.
	Branchement en série.		Température de couleur à sélectionner.
	Avec prises 2P + T 16A max. 2x2000W.		Blanc dynamique (2700K-6000K).
	UGR inférieur à 19.		Changement de couleur RGB.
	Orientation verticale possible du luminaire pour un maximum de x°.		RGB + White.
	Orientation horizontale possible du luminaire pour un maximum de x°.		Durée de vie (maintien du flux lumineux L et taux de mortalité B).
	Percement rectangulaire pour l'insertion du luminaire. La longueur et la largeur à respecter sont citées dans la fiche technique et le manuel de montage (mm).		Garantie 2 ans.
	Diamètre de percement pour l'insertion du boîtier du luminaire (mm).		Garantie 3 ans.
	Hauteur de faux-plafond minimum pour y inclure le luminaire (mm).		Garantie 5 ans.
	Largeur de faisceau.		Garantie 7 ans.
	Faisceau ajustable.		Garantie 8 ans.

A

ABY 1 RD..... 76
 ABY 2 RD..... 76
 ABY 3 RD..... 77
 ADA 1 RX..... 532
 ADA 2 RX..... 532
 AIN3KCL..... 204
 AIN3KPL..... 226
 AL1014..... 64
 AL1014 RDX..... 64
 AL1014 RX..... 64
 AL1015 RX..... 65
 AL1016 RX..... 112
 AL2014 SDX..... 65
 AL3012 RD..... 74
 AL3012 RD OUT..... 534
 AL3012 RD WARM..... 74
 ALA1013..... 26
 ALA1013 RX GU10 AUTO..... 26
 ALA1013S..... 27
 ALA1013 SX GU10 AUTO..... 27
 ALBA R GU10..... 176
 ALBA S GU10..... 176
 ALEX RDX..... 60
 ALIS 1014 RDX..... 46
 ALLY 1 RDX..... 90
 ALLY 1 RX..... 90
 ALLY 2 RDX..... 91
 ALLY 2 RX..... 91
 ALLY 3 RDX..... 78
 ALLY 4 RDX..... 78
 ALMA R..... 488
 ALMA S..... 488
 ALTEA 1 GU10..... 467
 ALTEA 2 GU10..... 467
 ALTO 1 GU10..... 466
 ALTO 2 GU10..... 466
 AMONT..... 444
 ANDY..... 431
 APA RD-230..... 406
 ARCOLE..... 481
 ARRAS..... 320
 ARTSY..... 463
 ASPI 1 SENSOR PLUS..... 512
 ASPI 2 SENSOR PLUS..... 513
 AUREA 1 C..... 195
 AUREA 1 W..... 154
 AUREA 2 C..... 196
 AUREA 2 W..... 155
 AUREA 3 T..... 284
 AUREA 3 TP..... 285
 AUREA 3 W..... 156
 AUREA 4 W..... 157
 AUREA P..... 219
 AVI 1..... 454
 AVI 2..... 454

B

BALI R GU10..... 28
 BASIL 1 P..... 424
 BASIL 2 P..... 424
 BASIL 3 P..... 425
 BENS P..... 449
 BENS W..... 480
 BERN..... 319
 BIG APA RD-230..... 406
 BIG RODI A..... 413
 BIXBY..... 166
 BO1360A15..... 468
 BORA RD-230 EVO..... 52
 BORA RD EVO..... 54
 BORA RDH EVO..... 58
 BORA RDX-230 EVO..... 53
 BORA RDX EVO..... 56
 BORA SD EVO..... 55
 BORA SDX EVO..... 57
 BORU 1..... 345
 BORU 2..... 345

BORU 3..... 346
 BORU 4..... 346
 BP1..... 496
 BP1A..... 496
 BP2..... 498
 BP2A..... 498
 BRAMA 1..... 423
 BRAMA 2..... 423
 BRAVA RD-230..... 44
 BRAVA RDH-230..... 44
 BREST..... 445
 BRIKPRO 1..... 496
 BRIKPRO 1 A..... 496
 BRIKPRO 2..... 498
 BRIKPRO 2 A..... 498
 BU101..... 364
 BU102..... 364
 BU103..... 366
 BU104..... 366

C

CADIX..... 318
 CAIMAN QUICK CONNECT..... 374
 CAIMAN VERSA..... 373
 CAIQC..... 374
 CAIV..... 373
 CAPRI R 1 C..... 208
 CAPRI R 1 P..... 230
 CAPRI R 2 C..... 209
 CAPRI R 2 P..... 230
 CAPRI R 3 C..... 210
 CAPRI R 3 P..... 231
 CAPRI S 1 C..... 211
 CAPRI S 1 P..... 232
 CAPRI S 2 C..... 211
 CAPRI S 2 P..... 232
 CD102..... 550
 CD104..... 550
 CD105..... 550
 CD112..... 550
 CD114..... 550
 CD116..... 551
 CD122..... 551
 CD123..... 551
 CD124..... 551
 CD125..... 550
 CD126..... 551
 CD135..... 557
 CD135..... 557
 CD136..... 556
 CD136..... 556
 CD136..... 556
 CD140..... 551
 CD141..... 558
 CD141..... 558
 CD142..... 559
 CD142..... 559
 CD147..... 550
 CD148..... 551
 CD150..... 552
 CD151..... 552
 CD153..... 552
 CD154..... 552
 CD155..... 550
 CD156..... 560
 CD156..... 560
 CD158..... 552
 CD159..... 552
 CD170..... 550
 CD171..... 552
 CD172..... 550
 CD173..... 552
 CD174..... 552
 CD175..... 552
 CD176..... 552
 CD177..... 552
 CD178..... 552
 CD179..... 552
 CD180..... 552

CD181..... 552
 CHERA..... 487
 CL100..... 352
 CL101..... 354
 CL101..... 355
 CL108..... 353
 CL109..... 356
 CL109..... 357
 CLAC..... 198
 CLAC 1 MINI..... 197
 CLAC 2 MINI..... 197
 CLARA 1 RDX..... 88
 CLARA 2 RDX..... 88
 CLIC RDX..... 92
 CLIC RDX MINI..... 92
 COMO RX GU10..... 29
 COPE RD..... 68
 COSTE 1..... 473
 COSTE 2..... 473
 CURTIS PLUS..... 520
 CURTIS SENSOR PLUS..... 521
 CYCLO..... 456
 CYCLO SENSOR..... 456

D

DALMA T..... 334
 DANI..... 481
 DAX RD-230..... 104
 DEAN RDX PLUS..... 99
 DEBI RD..... 48
 DEBI RD-230..... 48
 DECO TRACK 48 L..... 326
 DECO TRACK 48 M..... 328
 DECO TRACK 48 S..... 330
 DEVI..... 462
 DISU 1..... 336
 DISU 2..... 337
 DM..... 134
 DMCSP..... 135
 DO102..... 111
 DO103..... 42
 DO104..... 42
 DO107..... 112
 DO108..... 65
 DO160..... 64
 DO164..... 67
 DO165..... 67
 DO171..... 74
 DO182..... 65
 DO197..... 32
 DO212..... 32
 DO221..... 75
 DO224..... 92
 DO225..... 198
 DO227..... 46
 DO241..... 37
 DO246..... 98
 DO263..... 202
 DO315..... 46
 DO330..... 74
 DO334..... 36
 DO337..... 38
 DO344..... 123
 DO346..... 124
 DO356..... 106
 DO357..... 106
 DO358..... 107
 DO365..... 92
 DO366..... 84
 DO430..... 48
 DO431..... 50
 DO442..... 66
 DO443..... 66
 DO444..... 86
 DO445..... 48
 DO446..... 50
 DO459..... 40

D

DO460 40
 DO461 76
 DO462 76
 DO464 77
 DO465 68
 DO466 68
 DO467 41
 DO468 36
 DO487 104
 DO488 122
 DO489 124
 DO490 98
 DO491 86
 DO495 84
 DO500 80
 DO501 72
 DO502 73
 DO507 90
 DO508 91
 DO509 96
 DO510 97
 DO513 28
 DO514 28
 DO515 87
 DO518 29
 DO520 52
 DO521 53
 DO526 99
 DO527 90
 DO528 91
 DO529 78
 DO530 78
 DO531 120
 DO532 120
 DO533 60
 DO534 88
 DO535 88
 DO536 104
 DO538 115
 DO539 116
 DO540 117
 DO541 118
 DO542 100
 DO543 100
 DO544 44
 DO545 44
 DO546 24
 DO547 24
 DO549 62
 DO550 62
 DO551 54
 DO552 56
 DO553 58
 DO554 55
 DO555 57
 DO560 94
 DO561 94
 DO564 70
 DOMINO 134
 DOMINO CSP 135
 DOTS 80
 DOTS C 214
 DW110R 140
 DW110S 140
 DW1120R 189
 DW1120S 189

E

EAZY 383
 EDDY RX 96
 EDGY 485
 ELBY S 472
 ELLA 167
 ELNE 1 440
 ELNE 2 440
 ELNE 4 441
 EPI RD 68
 EVA 62 R 189

EVA 62 S 189
 EVA 65R 140
 EVA 65S 140
 EVIA G9 148

F

FARO 1 510
 FARO 2 510
 FIJI R GU10 28
 FILI 1 RX-B 98
 FILI 1 RX GU10 AUTO 86
 FILI 5 RDX-B 98
 FILI 5 RX-B GU10 AUTO 86
 FILO P 452
 FINN P 447
 FINN W 474
 FL100 522
 FL101 524
 FL102 523
 FL103 525
 FOCAL 291
 FOCEA 1 SX PLUS 124
 FOCEA 2 SX 124
 FOCUS 291
 FOLD 1 168
 FOLD 2 168
 FOX 2 RD 111
 FULLA 163
 FURY S GU10 468

G

GL016 F II 401
 GL016 II 400
 GL018 C 391
 GL018C 391
 GL019 F II 395
 GL019 II 394
 GL019 LG II 396
 GL019 ULG II 397
 GL038 II 405
 GL040 II 403
 GL040 ULG II 404
 GL100 II 414
 GL200 415
 GL200 415
 GLAM 90 164
 GLAM 250 165
 GLAM 265 164
 GLT1 408
 GLT2 409
 GLT3 410
 GUNZY 428
 GUNZY 2 P 430
 GUNZY 2 S 478
 GUNZY P 429
 GUNZY S 478
 GYRO 407
 GYRO A 407
 H2EXT 535

H

H2 PRO EXTREME CSP 535
 HAPPY 1 191
 HAPPY 2 192
 HAPPY 3 193
 HARRY A 495
 HB100 384
 HB101 384
 HB102 385
 HB108 383
 HD1050 30
 HD1050 R GU10 30

HD1070 30
 HD1070 R GU5.3 30
 HELLO 1 D 286
 HELLO 1 P 224
 HELLO 2 D 286
 HELLO 2 P 224
 HUBA P 226
 HUGO GU10 468
 HULA C 204
 HULA P 227
 HYB1 453
 HYDRA 453

I

IENA RDX 50
 IENA RDX-230 50
 ILY 505
 INDY 1 522
 INDY 1 A 523
 INDY 2 524
 INDY 2 A 525
 IPHO 82 RD 67
 IPHO 82 SD 67
 IPHO R GU10 AUTO 32
 IPHO S GU10 AUTO 32
 IRO 1 322
 IRO 2 322
 ITO 474
 IZA 1 SDX 120
 IZA 2 SDX 120

J

JACK 3 P 220
 JACK 3 T 292
 JACK 3 TP 294
 JACK T 272
 JACK TP 273
 JB1 565
 JB1 565
 JB2 566
 JB2 566
 JB4 567
 JB4 567
 JB5 568
 JB5 568
 JB6 569
 JB6 569
 JB7 570
 JB7 570
 JOY RX 97
 JUNE 1 C 206
 JUNE 1 P 228
 JUNE 2 C 206
 JUNE 2 P 228
 JUNE 3 C 207
 JUNE 3 P 229

K

KACI R-B 39
 KADRO E27 470
 KALA 539
 KALI R-230 B 38
 KARL 1 RDX 100
 KARL 2 RDX 100
 KARO 1 308
 KARO 2 308
 KARO 3 309
 KASA R GU10 24
 KASA RX GU10 24
 KAVA 162
 KC211R 39
 KO 703R 138

K

KO703R 138
 KO 703S 138
 KO703S 138
 KO2000 R 390
 KO2000 R GU10 390
 KOPA 490
 KORY R 62
 KORY R SENSOR 62
 KOS 1 S 492
 KOS 2 R 492
 KOS 2 S 493
 KU1479 162
 KUBO 491

L

LANTERN 485
 LARY RD 66
 LARY SD 66
 LASY RX 36
 LED9W 544
 LEDEP10 561
 LEDEP10 561
 LEGA D 320
 LEWIS 504
 LIDY 364
 LIDY A 366
 LIDY A SENSOR 366
 LIDY SENSOR 364
 LIKA 142
 LIMA 1 PLUS 296
 LIMA 2 PLUS 297
 LIMA 3 PLUS 298
 LINEA 1 300
 LINEA 2 300
 LINEAR 1 C 352
 LINEAR 1 P 354
 LINEAR 2 C 353
 LINEAR 2 P 356
 LISY RD 40
 LISY RDX 40
 LONGA 170
 LOOP 1 311
 LOOP 2 311
 LUPO 1 GU10 178
 LUXI 45 482
 LUXI 45 SENSOR 482
 LUXI 54 442
 LUXI 65 GU10 418
 LUXI 80 451
 LUXI 95 487
 LUXI 100 S 479
 LUXI 100 S P 448
 LUXI 120 R 471
 LUXI 120 S 471
 LUXI 139 484
 LUXI 175 SENSOR 483
 LUXI 175 SENSOR P 443
 LUXI 180 443
 LUXI 190 486
 LUXI 290 486
 LUXI 650 444
 LUZ 1 509
 LUZ 2 509
 LYON 1 R 115
 LYON 2 R 116
 LYON 3 R 117
 LYON 4 R 118

M

MAKA 143
 MALTA 1 169
 MALTA 2 169
 MANYL 2 179
 MANYL 2 GU10 179
 MARY RDX-230 46

MEKA 347
 MILO 1 158
 MILO 2 159
 MILO 3 160
 MILO 4 160
 MINI TIMY 361
 MINI TIMY E27 360
 MINI TIMY SENSOR 361
 MINI TIMY SENSOR E27 360
 MINO P E27 438
 MINO W E27 469
 MODU LED 544
 MOLY GU10 180
 MOWI RD 41

N

NOLY GU10 180
 NORA 494
 NOVA CSP 1 C 212
 NOVA CSP 1 P 234
 NOVA CSP 2 C 212
 NOVA CSP 2 P 234
 NOVA CSP 3 C 213
 NOVA CSP 3 P 235
 NV45 212
 NV60 212
 NV90 213

O

OKTO 1 C GU10 184
 OKTO 2 C GU10 185
 OKTO 2 GU10 149
 OKTO 3 T GU10 282
 OKTO 3 TP GU10 283
 OKTO 4 C GU10 186
 OKTO C GU10 183
 OKTO GU10 182
 OKTO P GU10 218
 OKTO RX GU10 87
 OKTO T GU10 270
 OKTO TP GU10 270
 OLA 1 420
 OLA 2 448
 ONEO A 495
 ONEX 317
 ORKI 369
 ORKI SENSOR 369
 OSIS 1 PLUS 289
 OSIS 2 PLUS 289
 OTIS 2 P 237
 OU105 486
 OU106 486
 OU108 418
 OU125 392
 OU135 484
 OU136 442
 OU138 444
 OU139 362
 OU143 479
 OU144 487
 OU145 471
 OU146 471
 OU150 481
 OU154 460
 OU158 460
 OU161 392
 OU168 390
 OU177 452
 OU185 478
 OU186 478
 OU187 429
 OU190 462
 OU206 482
 OU253 470
 OU310 468

OU318 443
 OU323 483
 OU324 451
 OU326 406
 OU328 534
 OU334 491
 OU336 449
 OU340 474
 OU342 539
 OU344 485
 OU345 423
 OU346 423
 OU350 462
 OU353 446
 OU354 442
 OU356 448
 OU357 444
 OU359 482
 OU360 480
 OU361 449
 OU363 487
 OU365 472
 OU367 443
 OU374 463
 OU375 481
 OU387 488
 OU390 456
 OU391 456
 OU395 361
 OU396 361
 OU397 369
 OU400 438
 OU407 469
 OU410 475
 OU411 406
 OU413 439
 OU414 439
 OU415 454
 OU417 369
 OU424 504
 OU425 407
 OU426 407
 OU427 413
 OU428 413
 OU431 488
 OU433 438
 OU434 469
 OU436 419
 OU438 490
 OU440 512
 OU441 513
 OU445 360
 OU446 360
 OU447 510
 OU448 510
 OU450 440
 OU451 440
 OU452 441
 OU453 495
 OU457 430
 OU458 428
 OU459 506
 OU460 506
 OU461 422
 OU463 454
 OU465 431
 OU467 485
 OU470 520
 OU474 521
 OU477 492
 OU478 493
 OU479 492
 OU481 448
 OU482 420
 OU486 398
 OU488 399
 OU489 509
 OU490 509
 OU492 494
 OU495 499
 OU497 431

O

OU498.....	532
OU499.....	532
OU501.....	495
OU502.....	474
OU503.....	447
OU504.....	502
OU505.....	502
OU507.....	445
OU508.....	466
OU509.....	466
OU510.....	467
OU511.....	467
OU512.....	505
OU513.....	473
OU514.....	473
OU517.....	424
OU518.....	424
OU519.....	425

P

P2A.....	128
P2B.....	132
P2C.....	133
PARO 1.....	312
PARO 2.....	313
PARO 3.....	314
PIXA 1.....	200
PIXA 2.....	200
PIXA 3.....	201
PK1.....	172
PK2.....	173
PLANK 1.....	172
PLANK 2.....	173
PLDUNIDRIVE350MA.....	551
PLDUNIDRIVE700MA.....	551
POL3.....	372
POLAS VERSA.....	372
POLO.....	499
PR115.....	254
PR115.....	254
PR117.....	256
PR117.....	256
PR121.....	257
PR121.....	257
PR127.....	258
PR127.....	258
PR130.....	259
PR130.....	259
PR133.....	261
PR133.....	261
PR135.....	262
PR135.....	262
PR137.....	263
PR137.....	263
PR139.....	255
PR139.....	255
PR146.....	260
PR146.....	260
PRO14.....	526
PRO32.....	526
PRO32A.....	527
PRO50.....	528
PRO50A.....	529
PSDAL350M.....	551
PSDAL700M.....	551
PSDIM350.....	551
PSDIM700.....	551
PSIP3509W.....	550
PSIP35018W.....	550
PSIP70018W.....	550
PSIP70036W.....	550
PU637WW.....	402
PURE 45.....	392
PURE 55.....	392
PURE 190.....	462
PURE 380.....	402

R

RAITO 1.....	344
RAITO 2.....	344
RAMA P.....	538
RAMA W.....	538
RAVEL.....	442
RAY.....	274
RAYPRO 14.....	526
RAYPRO 32.....	526
RAYPRO 32 A.....	527
RAYPRO 50.....	528
RAYPRO 50 A.....	529
RETI 1 RX.....	94
RETI 2 RX.....	94
RETI P.....	222
RETI W.....	152
RIESA.....	422
RIVA 2 GU10.....	187
RIVA 3 GU10.....	187
RIVA 4 GU10.....	188
RODI A.....	413
ROMY R GU10.....	502
ROMY S GU10.....	502
RONDO P E27.....	438
RONDO W E27.....	469

S

SANDO T.....	333
SANDO TP.....	333
SENSO R-230.....	104
SETO.....	449
SILK RDX.....	72
SILK RDX WARM.....	73
SIRA R.....	84
SIRA R SENSOR IR.....	84
SL040A.....	421
SL040A.....	421
SL220 MAINS II.....	432
SL230M.....	433
SL230 MAINS.....	433
SL240M.....	434
SL240 MAINS.....	434
SLIM.....	450
SLIT R.....	460
SLIT S.....	460
SM.....	450
SNOOP.....	150
SNOOP GU10.....	150
SOLIP.....	131
SOLIS 1.....	128
SOLIS 2.....	132
SOLIS 3.....	133
SOLIS IP65.....	131
SOLIS PRO.....	129
SOLIS PRO CSP.....	130
SOLP.....	129
SOLPCSP.....	130
SPBM.....	144
SPIRA 1 RX PLUS.....	122
SPIRA 3 RX.....	123
SPOTI R-B.....	37
SPOTTY 1 P.....	426
SPOTTY 1 W.....	476
SPOTTY 2 P.....	427
SPOTTY 2 W.....	477
SPOTTY 3 W.....	477
SPRINGBOK LITE 1.....	384
SPRINGBOK LITE 2.....	384
SPRINGBOK LITE 3.....	385
ST104.....	242
ST104.....	242
ST112.....	246
ST112.....	246
ST123.....	248
ST123.....	248
ST125.....	250
ST125.....	250
ST132.....	249
ST132.....	249

ST135.....	252
ST135.....	252
ST150.....	243
ST150.....	243
ST153.....	244
ST153.....	244
ST156.....	245
ST156.....	245
ST159.....	247
ST159.....	247
ST160.....	251
ST160.....	251
STELLA.....	446
STEPBEAM.....	144
SU153.....	230
SU154.....	230
SU155.....	231
SU156.....	228
SU157.....	228
SU158.....	236
SU159.....	236
SU160.....	218
SU161.....	220
SU163.....	229
SU164.....	232
SU165.....	232
SU166.....	224
SU167.....	224
SU168.....	237
SU169.....	219
SU170.....	234
SU171.....	234
SU172.....	235
SU173.....	222
SU174.....	227
SUP08.....	545
SUP 08 AUTO.....	545
SWEET RD EVO.....	70
SWIM.....	398
SYLA RD-B.....	75

T

TED.....	290
THEA LITE CSP 1.....	108
THEA LITE CSP 2.....	109
THEA LITE CSP 3.....	110
THEA PRO 1.....	113
THEA PRO 2.....	114
THL1.....	108
THL2.....	109
THL3.....	110
THP1.....	113
THP2.....	114
TIBLI R-B.....	36
TIGA 1 RD.....	106
TIGA 2 RD.....	106
TIGA 3 RD.....	107
TILT 1.....	408
TILT 2.....	409
TILT 3.....	410
TILT 4.....	411
TILT 5.....	412
TIMY.....	362
TIMY SENSOR.....	362
TINY R.....	390
TIPI RX.....	42
TIPI SX.....	42
TIPO 1 C.....	202
TIPO 2 C.....	202
TOMA.....	343
TOMO.....	343
TOMY 1 C.....	215
TOMY 1 P.....	236
TOMY 2 P.....	236
TONKA.....	335
TORO T.....	332
TORO TP.....	332
TP1139.....	362

T

TR220 278
 TR240 304
 TR260 306
 TR267 318
 TR270 316
 TR279 319
 TR283 317
 TR284 312
 TR287 313
 TR300 314
 TR311 322
 TR312 322
 TR357 300
 TR358 300
 TR359 280
 TR360 308
 TR361 308
 TR362 309
 TR364 320
 TR376 320
 TR389 286
 TR390 286
 TR391 311
 TR392 311
 TR393 291
 TR395 296
 TR397 297
 TR399 298
 TR401 266
 TR418 274
 TR419 270
 TR420 270
 TR422 282
 TR423 283
 TR424 292
 TR426 294
 TR428 272
 TR429 273
 TR431 268
 TR432 268
 TR433 284
 TR434 285
 TR435 290
 TR437 291
 TR438 289
 TR439 289
 TR445 344
 TR446 344
 TR447 345
 TR448 345
 TR449 346
 TR450 346
 TR451 347
 TR452 336
 TR453 337
 TR454 343
 TR455 343
 TR456 333
 TR457 333
 TR458 334
 TR459 339
 TR460 340
 TR461 341
 TR462 342
 TR463 339
 TR464 340
 TR465 341

TR466 342
 TR467 338
 TR468 335
 TR469 332
 TR470 332
 TR471 328
 TR474 330
 TR474 331
 TR477 326
 TRACK 48VDC RECESSED 306
 TRACK 48VDC SURFACE 304
 TRACK III SURFACE 278
 TRACK III SURFACE 279
 TRACK UNO 266
 TRACK UNO 267
 TULO E27 439
 TULO SENSOR E27 439
 TURA GU10 419

U

UNIS R 506
 UNIS S 506

V

VIGO 316
 VITEL GX53 148

W

WA110 164
 WA112 158
 WA128 166
 WA129 169
 WA132 200
 WA133 200
 WA134 201
 WA164 169
 WA165 159
 WA169 163
 WA173 142
 WA174 143
 WA175 164
 WA176 165
 WA179 202
 WA180 170
 WA182 197
 WA183 197
 WA194 180
 WA195 176
 WA196 176
 WA197 180
 WA198 181
 WA199 187
 WA200 187
 WA201 188
 WA202 179
 WA203 178
 WA210 179
 WA215 160

WA216 208
 WA217 209
 WA218 210
 WA222 206
 WA223 206
 WA224 215
 WA229 182
 WA230 183
 WA231 184
 WA232 185
 WA233 186
 WA234 149
 WA235 160
 WA236 168
 WA237 168
 WA238 191
 WA239 192
 WA240 193
 WA241 207
 WA242 211
 WA243 211
 WA248 214
 WA252 167
 WA253 148
 WA254 148
 WA256 195
 WA257 196
 WA258 154
 WA259 155
 WA260 156
 WA261 150
 WA262 150
 WA263 157
 WA264 152
 WALLY A 399
 WC59 564
 WC59 564
 WCR275BLACK 546
 WCR275BLACK 546
 WIDO 475
 WL94 368
 WL94 368

Y

YERA 1 T GU10 268
 YERA 1 TP GU10 268
 YERA GU10 280
 YOKA 1 339
 YOKA 2 340
 YOKA 3 341
 YOKA 4 342
 YOKO 1 339
 YOKO 2 340
 YOKO 3 341
 YOKO 4 342
 YUKA 431
 YUKO GU10 181

Z

ZUMU 338



0 1 2 3 4 5 6 7 8 9 10 11 12 13 14 15 16 17 18 19 20 21 22 23 24 25 26 27 28

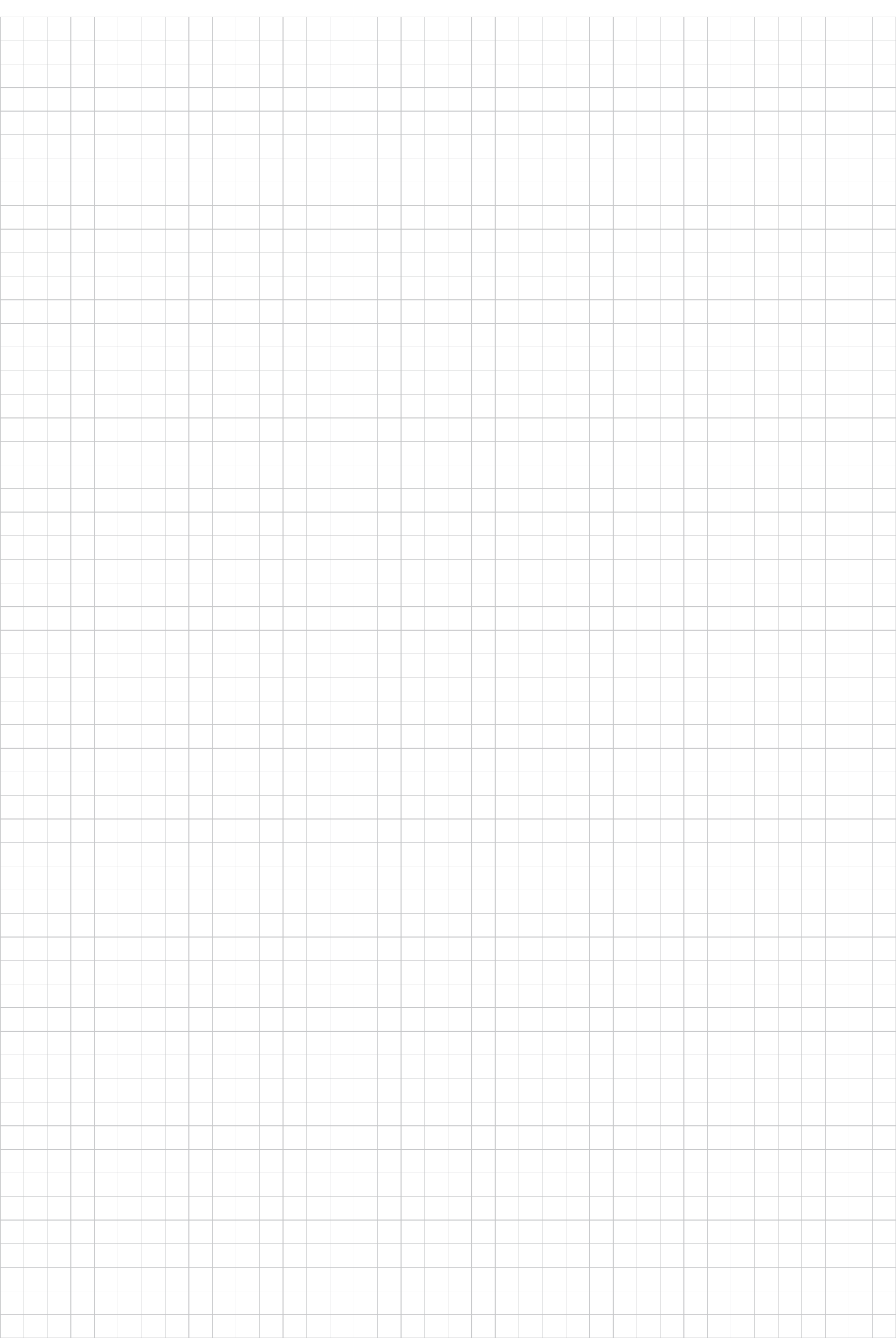

0 1 2 3 4 5 6 7 8 9 10 11 12 13 14 15 16 17 18 19 20 21 22 23 24 25 26 27 28

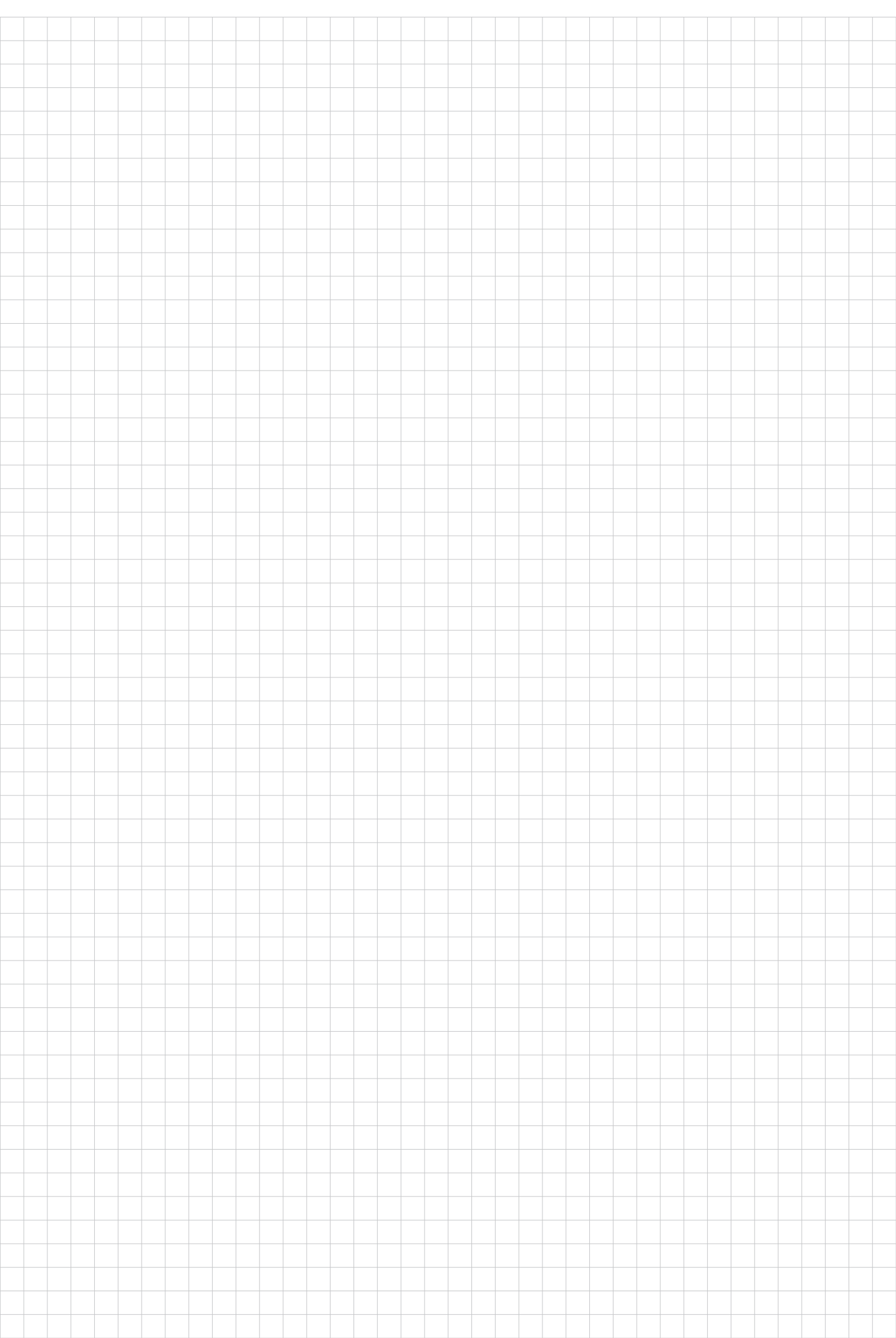

0 1 2 3 4 5 6 7 8 9 10 11 12 13 14 15 16 17 18 19 20 21 22 23 24 25 26 27 28



0 1 2 3 4 5 6 7 8 9 10 11 12 13 14 15 16 17 18 19 20 21 22 23 24 25 26 27 28



28
27
26
25
24
23
22
21
20
19
18
17
16
15
14
13
12
11
10
9
8
7
6
5
4
3
2
1
0

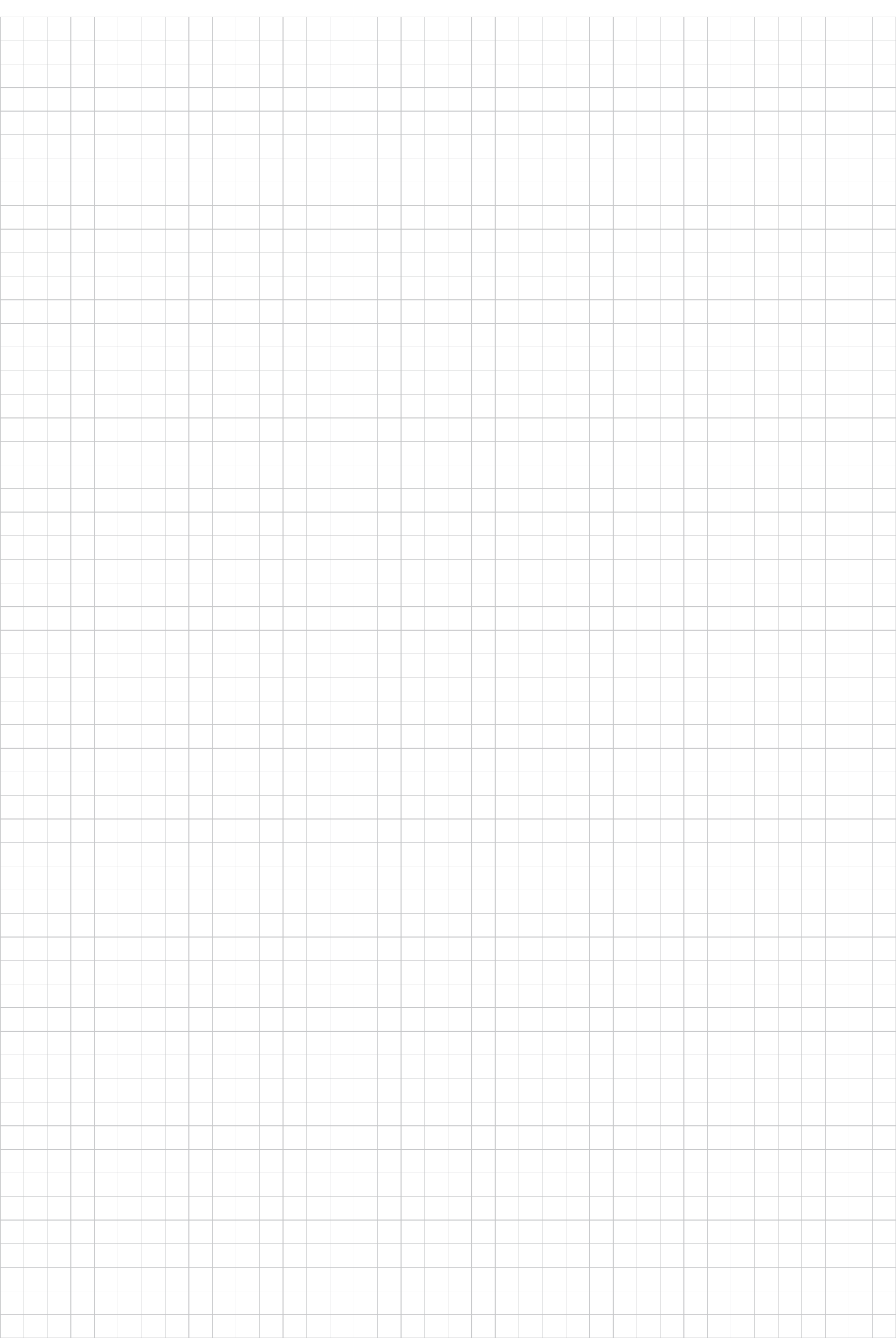

28
27
26
25
24
23
22
21
20
19
18
17
16
15
14
13
12
11
10
9
8
7
6
5
4
3
2
1
0

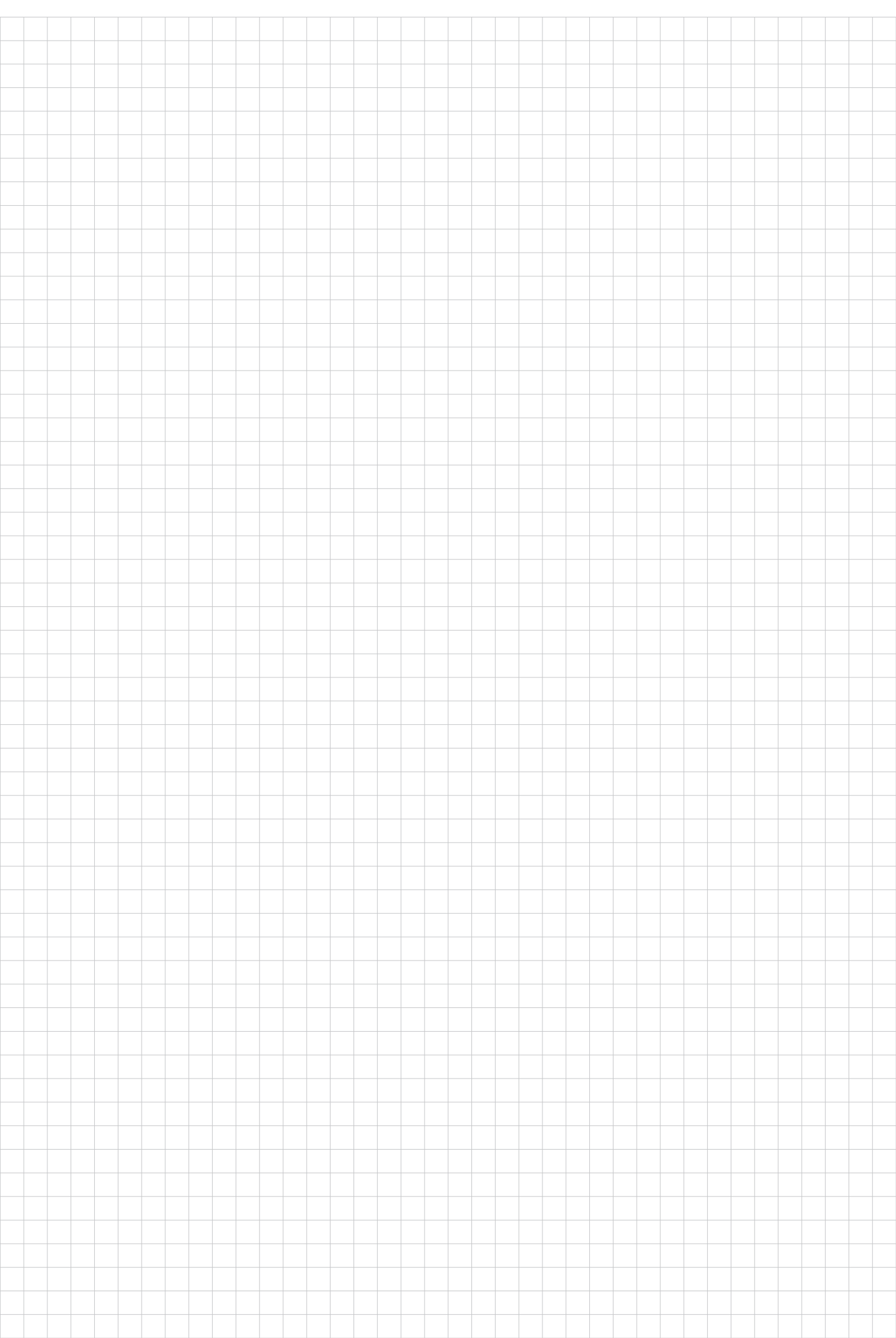

28
27
26
25
24
23
22
21
20
19
18
17
16
15
14
13
12
11
10
9
8
7
6
5
4
3
2
1
0



0 1 2 3 4 5 6 7 8 9 10 11 12 13 14 15 16 17 18 19 20 21 22 23 24 25 26 27 28



0 1 2 3 4 5 6 7 8 9 10 11 12 13 14 15 16 17 18 19 20 21 22 23 24 25 26 27 28

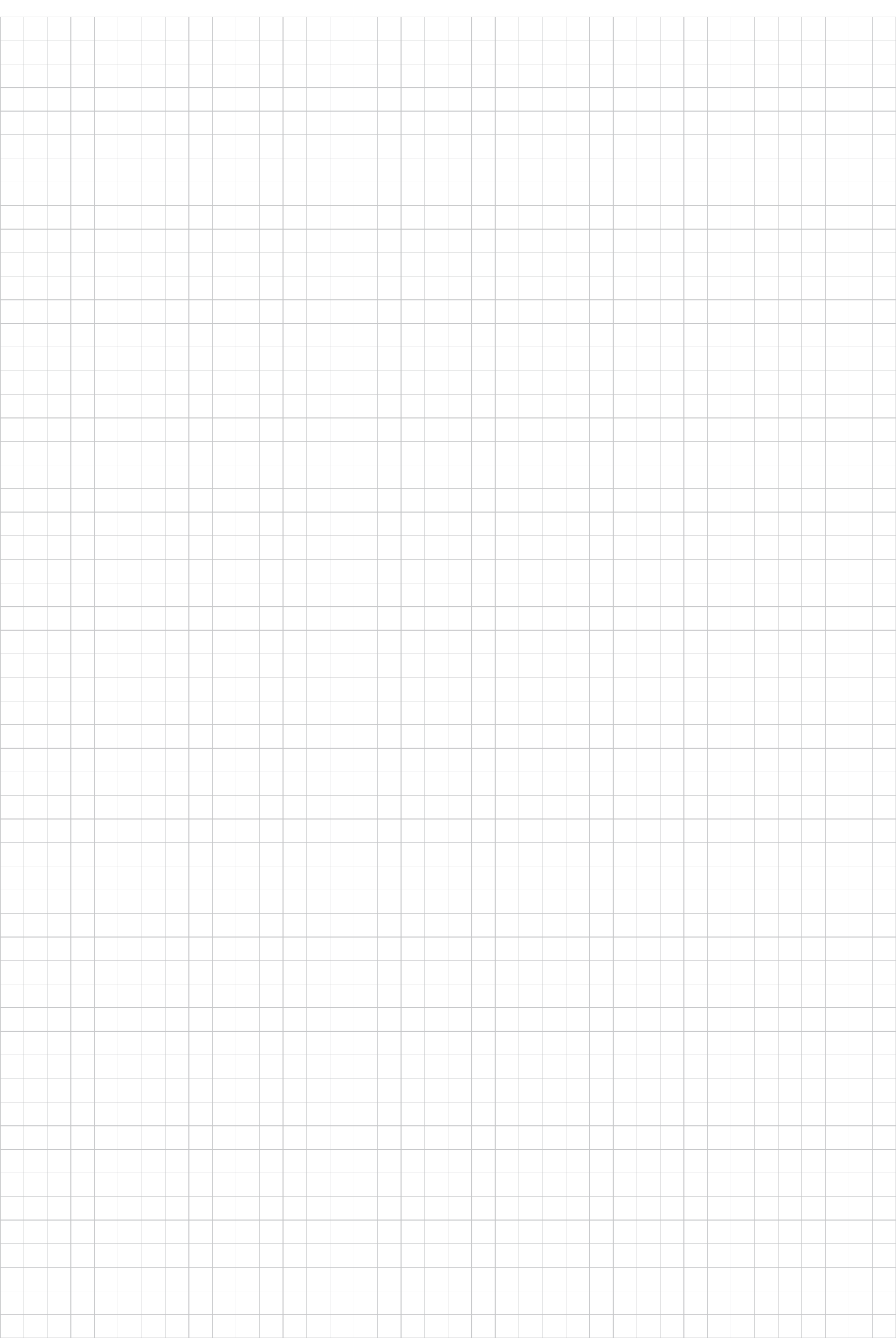

0 1 2 3 4 5 6 7 8 9 10 11 12 13 14 15 16 17 18 19 20 21 22 23 24 25 26 27 28

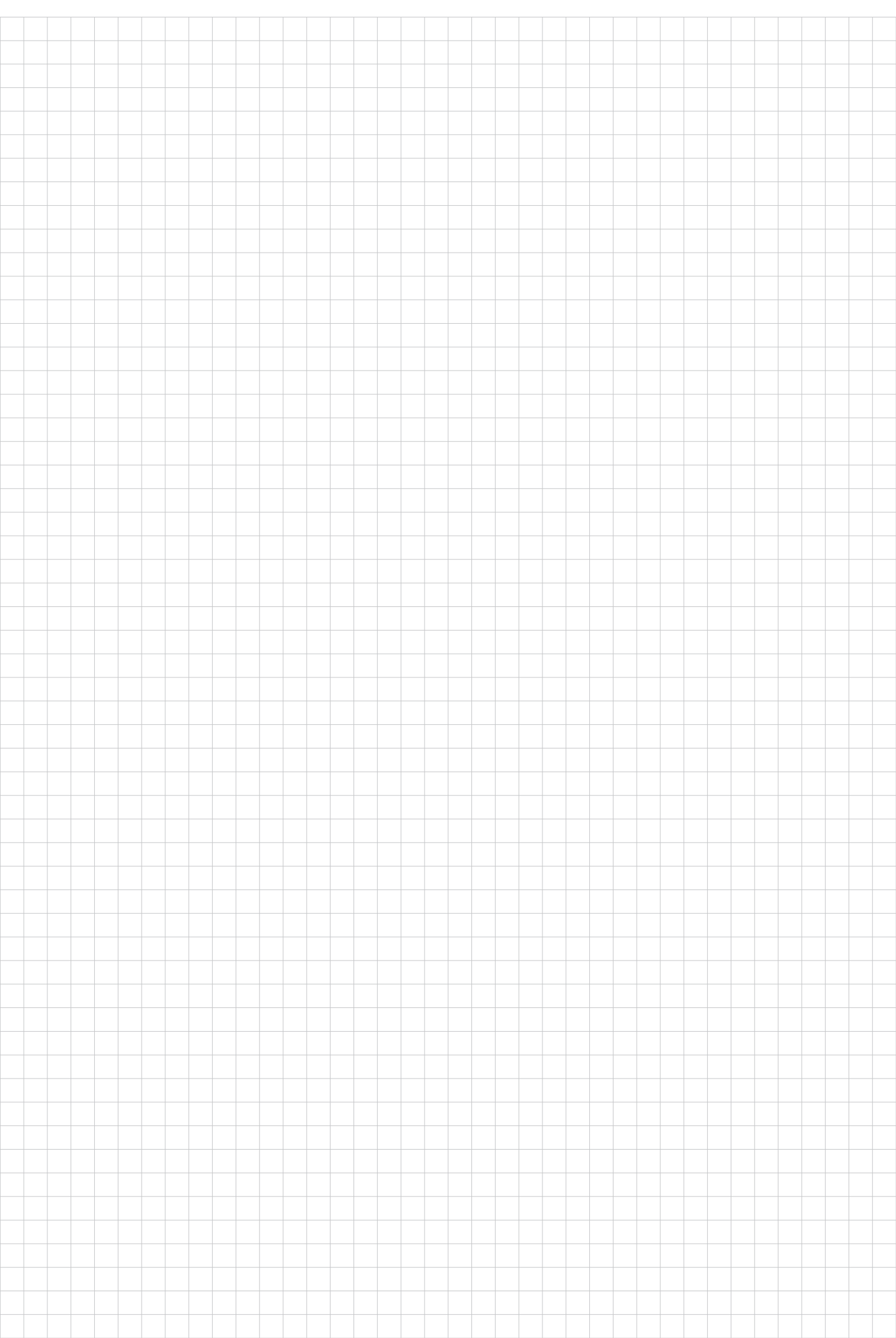

0 1 2 3 4 5 6 7 8 9 10 11 12 13 14 15 16 17 18 19 20 21 22 23 24 25 26 27 28



28
27
26
25
24
23
22
21
20
19
18
17
16
15
14
13
12
11
10
9
8
7
6
5
4
3
2
1
0



0 1 2 3 4 5 6 7 8 9 10 11 12 13 14 15 16 17 18 19 20 21 22 23 24 25 26 27 28



INDIGO

LIGHTING

INDIGO S. A.

Parc Artisanal de Cornemont
Rue de la Légende 32G
4141 Sprimont
BELGIQUE

T : +32 (0)4 351 91 40
F : +32 (0)4 351 91 41
info@indigo-lighting.com

indigo-lighting.com



INDIGO

LIGHTING

indigo-lighting.com